

1

WORKS OF  
EDWARD WEGMANN, C.E.,

PUBLISHED BY

JOHN WILEY & SONS.

---

**The Water-supply of the City of New York from  
1658 to 1895.**

Profusely illustrated with half-tones and figures in the  
text, and folding-plates. 4to, cloth, \$10.00.

**The Design and Construction of Dams.**

Including Masonry, Earth, Rock-fill, Timber and Steel  
Structures; also, the Principal Types of Movable Dams.  
Profusely illustrated with 120 figures in the text and 133  
plates, including folders and half-tones. 4to, cloth, \$6.00.

1

2

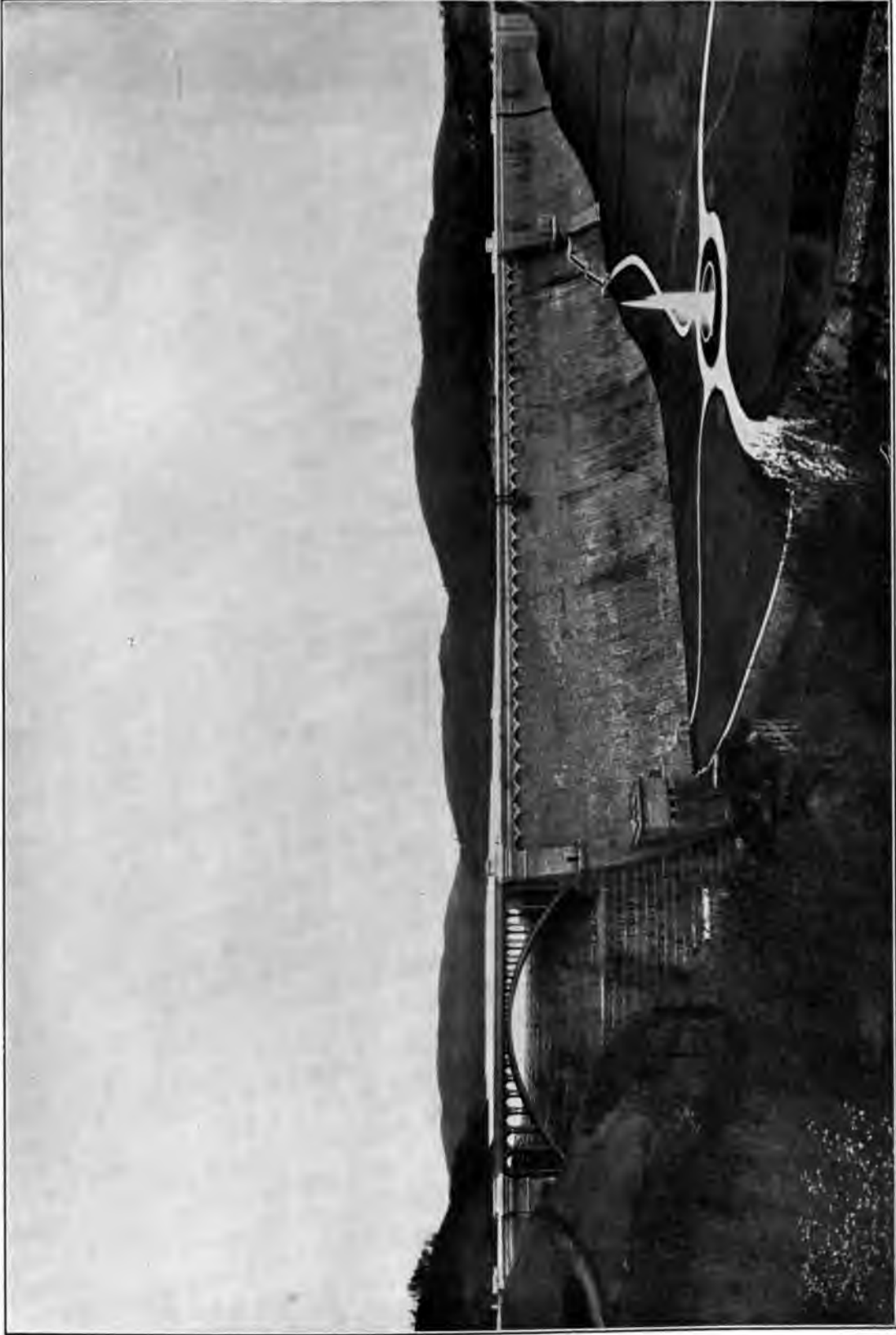
3

4

5

6

7



NEW CROTON DAM.



THE DESIGN  
AND  
CONSTRUCTION OF DAMS

INCLUDING  
MASONRY, EARTH, ROCK-FILL, TIMBER,  
AND STEEL STRUCTURES

ALSO  
THE PRINCIPAL TYPES OF MOVABLE DAMS

BY  
EDWARD WEGMANN, C.E.

M. AM. SOC. C. E.

*Author of "The Water-Supply of the City of New York, 1658-1895"*

*FIFTH EDITION, REVISED AND ENLARGED*  
FIRST THOUSAND

NEW YORK  
JOHN WILEY & SONS  
LONDON: CHAPMAN & HALL, LIMITED  
1908

COPYRIGHT, 1899, 1907,  
BY  
EDWARD WEGMANN.

The Scientific Press  
Robert Drummond and Company  
New York

02-18-07 (11 5.3)

## PREFACE TO THE FIRST EDITION

---

THE great advantages to be derived from large storage reservoirs, built for regulating the flow of a river, for irrigation purposes, or for domestic water supply, have led within recent years to the construction of a large number of such works in various parts of the world. Where water having great depth is to be retained, it would be extremely hazardous to rely on earthen dams, as numerous failures of such works have been recorded and walls of masonry are, therefore, employed.

The successful completion of the Furens Dam (164 feet high) in 1866 was soon followed by that of many similar structures in France, Algiers, and Italy. In the United States a concrete dam (170 feet high) is being built near San Francisco; the Sodom Dam (70 feet high) has been commenced on the East Branch of the Croton River; and the Quaker Bridge Dam, which will surpass all existing dams in height, has been designed to form an immense storage reservoir for the city of New York.

While the practical importance of the subject of masonry dams seems to be steadily growing, the engineer who may be entrusted with the design of such works will find the theoretical study of the best form of profile for a masonry dam very disheartening. How widely the types proposed by eminent engineers differ from each other is shown on Plate A, page 43.

The theory of masonry dams is based upon a few simple principles and conditions; the mathematics, however, to which they give rise, when applied to the design of an economical profile, are rather appalling. Thus, if we follow the methods of the French engineers Sazilly and Delocre, we have to solve lengthy equations, some of them of the sixth degree. Moreover, there is always an uncertainty which equation is to be used, and the only way of determining this is by trial. If we wish to employ the method of Prof. Rankine, but change the data assumed by him, we have to make trials with the subtangent of a logarithmic curve. In contradistinction to these scientific methods, we find prominent engineers recommending trial calculations as the best practical solution of the problem.

The writer, when detailed by the Chief Engineer of the New Croton Aqueduct to make calculations for the proposed Quaker Bridge Dam, the height of which is to be 270 feet, after studying the existing methods of designing profiles and finding them for various reasons inapplicable to the case in view, finally arrived at the equations given in this book. They are easy to solve, being, with the exception of one cubic equation, of the first or second degree. The theoretical section of the Quaker Bridge Dam was calculated by these equations. As the construction of this gigantic dam,

which is likely to be commenced soon, may lead many persons to inquire how its profile was determined, the writer has thought that a book giving the details of the method employed, and information about masonry dams in general, might be of interest and practical value to engineers. It is with this view that the present work has been undertaken.

The text has been illustrated by numerous Plates and Tables, showing the form and strength of the various profiles discussed. Data of forty-four existing masonry dams have been collected in Table XXIII.

The investigations given in Chapter IV., relating to the effect of the weight of masonry upon the form of profile and the calculations for inclined joints, were suggested in connection with the proposed Quaker Bridge Dam by Mr. B. S. Church, Chief Engineer, and Mr. A. Fteley, Consulting Engineer.

In the preparation of this book the writer has been assisted by some of the engineers of the New Croton Aqueduct, who have become interested in these studies, and he wishes to express herewith his thanks to Mr. H. C. Alden and Mr. M. A. Viele, who have helped him to calculate the Tables, and to Mr. G. Bonanno and Mr. I. A. Shaler, who have rendered valuable aid in making the drawings and in collecting information about existing dams.

E. W., JR.

NEW YORK, April, 1888.

---

### PREFACE TO THE THIRD EDITION.

---

SINCE the first edition of this work was published, the project of constructing a dam across the Croton Valley near the Quaker Bridge has been abandoned, another site, about  $1\frac{1}{2}$  miles further up-stream, having been selected for the proposed structure. As the profile adopted for this reservoir wall is, however, practically the same as the one designed for the proposed Quaker Bridge Dam, the studies made for the latter, which are given in this book, may still be of interest.

The only change which has been made, therefore, in the present edition of this work has been to add a new Chapter and additional Plates, in order to bring the descriptions given of dams constructed up to date.

E. W., JR.

NEW YORK, Sept. 1, 1893.

## PREFACE TO THE FOURTH EDITION.

---

THE first Part of this work was published in 1888 as a treatise on "The Design and Construction of Masonry Dams." It contains the results of the studies made by the author while engaged in making calculations for the design of the proposed Quaker Bridge Dam, and information about high masonry dams built in various countries. The book passed through three editions, the only changes made being the addition of an extract from the report of the experts who investigated the designs for the Quaker Bridge Dam, and of descriptions of dams recently constructed, in order to bring the information on this subject up to date. In the present edition the work has been enlarged so as to include the whole subject of dams, viz., masonry, earth, rock-fill, and timber structures, and, also, the principal types of movable dams.

The author has endeavored to add to the practical interest of the original book, which forms Part I of the present work, by inserting half-tones in the text, giving detailed descriptions and drawings of some of the high masonry dams recently built to form storage reservoirs for the water-supply of the city of New York, and by placing in the Appendix the specifications for the New Croton Dam, which will be by far the highest structure of its kind. To illustrate fully the manner in which the profile of this dam was calculated by the method explained in Part I, Chapter III, a practical example of the application of the equations used for this purpose has been given in the Appendix.

The subjects of earth, rock-fill, and timber dams are discussed in Part II. The principal types of movable dams are described in Part III. Since 1839 internal navigation in France has been much improved by means of structures of this kind. Thus far only a few movable dams have been built in the United States. As this subject has been attracting much attention in America of late, the author has thought it advisable to include it in the present edition.

The information given in this volume has been gathered from many sources. The authorities consulted are given in the Appendix (p. 239). The sources from which the illustrations in the book were obtained are generally mentioned in the text. The half-tones of the Furens and Vyrnwy dams were reproduced from plates contained in a report on high masonry dams, by Mr. George W. Rafter, which was included in the Annual Report for 1897 of the Engineer and Surveyor of the State of New York. In Plate B, photographs of the Gileppe Dam, which were kindly loaned the author by Mr. Alphonse Fteley, the Chief Engineer of the Aqueduct Commission of New York, are reproduced. Figs. 39 and 54 were taken from Mahan's "Civil Engineering." Figs. 19 to 21 and 23 were obtained from the 18th Annual Report of the U. S. Geological Survey. The author wishes to acknowledge here his obligation to Mr. F. H. Newell, the hydrographer of this survey, who kindly furnished him with electrotypes of all the plates and figures contained in the reports of the U. S. Geological Sur-

v

vey which have been reproduced in this book. He wishes, also, to express his thanks to Mr. Edward A. Bond, State Engineer of New York, who enabled him to obtain electrotypes of Plates A and C.

The author hopes that the new matter added to the book will increase its usefulness and that it may be of practical help to members of the profession who cannot avail themselves of the information contained in large technical libraries.

E. W.

NEW YORK, July 1, 1899.

THE first impressions of the Fourth Edition having been exhausted, the writer has added to this edition descriptions of the Rosetta, Damietta, Assuan, and Assiout dams across the Nile and, also, a short account of the failure of the Austin Dam.

E. W.

NEW YORK, April 1, 1904.

---

## PREFACE TO THE FIFTH EDITION.

---

IN preparing the Fifth Edition of this book, the whole work has been thoroughly revised with the view of bringing the information contained as much as possible up to date. The newest theories proposed for the design of masonry dams have been mentioned in the Introduction. The chapter on the construction of masonry dams has been entirely rewritten. Descriptions of all important dams built or in course of construction, of which the author could find any record, have been given, and in the cases of the New Croton Dam, the highest masonry dam thus far built, and of other noteworthy reservoir walls the construction has been described with considerable detail. The text has been illustrated by numerous plates and figures.

Among the new matter added to the book are descriptions of steel and concrete-steel dams, high earth dams, Stoney sluice-gates, and rolling dams. In the present edition the work contains 93 pages of reading-matter, 39 plates, and 45 figures more than appeared in the Fourth Edition.

The information given has been gathered from many sources, partly from printed records and partly by correspondence. The author wishes to acknowledge here his indebtedness to the many engineers who have assisted him by supplying desired data about dams, and he has endeavored to give due credit for such assistance in the text of the book.

The preparation of this edition has involved much work, and the author hopes that the many hours spent on the revision may have added to the practical value of the book.

E. W.

# CONTENTS.

## PART I.

### *DESIGN AND CONSTRUCTION OF MASONRY DAMS.*

	PAGE
CHAPTER I.	
INTRODUCTION, . . . . .	. . . . .
CHAPTER II.	
DISTRIBUTION OF PRESSURE IN A WALL OF MASONRY, . . . . .	11
CHAPTER III.	
THEORETICAL PROFILES, . . . . .	18
CHAPTER IV.	
VARIOUS APPLICATIONS OF EQUATIONS (1) TO (14), . . . . .	28
CHAPTER V.	
PRACTICAL PROFILES, . . . . .	34
CHAPTER VI.	
CONSTRUCTION, . . . . .	46
CHAPTER VII.	
SPANISH DAMS, . . . . .	54
CHAPTER VIII.	
FRENCH DAMS, . . . . .	63
CHAPTER IX.	
DAMS IN VARIOUS PARTS OF EUROPE, . . . . .	79
CHAPTER X.	
DAMS IN ALGIERS, . . . . .	94
CHAPTER XI.	
DAMS IN EGYPT, . . . . .	101
CHAPTER XII.	
DAMS IN ASIA AND AUSTRALASIA, . . . . .	116
CHAPTER XIII.	
AMERICAN DAMS, . . . . .	128
CHAPTER XIV.	
REINFORCED CONCRETE DAMS, . . . . .	210

## PART II.

*EARTHEN, ROCK-FILL, TIMBER, AND STEEL DAMS.*

	CHAPTER I.	PAGE
EARTHEN DAMS, . . . . .		221
	CHAPTER II.	
DAMS MADE BY THE HYDRAULIC PROCESS, . . . . .		248
	CHAPTER III.	
ROCK-FILL DAMS, . . . . .		266
	CHAPTER IV.	
TIMBER DAMS, . . . . .		280
	CHAPTER V.	
STEEL DAMS, . . . . .		294

## PART III.

*MOVABLE DAMS.*

	CHAPTER I.	
FRAME DAMS, . . . . .		301
	CHAPTER II.	
SHUTTER DAMS, . . . . .		325
	CHAPTER III.	
DAMS WITH BEAR-TRAP GATES, . . . . .		344
	CHAPTER IV.	
STONEY ROLLER SLUICE-GATES, ROLLING DAMS, AND BUTTERFLY DAMS, . . . . .		351
	CHAPTER V.	
RECENT MOVABLE DAMS, . . . . .		363

## APPENDIX.

SPECIFICATIONS FOR THE NEW CROTON DAM, . . . . .	367
NOTES A, B, AND C, . . . . .	385
TABLES I TO XXV, . . . . .	388
CALCULATION OF THEORETICAL PROFILE No. 6, . . . . .	403
BIBLIOGRAPHY, . . . . .	405
INDEX, . . . . .	415



## LIST OF PLATES.

---

		<i>Page</i>
Frontispiece. New Croton Dam.		
Plate	A. Comparison of Profiles.....	43
	B. Furens Dam.....	67
	C. Gileppe Dam.....	83
	D. Vyrnwy Dam.....	85
	E. Assuan Dam.....	105
	F. Assuan Dam.....	107
	G. Assiout Dam.....	111
	H. Assiout Dam.....	113
	I. San Mateo Dam.....	131
	J. Bear Valley Dam.....	133
	K. Sweetwater Dam.....	137
	L. Soçôm Dam.....	147
	M. Titicus Dam.....	149
	N. New Croton Dam.....	165
	O. New Croton Dam in Construction.....	167
	P. " " " " " ".....	171
	Q. " " " " " ".....	173
	R. " " " " " ".....	179
	S. " " " " " ".....	181
	T. Wachusett Dam.....	187
	U. Shoshone Dam.....	205
	V. Juniata Dam.....	215
	W. Juniata Dam.....	217
	X. La Mesa Dam.....	249
	Y. Zuni Dam.....	261
	Z. Escondido Dam.....	267
	AA. Lower Otay Dam.....	271
	BB. Ash Fork and Redridge Dams.....	295
	CC. Hauser Lake Dam.....	299
	DD. Big Sandy River Dam.....	311
	EE. Beznau Dam.....	35
	FF. Hagneck Dam.....	355
	GG. Rolling Dam at Schweinfurt.....	359

Plate I. De Sazilly's Profile-type.
II. Delocre's Profile-type.
III. Prof. Rankine's Profile-type.
IV. Comparison of Rankine's Profile with the Theoretical Profile.
V. Krantz's Profile-type.
VI. Prof. Harlacher's Profile-type.
VII. Crugnola's Profile-type.
VIII. Theoretical Profile No. 1.
IX. Theoretical Profile No. 2.
X. Comparison of Theoretical Profiles.
XI. Theoretical Profile No. 5 with Inclined Joints.
XII. Theoretical Profile No. 5, modified by Bouvier's formulæ.
XIII. Theoretical Type No. I.
XIV. Practical Type No. 1.
XV. Theoretical Type No. II.
XVI. Practical Type No. 2.

Plate XVII. Practical Profile No. 1.
XVIII. Practical Profile No. 2.
XIX. Practical Profile No. 3.
XX. Stability of Practical Profile, No. 3, found by Graphic Statics.
XXI. Almanza Dam.
XXII. Alicante Dam.
XXIII. Elche Dam.
XXIV. Puentes Dam.
XXV. Val de Infierno Dam.
XXVI. Nijar Dam.
XXVII. Lozoya Dam.
XXVIII. Villar Dam.
XXIX. Hajar Dam.
XXX. Lampy Dam.
XXXI. Vioreau Dam.
XXXII. Bosmelea Dam.
XXXIII. Glomel Dam.

- Plate XXXIV. Gros-Bois Dam.  
 XXXV. Zola Dam.  
 XXXVI. Furens Dam.  
 XXXVII. Ternay Dam.  
 XXXVIII. Ban Dam.  
 XXXIX. Verdon Dam.  
 XL. Bouzey Dam.  
 XLI. Pont Dam.  
 XLII. Chartrain Dam.  
 XLIII. Mouche Dam.  
 XLIV. Turdine and Miodeix Dams.  
 XLV. Cagliari Dam.  
 XLVI. Gorzente Dam.  
 XLVII. Komotau and Lagolungo.  
 XLVIII. Gileppe Dam.  
 XLIX. Vyrwy Dam.  
   L. Habra Dam.  
   LI. Tielat Dam.  
   LII. Djidionia Dam.  
   LIII. Gran Cheurfas Dam.  
   LIV. Hamiz Dam.  
   LV. Assuan Dam.  
   LVI. Poona Dam.  
   LVII. Tansa Dam.  
   LVIII. Periar Dam.  
   LIX. Geelong Dam.  
   LX. Tytam Dam.  
   LXI. Boyd's Corners Dam.  
   LXII. Bridgeport Dam.  
   LXIII. Wigwam Dam.  
   LXIV. San Mateo Dam.  
   LXV. Bear Valley Dam.  
   LXVI. Sweetwater Dam.  
   LXVII. Hemmet Dam.  
   LXVIII. Colorado Dam.
- Plate LXIX. Sodom Dam.  
   LXX. Titicus Dam, Plan.  
   LXXI. Titicus Dam, Elevation.  
   LXXII. Titicus Dam, Profile.  
   LXXIII. Titicus Dam, Profile at Gate House.  
   LXXIV. Titicus Dam, Overflow.  
   LXXV. Titicus Dam, Flume.  
   LXXVI. Old Croton Dam.  
   LXXVII. Quaker Bridge Dam, Department of Public Works' Plan.  
   LXXVIII. Quaker Bridge Dam, Aqueduct Commissioners' Plan.  
   LXXIX. Quaker Bridge Dam, Experts' Plan.  
   LXXX. New Croton Dam, Plan.  
   LXXXI. New Croton Dam, Elevation.  
   LXXXII. New Croton Dam, Profile.  
   LXXXIII. New Croton Dam, Overflow.  
   LXXXIV. Wachusett and Spier Falls Dams.  
   LXXXV. Details of Wachusett Dam.  
   LXXXVI. Boonton Dam.  
   LXXXVII. Boonton and Spier Falls Overflows.  
   LXXXVIII. Roosevelt and Cheesman Lake Dams.  
   LXXXIX. Shoshone and Pathfinder Dams.  
   XC. Cross River Dam.  
   XCI. Croton Falls Dam.  
   XCII. Outlet Tower, Vehar Reservoir, Bombay.  
   XCIII. Yarrow Dam, Liverpool Water-works.  
   XCIV. Earthen Dams for Water-works of New York.  
   XCV. Belle Fourche Dam.  
   XCVI. Crib-dams in Pennsylvania.  
   XCVII. Holyoke Dam.  
   XCVIII. Ash Fork Steel Dam.  
   XCIX. Redridge Steel Dam.  
   C. Stoney Roller Sluice-gate for Beznau Dam.

## LIST OF FIGURES IN TEXT.

---

FIG.	PAGE
1. Profile of a Dam according to De Sazilly, etc. ....	7
2. Profile of a Dam illustrating Guillemain's Method. ....	7
3. Profile of a Dam illustrating Hétier's Method. ....	8
4. Diagram illustrating Clavenad's Method. ....	8
5. Atcherley's Models of Dams. ....	9
6. Distribution of Pressure in a Masonry Wall. ....	13
7. Distribution of Pressure in a Masonry Wall. ....	13
8. Distribution of Pressure in a Masonry Wall. ....	13
9. Distribution of Pressure in a Masonry Wall. ....	13
10. Distribution of Pressure in a Masonry Wall. ....	14
11. Distribution of Pressure in a Masonry Wall. ....	15
12. Distribution of Pressure in a Masonry Wall. ....	15
13. Distribution of Pressure in a Masonry Wall. ....	16
14. Distribution of Pressure in a Masonry Wall. ....	17
15. Diagram for Equations in Chapter III. ....	19
16. Diagram for Equations in Chapter III. ....	20
17. Diagram for Equations in Chapter III. ....	22
18. Diagram for Equations in Chapter III. ....	22
19. Diagram for Equations in Chapter III. ....	23
20. Diagram for Check Calculations. ....	27
21. Triangular Profile. ....	37
22. Sluice-gate. ....	51
23. Sluice-gate Standard with Ball-bearings. ....	51
24. Tapered Rollers for Sluice-gate Standard. ....	52
25. Sluice-gate Standard with Tapered Rollers. ....	52
26. Avignonet Dam. ....	75
27. Sioule Dam. ....	75
28. Echapre Dam. ....	77
29. Cher Dam. ....	78
30. Urft Dam. ....	91
31. Meer Allum Dam. ....	124
32. Barossa Dam. ....	126
33. La Grange Dam. ....	140
34. Folsom Dam. ....	141
35. Maximum Section of New Croton Dam. ....	176
36. Gatehouse No. 1 of New Croton Dam. ....	176
37. Gatehouse No. 2 of New Croton Dam. ....	177
38. Balanced Valve for New Croton Dam. ....	177
39. Cheesman Lake Dam. ....	198
40. Ithaca Dam. ....	200
41. Ithaca Dam. ....	201
42. Concrete-steel Dam with Open Front. ....	211
43. Concrete-steel Curtain-dam. ....	211
44. Concrete-steel Apron-dam. ....	212
45. Concrete-steel Half-apron Dam. ....	212
46. Proposed Concrete-steel Dam with Power-house. ....	213
47. Cross-section of Dam shown in Fig. 47. ....	213
48. Profile for Concrete-steel Dams. ....	214
49. Schuylerville Dam. ....	219
50. Separating Weir. ....	227
51. Outlet from Reservoir. ....	230
52. Ashti Dam. ....	234

FIG.	PAGE
53. San Leandro Dam.....	238
54. Pilareitos Dam.....	239
55. San Andres Dam.....	239
56. Tabeaud Dam.....	240
57. Cross-section of La Mesa Dam.....	251
58. Zuni Dam.....	263
59. Tenango Dam.....	264
60. Tenango Dam.....	264
61. Necaxa Dam No. 2.....	265
62. Sketch of Reconstruction of Chatsworth Park Rock-fill Dam.....	273
63. Pecos Valley Dam No. 1.....	274
64. Pecos Valley Dam No. 2.....	274
65. Castlewood Dam.....	276
66. Diagram of Timber Dam.....	280
67. Diagram of Timber Dam.....	280
68. Diagram of Timber Dam.....	280
69. Log Dam.....	282
70. Crib-dam.....	283
71. Pile-dam.....	284
72. Plank-dam.....	285
73. Plank-dam.....	285
74. Frame Timber Dam.....	286
75. Frame Timber Dam.....	287
76. Canyon Ferry Dam.....	293
77. Poirée Needle-dam.....	303
78. T Needles for Poirée Dam.....	304
79. Needle with Rubber for Poirée Dam.....	304
80. Poirée Needle-dam.....	305
81. Belgian Needle-dam.....	308
82. Boulé Gate.....	314
83. Boulé Gate in Moscow Dams.....	315
84. Caméré Curtain-dam, Front View.....	316
85. Caméré Curtain-dam, Side View.....	317
86. Caméré Curtain-dam, Details.....	317
87. Caméré Curtain-dam, Crab.....	318
88. Caméré Curtain-dam, Cross-section.....	319
89. Location of Poses Dam.....	320
90. Pier of Poses Dam.....	321
91. Location of Suresnes Dam.....	322
92. Thomas A-frame Dam.....	323
93. Thénard Shutter-dam.....	327
94. Chanoine Shutter-dam on the Upper Seine.....	328
95. Chanoine Shutter-dam on the Marne.....	328
96. Chanoine Shutter-dam of Port à L'Anglais Weir.....	329
97. Pasqueau Hurter.....	331
98. Section of Kanawha Dam.....	333
99. Krantz's Pontoon Dam.....	335
100. Krantz's Pontoon Dam.....	335
101. Butterfly Valve.....	335
102. Girard Shutter-dam.....	336
103. Desfontaines Drum-dam.....	338
104. Abutment of Desfontaines Drum-dam.....	339
105. Cuvinot Drum-dam.....	341
106. Chittenden Drum-dam.....	342
107. Bear-trap Gate, Davis Island Dam.....	345
108. Bear-trap Dam on the Marne.....	346
109. DuBois Gate.....	347
110. Carro Gate.....	348
111. Girard Gate.....	348
112. Brunot Gate.....	348
113. Brunot Gate.....	348
114. Parker Gate.....	349

**LIST OF TABLES.**

**xiii**

FIG.	PAGE
115. Lang Gate.....	350
116. Marshall Gate.....	350
117. Joint-rod, for Stoney Gate of Beznau Dam.....	352
118. Link-chains for Stoney Gate of Beznau Dam.....	352
119. Diagram for Calculation of the Length of a Joint.....	404
120. Diagram for Calculation of the Length of a Joint.....	404

---

**LIST OF TABLES.**

---

<b>Table I.</b> De Sazilly's Profile-type.....	388
II. Delocre's Profile-type.....	388
III. Prof. Rankine's Profile-type.....	389
IV. Theoretical Profile on Prof. Rankine's limits and conditions.....	389
V. Krantz's Profile-type.....	390
VI. Prof. Harlacher's Profile-type.....	390
VII. Crugnola's Profile-type.....	391
VIII. Theoretical Profile No. 1.....	391
IX.    "      "      No. 2.....	392
X.    "      "      No. 3.....	392
XI.   "      "      No. 4.....	393
XII.  "      "      No. 5.....	393
XIII. "      "      No. 6.....	394
XIV. Inclined Joints in Theoretical Profile No. 5.....	395
XV. Theoretical Profile No. 5 modified by Bouvier's formulæ.....	395
XVI. Theoretical Type No. I.....	396
XVII. Practical Type No. 1.....	396
XVIII. Theoretical Type No. II.....	397
XIX. Practical Type No. 2.....	397
XX. Practical Profile No. 1.....	398
XXI.  "      "      No. 2.....	398
XXII. "      "      No. 3.....	399
XXIII. Data of Masonry Dams.....	400
XXIV. High Earth Dams.....	401
XXV. Equivalents of the Metric Measures, according to the U. S. Standard.....	402



# DESIGN AND CONSTRUCTION OF MASONRY DAMS.

---

## CHAPTER I.

### INTRODUCTION.

THE remains of ancient works still existing in India and Ceylon bear evidence that the construction of reservoirs for storing water dates from a very remote period of history. The ordinary manner of forming these basins, some of which were of vast extent, consisted in closing a valley by dams of earth; and it was not until comparatively recent times that walls of masonry were employed for such purposes. This method of construction seems to have been first adopted in the southern part of Spain, where, about the sixteenth century, large reservoirs for irrigation were constructed. Much as these early masonry dams excite our admiration by their great dimensions and massiveness, their proportions demonstrate that their designers had no correct conception of the forces to be resisted. By a faulty distribution the great mass of material in some of these walls produces undue strains in the masonry or on the foundation, becoming thus a source of weakness rather than of strength. Prior to the middle of the present century most masonry dams were built according to defective plans. It has been shown, indeed, that some of these walls would have been stronger had their positions been reversed, the down-stream face being turned up-stream.

The French engineers advanced the first rational theory of masonry dams, and proved its correctness by applying it in the construction of some of the highest and boldest reservoir walls of the present time. By means of the great storage basins thus obtained, they control the flow of rivers, retaining the excess of water during the period of flood for the time of drought. The havoc due to inundations may thus be largely prevented, and replaced by all the benefits resulting from irrigation, domestic water supply, and the furnishing of a cheap motive power.

Before entering upon any mathematical details, we will glance briefly at the different steps that have been made in the development of the theory of masonry dams. The first writer who investigated this subject in a satisfactory manner was M. de Sazilly. His memoir on the design of reservoir walls appeared in the "Annales des Ponts et Chaussées" for 1853. According to this writer the safety of a masonry dam depends upon the compliance with the following two conditions:

1st. The pressures sustained by the masonry or its foundation must never exceed a certain safe limit.

2d. There must be no possibility of any portion of the masonry sliding on that below, or of the whole wall moving on the foundation.

To devise a formula containing both of the above conditions of safety would be difficult, if not, indeed, impossible. However, M. de Sazilly states that no masonry dam has been known to fail by sliding, and he therefore recommends that the profile of a dam be designed solely with reference to the first of the conditions, leaving it to a subsequent trial to determine whether the second has been fulfilled. This will generally be found to be the case, especially if the assumed limit of pressure is not very high and the dam has a considerable top-width. Should we find that the wall or part of it might slide, then Sazilly's method would be to increase the thickness of the profile by recalculating it for a lower limit of pressure. This writer pointed out that, in determining the maxima pressures in the masonry or on its foundation, two extreme cases must be considered:

- 1st. When the reservoir is full.
- 2d. When the reservoir is empty.

These two conditions give the extreme positions of the lines of pressure\* in a dam, the first causing the maximum pressure in any horizontal plane to be at the front (down-stream) face of the wall, and the second producing them at the back (up-stream) face. The practical considerations of economy require that a dam should contain the minimum amount of material consistent with safety. Having established a fixed limit of pressure, Sazilly's ideal profile is that in which the maxima pressures in both faces just reach the limit. He called this "the profile of equal resistance." In attempting to find formulæ for determining its form, Sazilly experienced no difficulty in obtaining the correct differential equations, but found it impossible to integrate them, and had therefore to abandon the idea of finding the proper curves for the faces of the "profile of equal resistance." The difficulties of the integration may, however, be avoided by substituting for curved outlines polygonal or stepped faces.

In either case we must assume the dam, for the purposes of calculation, to be divided into courses by horizontal planes. The smaller the depth of these courses, the closer the "profile of equal resistance" will be approached, the approximate types involving always a slight excess of masonry. Against polygonal faces Sazilly urges the following objections:

- 1st. The angles form points of weakness.
- 2d. The gentle slopes of the faces favor vegetation of parasitical plants, which injure the masonry.
- 3d. Such a wall would have a bad appearance and would be difficult to execute.

For the above reasons he recommends as the best practical type a stepped profile, such as shown in Plate I and Table I, for which he gives formulæ.

The next engineer who advanced a method for determining the profile of a masonry dam was M. Delocre. The frequent inundations in the valley of the Loire led the French engineers to plan large reservoirs for retaining the flood-water. Good locations for such works were readily to be found in the upper valleys of the branches of this river, but sufficient storage capacity could only be obtained by constructing dams up to 50 metres (164 ft.) in height. To have formed them of earth would

---

\* The line of pressure (called also line of resistance) is a line intersecting each joint of a structure (whether it be real or imaginary) at the point of application of the resultant of all the forces acting on that joint.



have been extremely hazardous, and walls of masonry were therefore decided upon. M. de Græff, the Chief Engineer of the "Département" in which these reservoirs were to be located, assigned the study of the best type of profile to M. Delocre, and it is upon this engineer's investigations and formulæ that most of the high dams built within recent times have been based. Starting with the same conditions and fundamental formulæ as Sazilly, Delocre arrived at different conclusions. He demonstrated that a stepped profile involved considerable waste of material and required, moreover, an expensive class of masonry for the steps. He argued that the objections raised by Sazilly against polygonal faces would lose their force if only a few changes of slope were employed, and that by adopting such outlines a considerable economy might be effected.

Plate II. and Table II. give the type of profile recommended by Delocre. For sake of comparison he made calculations for two profiles of a dam 50 metres high, one according to Sazilly's method, and the other according to his own, basing them upon a weight of masonry of 125 lbs. per cubic foot, and on a limiting pressure of 6 kilos. per square centimetre (6.15 tons of 2000 lbs. per sq. foot). In Sazilly's type this pressure is only reached at the re-entrant angles of the steps; in Delocre's, only at the vertices of the angles in the faces. The calculations are made for one lineal metre of wall, which is supposed to resist the thrust of the water simply by its weight. Tables I. and II. show that these profiles differ very little from each other as regards stability or resistance to sliding, but the following figures prove that an economy results from adopting Delocre's type:

	Area of profile, in square metres.	Exposed surface for one lineal metre of wall, in square metres.
Sazilly's type, . . . . .	1028.75	152.15
Delocre's type, . . . . .	995.30	119.70
	<hr style="width: 50%; margin: 0 auto;"/>	<hr style="width: 50%; margin: 0 auto;"/>
	33.45	32.45

Delocre has given lengthy formulæ for calculating profiles according to his method, and also investigated the additional strength which might be obtained by building a dam on a horizontal curve in plan. The results of his studies were known in 1858, and formed the basis of the design for the Furens dam near St. Etienne, a reservoir wall 50 metres in height. It was not, however, until after the completion of this work that M. Delocre published in the "Annales des Ponts et Chaussées" for 1866 a memoir giving the details of his researches.

To trace the history of our subject chronologically, we must now turn to an English writer for the next marked advance. In connection with some proposed reservoirs for the city of Bombay, the question arose of deciding Rankine. between the respective merits of earthen and masonry dams. In order to obtain the opinion of a high scientific authority on this subject the question was submitted to Prof. W. J. M. Rankine, who was also requested to make a rigid mathematical investigation of the best form of profile for a masonry dam. The report\* written by Prof. Rankine in response to this request is very complete. His views of the considerations that ought to determine the design for such a dam will readily be accepted. While Rankine recommends that the profile should be determined mainly by the principles

---

\* See Prof. Rankine's "Miscellaneous Scientific Papers," 1881.

laid down by the French engineers, he improves their methods in some respects. Thus these engineers, in calculating the maxima pressures in the masonry, had only considered the vertical component of the resultant pressure of the forces acting at any joint. They therefore assumed the same limit for the intensity of vertical pressure at both faces of the wall. Prof. Rankine says, however: "It appears to me that there are the following reasons for adopting a lower limit at the outer than at the inner face. The direction in which the pressure is exerted amongst the particles close to either face of the masonry is necessarily that of a tangent to that face; and, unless the face is vertical, the pressure found by means of the ordinary formulæ is not the whole pressure, but only its vertical component; and the whole pressure exceeds the vertical pressure in a ratio which becomes the greater, the greater the 'batter,' or deviation of the face from the vertical. The outer face of the wall has a much greater batter than the inner face; therefore, in order that the masonry of the outer face may not be more severely strained when the reservoir is full than that of the inner face when the reservoir is empty, a lower limit must be taken for the intensity of the vertical pressure at the outer face than at the inner face. . . ."

This eminent writer did not attempt to determine the ratio which the limits of the vertical pressure at the front and back face ought to bear to each other, by any mathematical deduction, as he deemed the data upon which it would have to be based too uncertain. In choosing the limits of pressure for the profile accompanying his report (see Plate III. and Table III.) he was guided entirely by what experience had proved to be safe, and adopted:

	Limit of vertical pressure, in pounds per square foot.
For front (down-stream) face, . . . . .	15,625
For back (up-stream) face, . . . . .	20,000

The same reasoning which led Rankine to recommend a lower limit of vertical pressure for the front face than for the back face induced him to make the pressures at the front face diminish as the batter increases. Here, too, he followed practical examples, as he thought it impossible in our present state of knowledge to deduce a law for this diminution. He designed his profile therefore in such manner that the maximum pressure at a depth of 150 feet would equal the pressure at the same depth in the Furens dam; viz.,  $6\frac{1}{2}$  kilos. per square centimetre, or about 6.65 tons of 2000 lbs. per square foot. Below this depth the maxima pressures diminish gradually.

Another principle pointed out by Prof. Rankine is that no tension must be allowed in the masonry. Theoretically this would occur (as will be shown in Chapter II.) whenever the line of pressure lies at any point outside of the centre third of the profile. The stability of the dam against overturning depends upon the position of the line of pressure. For the above reasons Rankine limits these lines (reservoir full or empty) to the centre third of the profile.

The conditions given by Rankine do not prescribe any definite form of profile, but when we add the consideration of economy, requiring the minimum amount of material consistent with safety, the choice of form becomes very limited. The types of Sazilly and Delocre involve very lengthy calculations. Prof. Rankine endeavored to find simpler

formulæ. One of the effects of his using a higher limit of pressure for the back face than for the front is to reduce the batter of the former considerably from that of the French types. The vertical component of the water-pressure on the back of dam can therefore add but little to the stability of the wall. Prof. Rankine neglected this component in his formulæ, as the slight error thus introduced would be in the direction of safety, and also simplifies largely the mathematical investigation.

As regards the profile (Plate III.) accompanying his report, he says: "In choosing a form in order to fulfil the conditions without any practical important excess in the expenditure of material beyond what is necessary, I have been guided by the consideration that a form whose dimensions, sectional area, and centre of gravity under different circumstances are found by short and simple calculations, is to be preferred to one of a more complex kind when their merits in other respects are equal, and I have chosen logarithmic curves for both the inner and outer face, the common subtangent being 80 feet for both."

The formulæ given by Prof. Rankine for determining the thickness, area, etc., of this profile are certainly extremely simple; but then they produce only this one profile, whose dimensions might as well be calculated once for all. Change the data upon which it is based, such as the weight of masonry, limiting pressures, etc., and the simplicity of this method disappears. Rankine states that his general formulæ which we would have to employ in such a case are "incapable of solution by any direct process." They can, however, be solved approximately by a process of trial and error, involving the higher mathematics.

If by means of logarithmic curves a profile differing but little from the exact theoretical type could be obtained, there would be no objections to the use of such approximate methods. Sazilly had demonstrated that a wall sustaining only its own weight would contain the minimum amount of material, consistent with a fixed limit of pressure, by having symmetrical faces, which would be vertical until the limit of pressure were reached, and would then follow logarithmic curves. But similar outlines will not give the best profile for a dam resisting water-pressure, as will be shown in Chapter IV.

In 1856 M. Le Blanc demonstrated, in a study of the stability of arches, that the action of an inclined force  $R$  on a joint did not only produce a compression due to its normal component  $R \cos a$ — $a$  being the angle made by  $R$  with a vertical line—but that, on the contrary, the force to be considered as producing the compression was  $\frac{R}{\cos a}$ .\* The arguments advanced by M. Le Blanc to prove his views did not attract much attention, at the time, and were repeated by him in 1869, but it was not until 1874 that M. Bouvier applied the principles advocated by M. Le Blanc in making calculations of the pressures that would occur in the Ternay Dam, France, if the high-water level of the reservoir were raised 1.65 metres.

Up to that time all writers on the subject of masonry dams, with the exception of Rankine, had calculated the maxima pressures in the masonry by considering only the distribution of the vertical component of the resultant pressure on a horizontal joint.

---

\* M. Bellet's article on masonry dams in *La Houille Blanche* for July 1905.

Rankine, as stated on page 4, made some allowance for the pressures produced by the inclined resultant in the case of reservoir full by adopting a lower limit of safe vertical pressure for the down-stream than for the up-stream face of the dam.

M. Bouvier\* proposed to calculate the pressures of the whole resultant pressure at any joint by considering the joint to be projected at right angles to the line of action of the resultant. The details of his method will be explained in the following chapter. The maxima pressures found by Bouvier's formulæ are always greater than those obtained by the older methods, and, if the same limits of pressure be adopted, a profile found by the older methods must be increased in width to satisfy the formulæ of Bouvier.

Another analytical method of calculating the profile of a masonry dam was advanced by M. Pelletreau in the "Annales des Ponts et Chaussées" for 1876, 1877, and 1879. This writer adopted the same basis as Sazilly and Delocre, placing no limits to the positions of the lines of pressure. By an intricate investigation involving the higher mathematics he found a simple series which expresses the thickness of a dam at any depth, so long as the back face remains vertical; but for the case when both faces must be battered he did not succeed in finding a general formula. A later memoir by Pelletreau on the subject of masonry dams is published in the "Annales des Ponts et Chaussées" for 1897.

M de Beauve has given in his "Manuel de L'Ingénieur des Ponts et Chaussées" a graphic method of finding the profile of a dam, based upon Sazilly's and Delocre's conditions, which is accurate but laborious.

Empirical formulæ for determining the profile of a masonry dam have been devised by Molesworth (see his Pocket-book of Engineering Formulæ) and by others. A method consisting partly of equations and partly of trial calculations is given by W. B. Coventry in his memoir on "The Design and Stability of Masonry Dams" in Proceedings of the Institute of Civil Engineers (1885-86).

Prof. A. R. Harlacher of Prague, in a report on a proposed dam near Komatau (Bohemia), written in 1875, recommends trial calculations as the best practical method of finding the correct profile for a masonry dam. In this manner he designed the profile given in Plate VI and Table VI.

M. Krantz † and M. Crugnola ‡ have published profile types for dams of various heights which were probably found by trial. Neither of these engineers gives any formulæ for this purpose. The types they proposed for a dam 50 metres (164 feet) high are shown, respectively, in Plate V and Table V, and in Plate VII and Table VII.

Prof. Franz Kreuter has given some formulæ for calculating the profile of a masonry dam in the Proceedings of the Institute of Civil Engineers for 1893-94. While they make the profile sufficiently strong, they do not produce the section of minimum area, satisfying the given conditions.

M. Guillemain advocated, in his work "Rivières et Canaux" in "L'Encyclopédie des Travaux publics" a new method of determining profiles of masonry dams, based upon the consideration of oblique joints. His method is as follows:

Let Fig. 1 represent a profile determined by the methods of Sazilly, Delocre, or Rankine. If, instead of calculating the distribution of the vertical component of the resultant

\* Bouvier's Memoir in the "Annales des Ponts et Chaussées" for 1875.

† Etude sur les murs de réservoir. Paris, 1870.

‡ Muri di Sostegno e Traverse dei Serbatoi d'Acqua. Torino, 1882.

of the water pressure to the depth  $N$  and of the weight of the masonry upon the horizontal joint  $NM$ , we find the distribution of pressure on the inclined joint  $MS$ , taking into consideration the full depth of the water to  $S$ , we shall find a greater pressure at  $M$ . This pressure may even exceed the pressure at the down-stream toe  $T$ . If the pressure found at  $M$ , by considering the inclined joint  $SM$ , be greater than the adopted limit of safety, the profile must be increased in width at this point sufficiently to keep the maximum pressure on the joint within the fixed limit. Guillemain's method consists in calculating

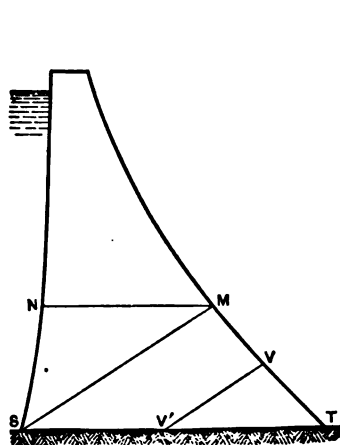


FIG. 1.

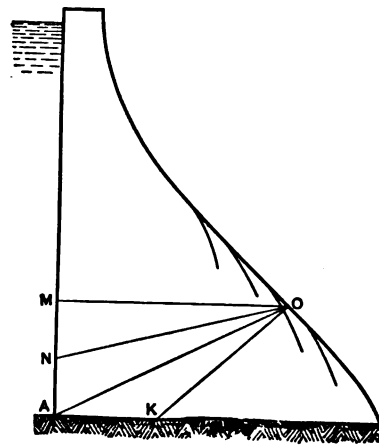


FIG. 2

pressures on inclined joints radiating from a point  $O$  (Fig. 2) at the front face of the dam and increasing the width of the profile so as to keep the maximum pressure found in this manner within the adopted limits of safety. The profile based upon this condition is to be found by trial.

M. Hétier, in a study of retaining-walls, including masonry dams,\* comes to the same conclusion as Guillemain, that a dam should have a greater section toward its base than that given by the method of Sazilly, Delocre, etc. Taking in Fig. 3 the down-stream face as being given by a straight line from  $M$  to the base, Hétier investigates different inclined joints revolving about a point  $Cn$  on the up-stream face, and finds expressions for the maximum and minimum pressures produced at the down-stream side. If the maximum pressure exceeds the adopted limit the width of the profile must be increased. The profile resulting from this method is somewhat like the profile found by Guillemain.

M. Clavenad, who was the secretary of the Commission appointed to investigate the causes of the failure of the Habra Dam in Algiers, q.v., came to the conclusion that the failure was due to shearing in an inclined direction.† Guillemain and Hétier advocated making calculations for inclined joints in a dam. Clavenad recommended that the resistance of the dam to shearing be also calculated for inclined joints. This method is as follows:

In Fig. 4 let  $MA$  represent in magnitude and direction the resultant force applied to a dam  $ABCD$  and let  $AN$  represent the weight of the triangle  $ABE$ ,  $AE$  being any

\* M. Hétier's memoir in "Annales des Ponts et Chaussées" for 1885.

† M. Clavenad's memoir in "Annales des Ponts et Chaussées" for 1887.

assumed inclined joint. Draw  $NP$  perpendicular to  $AE$ , and  $MP$  parallel to  $AE$ . The length  $NP$  will represent the normal component of the pressures on  $AE$ , and  $MP$  will represent the tangential component.

If from the point  $N$  we draw the line  $NK$ , making with the normal line  $NP$  the angle of friction for masonry on masonry, which we will denote by  $f$ , the length  $KP$  will

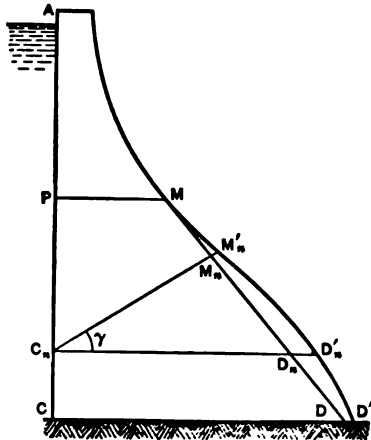


FIG. 3.

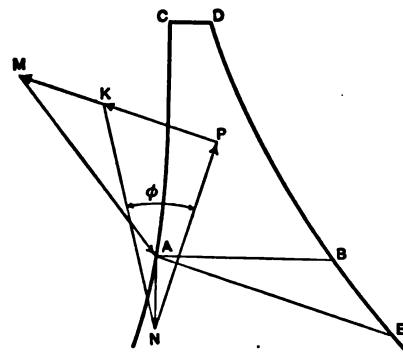


FIG. 4.

represent the resistance to sliding, due solely to friction, and  $MK$  will represent the shearing strain to which the masonry is exposed. This should be ascertained for different inclinations of joints radiating from  $A$ . If the greatest shear found in this manner should exceed the resistance masonry can safely oppose to shearing the dam would evidently fail by shearing and should be given a large profile.

The most recent and best French method of determining the profile of a masonry dam is due to M. Maurice Levy. We cannot give this method in detail here and must refer the reader to Levy's Memoirs in "L'Academie des Sciences," August 5, 1895, and in the "Annales des Ponts et Chaussées" for 1897.

In a paper on "Some Disregarded Points in the Stability of Masonry Dams,"\* L. W. Atcherley, Demonstrator of Applied Mechanics, University College, London, who received some assistance in this matter from Prof. Karl Pearson, F.R.S., University College, London, points out some defects in the accepted methods of designing the profiles of masonry dams. He states:

"We see no reason whatever why dams should be tested solely by taking horizontal cross-sections, and asserting that the line of resistance must lie in the horizontal middle third, and absolutely neglecting the stresses across the vertical sections of the tail. We consider that if the former condition is valid, then no dam ought to be passed unless it can be shown that there is no tension of any serious value across the vertical cross-sections of the tail. We believe that a great number of dams, as now designed, will be found to have very substantial tension in the tail, and this is, in our opinion, a source of weakness in dam construction which has not been properly considered and allowed for."

By "tail" in the above Atcherley refers to that part of the dam which is generally

\* Published in "Draper's Company Research Memoirs," Technical Series II, London, 1904.

designated by American engineers as the "down-stream toe." Bouvier, Guillemain, etc., recommended that the strength of a dam be not only tested for horizontal joints but also for inclined joints. Atcherley goes one step farther and advises that vertical joints be also assumed and tested. As a result of his studies and of experiments made with models of dams (Fig. 5) he reached the conclusion that a dam will be found to be weaker, if tested for vertical joints, instead of horizontal joints, and that large tensions will be found to exist across the vertical sections.

Atcherley tested his conclusions by experiments made with two wooden models of dams, one being divided into horizontal strata and the other into vertical strata (Fig. 5).

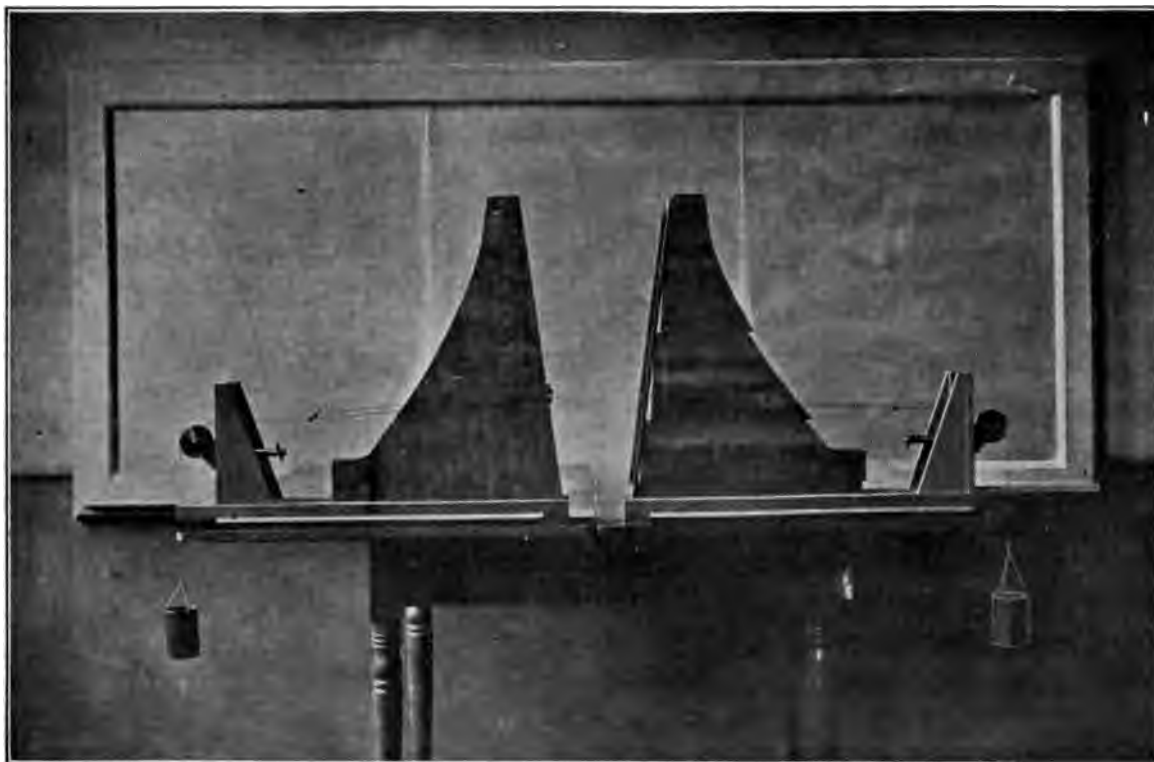


FIG. 5.—ATCHERLEY'S MODELS OF DAMS.

The pull representing the water pressure was produced by a cord which passed over a vertical pulley and terminated in a bucket into which shot was gradually dropped. In the case of the model divided into horizontal strata, the pull of the cord was communicated to a stiff lath, which bore on the ends of the horizontal strata through two longitudinal strips of India-rubber tubing.

The angle of friction for the wooden strips, which had been left almost rough sawn to increase the friction, varied from about 25 to 30 degrees, while for masonry on masonry this angle is usually assumed at 30-36 degrees. Different expedients were resorted to to increase the friction between the strips of wood.

As regards the main features of the numerous experiments made, Atcherley states:

"The horizontally stratified dam either sheared at its base or just above the tail between the third and fourth strata; in either case the giving way at one or other of these sections was the signal for an approaching general collapse. The vertically stratified

dam opened up by tension very close to the tail and then sheared over. It had to be watched very closely to follow the sequence of events, as the collapse was far more immediate and sudden than in the case of the horizontally stratified dam. The nature of the rupture could be better exhibited by pasting the last two or three blocks together with tissue paper and then the dam invariably opened up by tension at the next section and showed this opening up in a marked manner."

The conclusions drawn by Atcherley from these experiments are:

"1. The current idea that the critical sections of a dam are the horizontal sections is entirely erroneous. A dam collapses first by the tension on the vertical sections of the toe.

"2. The shearing of the vertical sections over each other follows immediately on this opening up by tension.

"3. It is probable that the shear on the horizontal sections is also a far more important matter than is usually supposed.

"It follows from this that getting the line of resistance into the middle third of the horizontal sections, upon which all energy seems at present to be concentrated, is by no means the hardest and stiffest part of dam design. We should be much surprised if, with all the labor spent on this point, the bulk of existing dam constructions are not for masonry under very considerable tension, i.e., a tension across the vertical sections, which has been hitherto disregarded.

"We propose therefore to lay it down as a rule for the construction of future dams that the stability of the dam from the standpoint of the vertical sections must be considered in the *first* place. If this be satisfactory, we believe that the horizontal sections will be found to be stable, but of course the latter must be independently investigated."

In the preceding pages we have traced the development of the theory upon which the profile of a masonry dam should be based. The principles upon which the stability of a masonry dam is usually considered to depend are very simple, but the mathematics to which they give rise, when applied to the design of a profile, are exceedingly complicated. The formulæ devised for this purpose are so unsatisfactory that some engineers prefer to find a proper profile for a dam by means of trial calculations.

While a correct profile for a masonry dam may doubtless be found by a sufficient number of trials, such a method is very laborious and unsatisfactory. Impossible as it may be to determine at once the proper outlines for a profile which shall contain the minimum area consistent with the given conditions, there are no great mathematical difficulties involved in calculating its thickness at intervals, commencing at the top. To obtain the minimum area these intervals should be infinitely small. For practical purposes we can find a profile which shall approach the true theoretical type as closely as may be desired, by making the intervals at which the calculations are made sufficiently small.

The profile resulting from this method will have polygonal outlines, involving many changes of slope. As it fulfils all the given conditions and contains, at the same time, practically the minimum area consistent therewith, we shall call it *the Theoretical Profile*. It might serve as a design for a dam, were it not for constructive objections to the many changes of batter in the faces. To obtain a profile which can be readily



executed and also offers a pleasing effect, we have only to fit a few simple curves or straight lines to the theoretical form, reaching thus *a Practical Profile*. Small changes made for this purpose will have but a trifling effect upon the stability of the dam; and while the practical profile may not satisfy the given conditions rigidly, it will certainly do so practically.

The methods proposed by the eminent engineers already mentioned give but approximations to the correct theoretical form. Closer results may be obtained by following the method we have just explained. The equations we shall give for this purpose are exceedingly simple, being all quadratic with the exception of one of the third degree, which will seldom be used. The profile for the proposed Quaker Bridge Dam (see Plate LXXVIII.) was determined in this manner.

Before explaining our method in full, we will first examine in the next chapter the fundamental formulæ used by all writers for determining the distribution of stress in a wall of masonry.

## CHAPTER II.

## DISTRIBUTION OF PRESSURE IN A WALL OF MASONRY.

SCIENCE has not yet revealed the laws which the internal stresses in a mass of masonry follow. We are therefore obliged, in treating of masonry dams, to resort to some safe hypothesis which shall furnish results approximately correct. All mathematical formulæ for masonry dams have thus far been established by considering these walls as rigid and composed of homogeneous masonry. This hypothesis involves two inaccuracies, as masonry is always more or less elastic, and seldom perfectly homogeneous. We shall show in this chapter that by assuming a dam to be rigid we exaggerate, in all probability, the pressures in the weakest part of the wall, namely, near the faces,—and make thus an error in the direction of safety. By careful inspection during construction we may obtain masonry which shall be practically homogeneous. The above hypothesis may therefore be safely accepted, and we shall in future consider masonry dams as forming rigid homogeneous monoliths.

Another assumption which is generally made is that a dam will resist the thrust of the water simply by its own weight. It follows from this that in studying the conditions of equilibrium of such a wall (every part of which is supposed to be built according to the same profile) we need only consider a section one foot long.

For the present investigations we will assume a dam built according to some ordinary type, having sloping faces and a rectangular base, resting on a horizontal foundation. Whether the reservoir be empty, partially or totally filled, the given section of wall will be acted upon by symmetrical forces. Their resultant must lie in a vertical plane, perpendicular to the faces of the wall, and bisecting the given section. When the reservoir is empty the resultant will be the total weight of the wall acting vertically through its centre of gravity. We will confine ourselves first to this case and investigate the laws of distribution of the pressure on the base of the wall. Let us suppose the dam to be rigid and built upon a perfectly elastic foundation.

When the resultant pressure passes through the centre of gravity of the base (which in the given case is also its geometrical centre) the pressure will be uniformly distributed over the foundation, by compressing which the dam will settle evenly, its base remaining horizontal. When, however, the resultant pressure does not pass through the centre of gravity of the base, it will no longer be uniformly distributed on the foundation. The eccentric resultant by throwing more pressure on one edge of the base than on the other will cause unequal settling and therefore tilt the dam. Owing to the rigidity of the wall and the elasticity of the foundation, the pressures on the latter will now follow the laws of a uniformly varying stress, and may be represented by the ordinates between a horizontal and an inclined line.

The reaction of the foundation from face to face of wall may be shown graphically by a plane figure, whose area will represent the total pressure, whose centre of gravity will lie

in the line of action of the resultant pressure, and whose vertical ordinate at any point will give the corresponding intensity of stress. A uniformly distributed pressure would be represented graphically by a rectangle as in Fig. 6. A uniformly varying pressure will be shown graphically by a trapezoid or triangle, depending upon the position of the result-

FIG. 6.

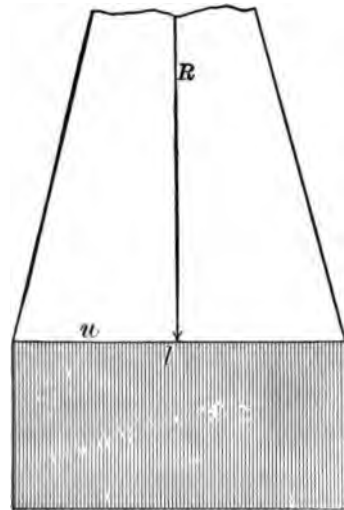
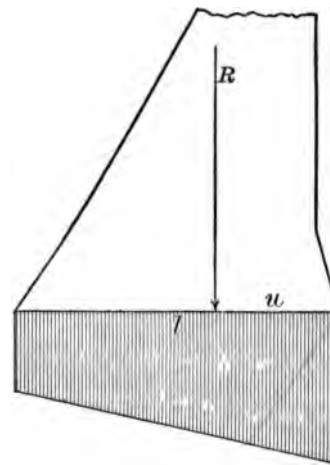


FIG. 7.



ant pressure, which must pass through the centre of gravity of the figure, viz.: When the eccentricity of the resultant is less than one sixth the width of the base, the reaction of the foundation will be shown by a trapezoid, Fig. 7. Should this eccentricity just equal one sixth the width of the base, the trapezoid would become a triangle, Fig. 8. When the resultant is still nearer to one edge, the dam will be tilted so much that part of the base

FIG. 8.

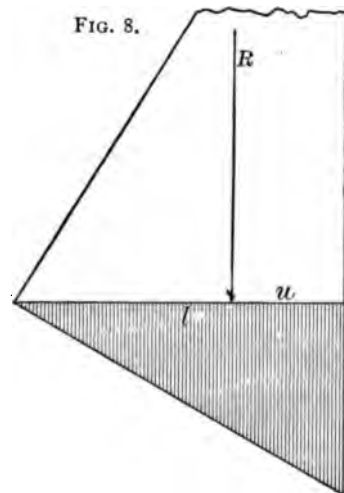
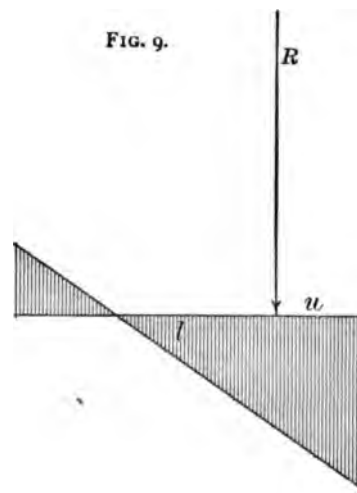


FIG. 9.



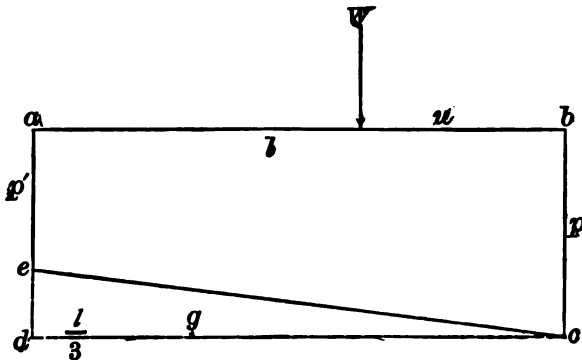
will have to bear the whole pressure, the remaining portion being raised entirely from the ground. The reaction in this case will also be represented by a triangle as in Fig. 9. Should the adhesion between the foundation and the base prevent the latter from being partially raised from the ground, then part of the base will have to sustain tension. This will modify the distribution of the pressure, which, however, will still form a uni-

formly varying stress. To illustrate the above laws, imagine a rigid plank floating in water and bearing a movable load. As this latter is shifted from the centre towards either end, each of the above cases will arise, the water-pressure under the plank representing the reaction of the foundation.

We have thus far considered the foundation as elastic, but will now suppose it to be rigid. It can no longer be compressed by the weight of the dam; but as the tendency to cause compression remains the same whether the foundation be rigid or elastic, it is rational to assume the same distribution of pressure for both cases.

The laws of distribution of pressure, given above, were first indicated by M. Méry in his memoir on the stability of arches, and were perfected by M. Bélanger in the course of Applied Mechanics taught by him at the École des Ponts et Chaussées.\* The formulæ resulting from these laws may be derived in many different ways. The following solution will be found to give the usual formulæ by a short method. Both the dam and the foundation are assumed as rigid.

FIG. 10.



Let  $W$  = the total pressure on the base  $ab$ ;

$u$  = the distance of  $W$  from the nearer edge  $b$ ;

$p$  = the maximum intensity of pressure on the foundation;

$p'$  = the minimum intensity of pressure on the foundation;

$l$  = the width of the base  $ab$ ;

$g$  = the centre of gravity of triangle  $ced$ .

First let  $u > \frac{l}{3}$ .

$$\begin{aligned} \text{Trapezoid } abce &= \text{the reaction of the foundation} \\ &= abcd - ecd \\ &= pl - \frac{l}{2}(p - p'). \end{aligned}$$

As  $W$  and the reaction of the foundation are in equilibrium, the algebraic sum of their moments about any point must be zero.

Taking moments about the point  $g$ , we find, since the moment of the triangle  $cde$  is 0,

$$\frac{l^2 p}{6} - W \left( \frac{2}{3}l - u \right) = 0;$$

whence

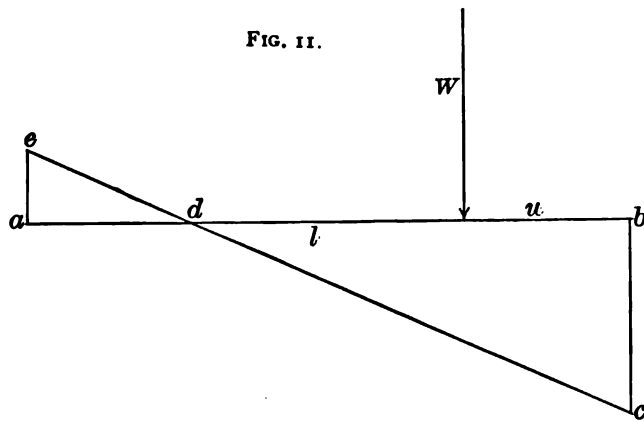
$$p = \frac{2W}{l} \left( 2 - \frac{3u}{l} \right). \dots \dots \dots (A)$$

When  $u = \frac{l}{3}$ , the trapezoid of reaction becomes a triangle, and we have

$$p = \frac{2W}{l}. \dots \dots \dots (B)$$

\* M. Sazilly's memoir on reservoir walls in the "Annales des Ponts et Chaussées" for 1853.

When  $u < \frac{l}{3}$  we should have, according to the laws of a uniformly varying stress, a positive and a negative triangle, the former representing the pressure on the foundation, the latter the tension on the base. As



it would, however, be unsafe to depend upon the tension in the masonry, it is best to neglect it in calculating the pressure on the foundation. Fig. 6 shows this case.

Neglecting the tension  $adc$ , and taking moments about  $b$ , we obtain

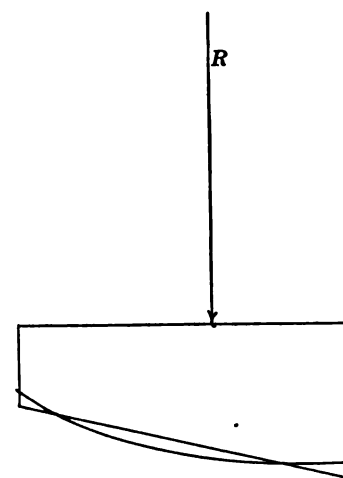
$$Wu - \frac{3pu^2}{2} = 0;$$

hence  $p = \frac{2W}{3u}$ . . . . . (C)

Formulae A, B and C are correct for a rigid dam resting upon a rigid or elastic foundation. But now let us suppose the masonry itself to be elastic. We have no exact knowledge of the manner in which pressures would be distributed in such a body. However, in the practical cases with which we have to deal we can indicate how the formulae A, B and C would have to be modified. Unless the height of a dam be very insignificant, one or both faces will be sloped or stepped. The compression of the masonry at the base of a dam, resulting from its own weight, will depend mainly upon the column of masonry directly over any given part. The central portions of the base will, therefore, be compressed more than those near the edges, and consequently the diagrams of

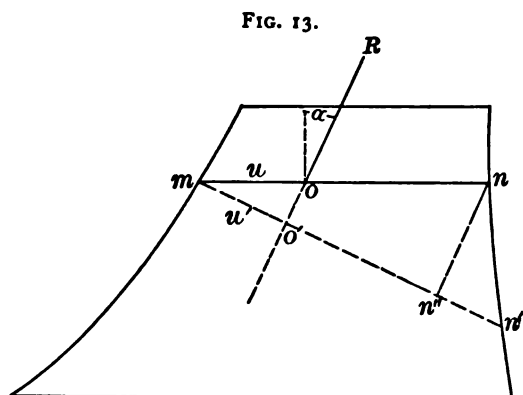
the reaction of the foundation will be modified somewhat as shown in Fig. 12 by the curved line. The pressures near the edges of the base will be less and in the other parts greater than those calculated for a rigid dam. We certainly cannot conceive of the opposite to this taking place. Now, the central portions of the masonry, owing to the lateral support they receive, can bear safely much greater pressures than the masonry at the faces. Thus, we conclude that the inaccuracies involved in using formulae A, B and C will be on the safe side. These formulae may evidently be applied in finding the pressures in the masonry at any given plane; for we may consider the part of the wall above the plane as forming the dam proper, and the lower part as the foundation.

FIG. 12.



Thus far we have only considered the distribution of a vertical resultant on a horizontal plane. When, however, the resultant is inclined (as will always be the case when the reservoir is filled) it can be resolved into two components, one parallel with and the other normal to the given plane. The former will be opposed by the resistance of the dam to sliding or shearing. The latter will be distributed in accordance with formulae A, B or C. This method of calculating the pressures in the masonry at any horizontal joint has

been adopted by most of the early writers on the subject of dams. But, although the results obtained are correct as regards the distribution of the normal pressure, this method does not determine the maxima pressures to which the masonry is subjected. As already stated in Chapter I., Prof. Rankine argues that the pressures near the faces of the wall will be tangential to them, and that therefore, in considering the pressures normal to a given horizontal joint, we have only taken part and not the whole pressure.



As he thought it impossible to find the real maxima pressures by any theoretical means, he advised the use of the old method of resolving the resultant pressure into a normal and parallel component; but adopted different limits of pressure for the front and back face of the wall, on account of the difference in their batters.

The French engineer M. Bouvier claimed that the maxima pressures would depend upon the inclination of the resultant, and therefore modified the formulæ already given as follows:\*

- Let  $R$  = the resultant pressure on an imaginary joint  $mn$ ;
- $\alpha$  = the angle of inclination of  $R$  from a vertical line;
- $l$  = length of joint  $mn$ ;
- $l'$  = length of joint  $mn'$ , which is perpendicular to the direction of  $R$ ;
- $u = mo$ ;
- $u' = mo'$ .

M. Bouvier considers the pressure of  $R$  to be distributed in the following manner on the joint  $mn'$  to which it is normal: He neglects the weight of triangle  $mn'n''$ , and considers it simply as transmitting the pressure of  $R$  to  $mn'$ . He also assumes that no pressure will pass through the triangle  $mn'n''$ . The whole pressure of  $R$  will, therefore, be distributed on  $mn'$  in accordance with the laws embodied in formulæ A, B and C. We must, however, substitute

- for  $l$ , . . . . .  $l \cos \alpha = mn'$ ;
- for  $u$ , . . . . .  $u \cos \alpha$ ;
- for  $W$ , . . . . .  $R$ .

The resulting formulæ will be:

$$p' = 2 \left( 2 - \frac{3u}{l} \right) \frac{R}{l \cos \alpha}; \quad \dots \dots \dots A'$$

$$p' = \frac{2R}{l \cos \alpha}; \quad \dots \dots \dots B'$$

$$p' = \frac{2R}{3u \cos \alpha}. \quad \dots \dots \dots C'$$

The pressures obtained by formulæ  $A'$ ,  $B'$  and  $C'$  are evidently always in excess of those derived by A, B and C. M. Bouvier states that M. Blanc arrived at the same

\* 'Calculs de résistance des grands barrages en maçonnerie.' Annales des Ponts et Chaussées, Aug. 1875.

conclusions from a more general discussion of the subject (see memoir No. 242 in the "Annales des Ponts et Chaussées" for 1869).

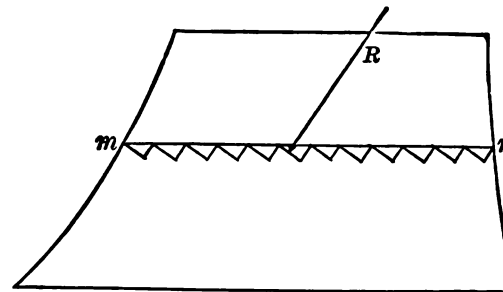
The writer is also informed that M. Guillemain in his lectures at the *École des Ponts et Chaussées* derives  $A'$ ,  $B'$  and  $C'$  by considering only the projections normal to  $R$  of the portions of the joint  $mn$  as shown in Fig. 14.

All mathematical methods of designing dams are based upon a distribution of pressure according to the laws explained in this chapter. Great caution must be used, however, in apply-

ing the formulæ given to cases where the resultant pressure is sufficiently eccentric to produce tension. In a well-designed dam this condition ought never to exist. Where part of the masonry is under pressure and part in tension, there will be great uncertainty in determining the distribution of the stresses. The usual method in such cases has been to neglect the tension and to use formula C for finding the pressure.

In the method of designing profiles which will be given in the next chapter, we shall limit the position of the lines of pressure to the centre third of the profile, avoiding thus all tension and calculating the maxima pressures by formula A or B.

FIG. 14.



## CHAPTER III.

## THEORETICAL PROFILES.

IN the following investigations—

“Front” will signify “down-stream.”

“Back” will signify “up-stream.”

$P$  will denote the line of pressure, reservoir full.

$P'$  will denote the line of pressure, reservoir empty.

The unit of weight will be one cubic foot of masonry.

All linear dimensions will be expressed in feet.

$a$  = the top width of the dam.

$x$  = the unknown length of a joint of masonry.

$l$  = the known length of the joint above  $x$ .

$h$  = the depth of a course of masonry (assumed generally = 10 feet).

$u$  = the distance of  $P$  from the front edge of the joint  $x$ .

$n$  = the distance of  $P'$  from the back edge of the joint  $x$ .

$m$  = the distance of  $P'$  from the back edge of the joint  $l$ .

$v$  = the distance between  $P$  and  $P'$  at the joint  $x$ .

$f$  = the coefficient of friction for masonry on masonry.

$c$  = the cohesion of the masonry per square unit.

$r$  = the specific gravity of the masonry.

$d$  = the depth of water at a given joint  $x$ .

$H = \frac{d^2}{2r}$  = the horizontal thrust of the water.

$M = \frac{d^3}{6r}$  = the moment of  $H$  about any point in the joint  $x$ .

$W$  = the total weight of masonry resting on the joint  $x$ .

$w$  = the total weight of masonry resting on the joint  $l$ .

$R$  = the resultant of  $H$  and  $W$ .

$R'$  = the resultant of the reactions.

$\alpha$  = the angle made by  $R$  with a vertical line.

$p$  = the limiting pressure per square foot at the front face of the dam.

$q$  = the limiting pressure per square foot at the back face of the dam.

$q > p$  will be generally assumed.

There are four ways in which a dam may fail:

1st. By overturning.

2d. By crushing.

3d. By sliding or shearing.

4th. By rupture from tension.



To insure ample safety against all these causes of failure, we shall require the profiles which are to be determined to comply with the following conditions:

1st. The lines of pressure must lie within the centre third of the profile, whether the reservoir be full or empty.

2d. The maxima pressures in the masonry or on the foundations must never exceed certain fixed limits.

3d. The friction between the dam and its foundation, or between any two parts into which the dam may be divided by a horizontal plane, must be sufficient to prevent sliding.

The first of the above conditions precludes the possibility of tension, and insures also a factor of safety of at least 2 against overturning, as will be seen from the following:

Suppose the lines of the reaction  $R'$  and of  $W$  to intersect the joint  $l$  at the limits of its centre third, as shown in Fig. 10. Taking the moments of the forces  $R'$ ,  $W$  and  $H$ , which are in equilibrium, about the point  $e$ , we find

$$\frac{Hd}{3} = \frac{Wl}{3}.$$

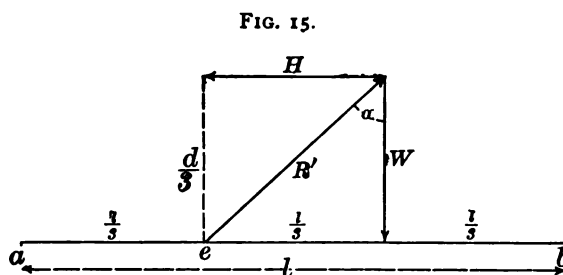


FIG. 15.

If the moments are taken about the front edge  $a$ , the lever-arm of  $W$  will be doubled, while that of  $H$  remains unchanged. The factor of safety against overturning is therefore 2. It is evident that if the line of action of  $W$  or  $R$ , or both of them, should intersect  $l$  within its centre third, the factor of safety against overturning, called factor of stability, would be greater than 2.

The resistance of a dam to sliding has generally been calculated in the following manner:

If we conceive the wall to be cut by a horizontal plane at a given joint  $l$ , there will be two forces which will prevent the upper part from sliding on the lower one:

1st. The cohesion of the masonry.

2d. Friction.

We must have for equilibrium

$$H \leq fW + cl. \quad \dots \dots \dots (D)$$

The value of  $c$  is considerable for good masonry, but cannot be accurately determined. If we consider  $cl$  as a margin of safety, and place

$$H \leq fW, \quad \dots \dots \dots (E)$$

ample security against sliding will be insured. These formulæ may also be applied to the base of the dam, in which case  $c$  = the adhesion of the base to its foundation and the resistance due to the irregularities of the latter.

The value of  $f$  has been taken by different writers from .67 to .75. To find in any given case what value of  $f$  would prevent sliding, we have, from (E) and Fig. 10,

$$f = \frac{H}{W} = \tan \alpha. \quad \dots \dots \dots (F)$$

The maxima pressures in the masonry or on its foundation are to be determined by formula A, B or C. In applying these, however, we have followed Prof. Rankine's method of neglecting the vertical component of the water-pressure. As the early French writers adopted very low limits of pressure (6 kilos. per square centimetre), the up-stream sides of the profiles which they designed had considerable slope. The vertical component of the water-pressure became thus an important factor, which had to be considered in the calculations. Experience has since demonstrated that much higher limits of pressure may be safely adopted, especially for the up-stream side, which, under these circumstances, becomes very steep. By neglecting now the vertical component of the water-pressure, when the back face is nearly vertical, only a trifling error in the direction of safety will be made, as the force which has been omitted adds to the stability of the dam, and diminishes slightly the pressures at the front face by moving  $P$  up-stream. There are several additional reasons for adopting this course, which will be explained in Chapter IV., page 30.

It is impossible to express the thickness of a dam at a given joint by a formula which will satisfy at once the three conditions given on page 19. However, it will always be found within the limits of practice that by satisfying the first two of them we have also fulfilled the third. The reason of this fact will be explained in Chapter V. We shall base the thickness of a dam, therefore, upon the first two general conditions.

In establishing the necessary equations, we shall consider only one lineal foot of a dam, and suppose it to resist the thrust of the water simply by its own weight. Although we shall imagine this section of a dam to form a rigid monolith of homogeneous masonry, we will assume it for the purposes of calculation to be divided into courses by horizontal planes.

The profiles will be proportioned simply with reference to the hydrostatic pressure of the water, the highest elevation of its surface being taken at the level of the top of the dam. Theoretically, this would allow us to make the top width of the wall equal to zero. However, to resist the action of waves, the shocks from floating bodies, and to serve as a means of communication, a dam must always have more or less top width, which will be determined solely by special considerations, depending upon the locality, etc.

To obtain a profile containing the least area which will fulfil the requirements, we shall calculate the joints to be just on the given limits.

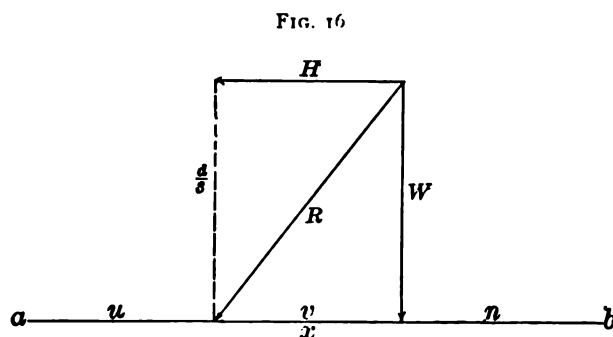
With the conditions advanced in this chapter, a given joint of masonry will always be composed of three parts, as shown in Fig. 16. We can write, therefore,

$$x = u + v + n; \dots (I)$$

but 
$$H \frac{d}{3} = M = Wv,$$

since  $R$  is the resultant of  $H$  and  $W$ .

Hence 
$$v = \frac{M}{W}. \dots (G)$$



As we shall adopt polygonal outlines for the *theoretical profile*, each course of

masonry will have a trapezoidal cross-section, and we will have, recollecting that the unit of weight is one cubic foot of masonry,

$$W = w + \left(\frac{l+x}{2}\right)h. \dots \dots \dots \text{(H)}$$

Therefore

$$v = \frac{M}{w + \left(\frac{l+x}{2}\right)h}, \dots \dots \dots \text{(I)}$$

which value being substituted in Equation (I) gives

$$x = u + \frac{M}{w + \left(\frac{l+x}{2}\right)h} + n. \dots \dots \dots \text{(II)}$$

By substituting for  $u$  and  $n$  their proper values, which result from the conditions imposed, we can determine by means of Equation (II) the exact theoretical thickness of a dam at intervals, taken as small as may be desired.

In the upper portions of the profile, where the pressure in the masonry is inconsiderable,  $u$  and  $n$  will be determined solely by the 1st condition, according to which  $u = \frac{x}{3}$  and  $n = \frac{x}{3}$ . When, however, the pressures in the masonry reach the limits  $p$  and  $q$ , the maxima pressures at the joints to be calculated must be kept on these limits by substituting values for  $u$  and  $n$  derived from formula A (page 14), viz.:

$$u = \frac{2x}{3} - \frac{px^2}{6W}, \dots \dots \text{(J)}$$

$$n = \frac{2x}{3} - \frac{qx^2}{6W}, \dots \dots \text{(K)}$$

in which

$$W = w + \left(\frac{l+x}{2}\right)h. \dots \dots \text{(H)}$$

As we shall commence the design of a dam with a given top width, determined by special considerations, the upper portions of the profile will necessarily have an excess of material as regards resistance to the hydrostatic pressure of the water. To obtain the minimum area of profile, both faces must be continued vertical until one of the limiting conditions is reached. Overhanging faces would give a smaller profile, but should not be adopted for obvious reasons.

The upper portion of the profile ought, therefore, to be a rectangle.  $P'$  will pass through its centre, but, owing to the water-pressure,  $P$  will gradually approach the front face, reaching eventually a joint  $x = a$ , where  $u = \frac{a}{3}$ .

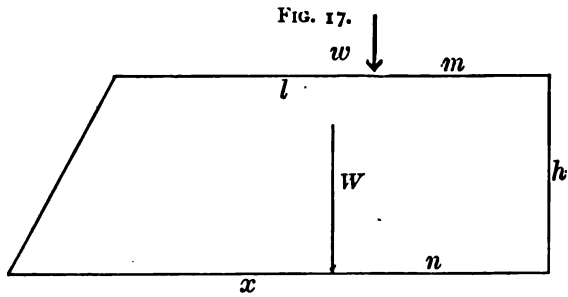
To find the depth of this joint below the top of a dam, substitute in Equation (II)

$$x = l = a, \quad u = \frac{a}{3}, \quad n = \frac{a}{2}, \quad h = d, \quad w = 0.$$

By reducing, we obtain

$$d = a\sqrt{r}. \dots \dots \dots \text{(I)}$$

✓ The front face must now be sloped to keep  $P$  on the limit of the centre third of the profile; but, as  $P$  is in the centre of the joint just found, the back face may be continued vertical for a series of courses. Fig. 17 shows the cross-section of one of them.

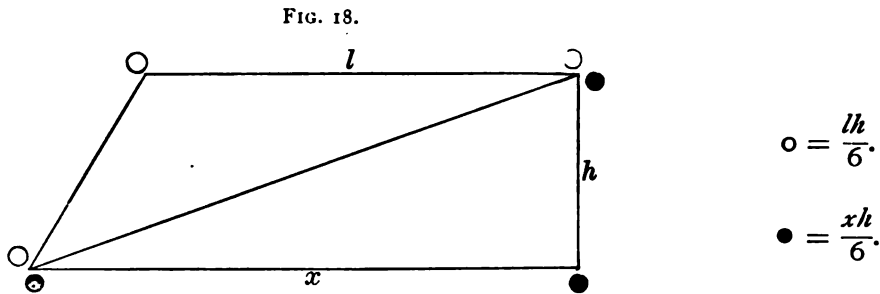


We shall again employ Equation (II) to find  $x$ , placing  $u = \frac{x}{3}$ . As  $P$  will lie within the centre third of  $x$ ,  $n$  will not be determined by the limiting conditions, but can be found by taking moments about the back edge of the course.

The moment of  $W = Wn$ .

The moment of  $w = wm$ .

To find the moment of the trapezoid  $(\frac{x+l}{2})h$ , divide it into two triangles, as shown in Fig. 18.



As the centre of gravity of a triangle equals the centre of gravity of three equal weights placed at its apices, we may substitute for the trapezoid 6 weights, as shown in the figure. We will find

$$\text{moment of } (\frac{x+l}{2})h = (x^2 + lx + l^2)\frac{h}{6}.$$

The moment of the whole weight must equal the moments of its parts; therefore

$$Wn = wm + (x^2 + lx + l^2)\frac{h}{6};$$

whence, placing 
$$W = w + (\frac{x+l}{2})h, \dots \dots \dots (H)$$

we obtain 
$$n = \frac{(x^2 + lx + l^2)\frac{h}{6} + wm}{w + (\frac{x+l}{2})h}.$$

Substituting this value and also  $u = \frac{x}{3}$  in Equation (II), we find, after reducing,

$$x^3 + (\frac{4w}{h} + l)x = \frac{6}{h}(wm + M) + l^3. \dots \dots \dots (2)$$

Equation (2) may be used for a series of joints, until one is found where  $n = \frac{x}{3}$ .

For the next course both faces will have to be sloped so that  $u = n = \frac{x}{3}$ .  
 Substituting these values in Equation (II), and reducing, we obtain

$$x^3 + x\left(\frac{2w}{h} + l\right) = \frac{6M}{h} \dots \dots \dots (3)$$

Thus far we have only been obliged to introduce the first general condition (page 15) into our formulae, as the pressures in the upper portions of the profile do not reach the limit. However, in applying Equation (3) to a series of joints, we must always, after finding a value for  $x$ , calculate the maxima pressures, both with the reservoir full and empty, to see whether they reach the limit  $p$  or  $q$ . This will always occur first at the front face, as we have assumed  $p < q$ . When the limit  $p$  is reached, the next series of joints must be found by substituting in Equation (II)

$$u = \frac{2x}{3} - \frac{px^2}{6(w + \frac{(x+l)h}{2})}, \dots \dots (J) \quad n = \frac{x}{3};$$

after reducing, we obtain  $x^2 = \frac{6M}{p} \dots \dots \dots (4)$

This equation may be employed until the limiting pressure is reached at the back face. We must then determine the next joints by substituting in Equation (II)

$$u = \frac{2x}{3} - \frac{px^2}{6(w + \frac{(x+l)h}{2})}; \dots \dots \dots (J)$$

$$n = \frac{2x}{3} - \frac{qx^2}{6(w + \frac{(x+l)h}{2})} \dots \dots \dots (K)$$

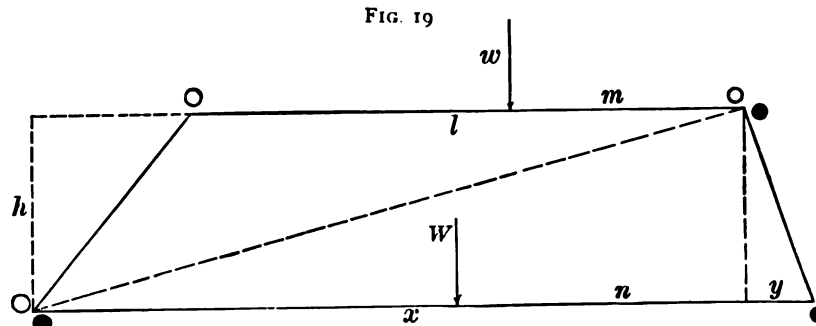
After reduction we find

$$x^2(p + q - h) - 2x\left(w + \frac{lh}{2}\right) = 6M \dots \dots \dots (5)$$

Equations (1) to (5) enable us to calculate successively the exact lengths of all joints, commencing at the top of the dam. However, Equations (3), (4) and (5), which apply to that portion of the dam where both faces slope, determine only the lengths of the joints, but not their position. This may be found by the following equations, which determine the batter of the back face of the given course:

$$\circ = \frac{lh}{6};$$

$$\bullet = \frac{xh}{6}.$$



In Fig. 19,  $w, m, l, h$  and  $x$ , which has been calculated by one of the given equations,

are known. The quantity to be found is  $y$ , the batter of the back face. The trapezoid  $\frac{(l+x)h}{2}$  will be replaced by six weights, as already explained in finding Equation (2). As the moment of the whole weight must equal the sum of the moments of its parts, we have, taking moments about the back edge of  $x$ ,

$$Wn = w(m+y) + \frac{h}{6}(l+x)y + \frac{h}{6}(l+x)x + \frac{h}{6}(l+y)l \quad \dots \quad (\text{III})$$

For Equations (3) and (4) the value found for  $y$  must make  $n = \frac{x}{3}$ .  
Substituting this value in the above equation, and also

$$W = w + \left(\frac{l+x}{2}\right)h, \quad \dots \quad (\text{H})$$

we shall find, after reducing,

$$y = \frac{2w(x-3m) - hl^2}{6w + h(2l+x)} \quad \dots \quad (6)$$

For Equation (5) we must have

$$n = \frac{2x}{3} - \frac{qx^2}{6\left[w + \left(\frac{l+x}{2}\right)h\right]} \quad \dots \quad (\text{K})$$

Substituting this value in Equation (III) we obtain, after reduction,

$$y = \frac{w(4x-6m) + ll(x-l) + x^2(h-q)}{6w + h(2l+x)} \quad \dots \quad (7)$$

Equations (1) to (5) are simply modifications of the general Equation (1), resulting from the changes in the controlling influence of the limiting conditions in the various parts of the dam. In the upper portions of the profile, the limiting of the positions of the lines of pressure to the centre third of the profile is the only important condition, whereas in the lower portions the amount of pressure in the masonry becomes the controlling consideration. What adds to the mathematical difficulties of finding simple equations for determining the proper profile is the fact that the changes in the controlling influence of the conditions do not occur simultaneously at the front and back face.

Feeling convinced that with such complicated requirements no regular mathematical curves or lines could be found for bounding a profile which should fulfil all the given conditions and at the same time involve a minimum amount of masonry, the writer, instead of following the methods hitherto proposed for determining at once a practical profile, adopted the plan of first finding by means of the equations given a *theoretical profile* upon which to base the practical design. The *theoretical profile* resulting from calculating the required thickness of a dam at regular intervals will have polygonal faces. By taking the value of  $h$  sufficiently small, we can determine a profile which shall fulfil all the given conditions and at the same time contain practically the minimum area. The only modification that remains to be made in this theoretical type to arrive at the practical design is to simplify its faces by fitting curves or straight lines to the theoretical form. The effect of small changes, made for this purpose, will be but slight as regards the given conditions.

In applying the equations to practical calculations we have assumed  $h = 10$  feet, as the numerical work is thereby greatly facilitated, and the transition from one equation to the other is so gradual that no difficulty is experienced in selecting the proper one.\*

The equations given thus far have been based upon the conditions of Prof. Rankine. *They are the only ones that we shall advance for designing profiles.* For sake of comparison, however, we shall show how Equation (II) may be adapted to the French conditions as given by MM. de Sazilly, Delocre and Pelletreau, with the difference that, for the reasons stated on page 20, the vertical component of the water-pressure will be omitted. The main difference between the principles adopted by these engineers and those of Prof. Rankine is, that in the former no restriction is placed upon the positions of the lines of pressure. So long as low limits of pressure are used no danger will result from this neglect, as  $P$  and  $P'$  will lie practically within the centre third of the profile. But when we take high limits of pressure—and the tendency of late has been in this direction—the lines of pressure will be very eccentric. With such limits the back face of a dam will be vertical for a great depth, and the effect of neglecting the vertical component of the water-pressure is therefore slight. The profile may be found by the following method:

The upper portion of the profile will be a rectangle, but instead of terminating where  $P$  reaches the limit of the centre third of a joint, it will be continued until the pressure at the front face reaches the limit  $p$ . Equation (I),  $x = u + v + n$ , is to be used with the following substitutions:

$$n = \frac{a}{2}; \quad v = \frac{M}{W} = \frac{d^3}{6ra};$$

$$u = \frac{2a}{3} - \frac{pa^3}{6W} \text{ (from formula A) if } u > \frac{a}{3},$$

$$u = \frac{2W}{3p} \text{ (from formula C) if } u < \frac{a}{3},$$

in which  $W = ad$ .

If  $u > \frac{a}{3}$ , we obtain

$$d^3 + ra^3d - pra^3 = 0. \dots \dots \dots (8)$$

If  $u < \frac{a}{3}$ , we will find

$$d^3 + \frac{4ra^3d}{p} = 3ra^3. \dots \dots \dots (9)$$

As we do not know *à priori* whether  $u$  will be greater or less than  $\frac{a}{3}$ , we can only determine by trial which Equation, (8) or (9), ought to be used.

The limiting pressure will evidently be reached sooner at the front than at the back face. The latter may therefore remain vertical for the next series of joints, whereas the former must be sloped to keep the maxima pressures equal to  $p$ . Substituting in Equation (II):

$$u = \frac{2}{3}x - \frac{px^3}{6\left(w + \left(\frac{l+x}{2}\right)h\right)} \text{ (J) if } u > \frac{x}{3},$$

---

\* A practical example of the use of equations (1) to (5) is given in the Appendix, page 403.

$$u = \frac{2\left(w + \left(\frac{l+x}{2}\right)h\right)}{3p} \quad (\text{from formulæ C and H}) \quad \text{if } u < \frac{x}{3},$$

and for  $n$  the same value found for Equation (2) by taking moments around the back edge of the joint, we obtain—

$$\text{If } u > \frac{x}{3},$$

$$px^3 + 2wx = 6wm + hl^3 + 6M. \quad \dots \quad (10)$$

$$\text{If } u < \frac{x}{3},$$

$$x^2\left(h - \frac{h^2}{2p}\right) + x\left(3w + lh - \frac{1}{p}(2hw + lh^2)\right) = 3M + 3wm + \frac{l^3h}{2} + \frac{1}{p}\left(2w^3 + 2wllh + \frac{h^3l^3}{2}\right). \quad (11)$$

As in the previous case, we can only determine by trial which of the above equations to use.

So soon as the limiting pressure has been reached at the back face, both faces of the dam will have to be sloped in order to keep the maxima pressures within the prescribed limits. Sazilly, Delocre and Pelletreau used the same limit of pressure for both faces; we shall, however, introduce  $p$  and  $q$  as in Equations (1) to (5). Let us first suppose that  $P$  lies within the centre third of a joint  $x$ , while  $P'$  lies without. Substituting in Equation (11)

$$u = \frac{2x}{3} - \frac{px^3}{6\left(w + \left(\frac{l+h}{2}\right)h\right)} \quad (J),$$

$$n = \frac{2\left(w + \left(\frac{l+x}{2}\right)h\right)}{3q} \quad (\text{from formulæ C and H}),$$

we obtain

$$x^2(hq + qp - h^2) + x[(q - 2h)(2w + lh)] = 6qM + lh(lh + 4w) + 4w^3. \quad \dots \quad (12)$$

Should  $P$  lie without and  $P'$  within the centre third of a joint, we must employ Equation (12), transposing simply the position of  $p$  and  $q$ .

If both  $P$  and  $P'$  are within the centre third of the joint, we obtain Equation (5), given on page 19.

Finally, if  $P$  and  $P'$  both are outside of the centre third, we obtain

$$x^2\left[\frac{h}{2}(3 - hz)\right] + x\left[3w + h\left(\frac{3l}{2} - lzh - 2ws\right)\right] = z\left[2w^3 + hl\left(\frac{hl}{2} + 2w\right)\right] + 3M, \quad (13)$$

in which  $z = \frac{p+q}{pq}$ .

The above equations cover all the cases that can arise, but some of them will never be needed for actual calculations.

The value of  $y$  will be found by using Equation (6) or (7), except when  $P'$  lies outside of the centre third of the joint. In this case

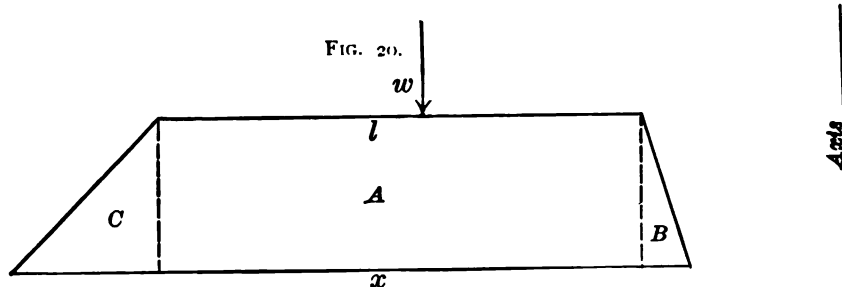


$$y = \frac{\frac{4W^2}{g} - 6wm - h(x^2 + xl + l^2)}{6w + h(2l + x)} \dots \dots \dots (14)$$

In the French methods of determining profiles, in which  $P$  and  $P'$  are not restricted to its centre third, there are always more or less trial-calculations involved, as it is not known in advance whether to employ formula  $\Lambda$  or  $C$  for expressing  $u$  or  $v$ . However, if we assume  $h = 10$  feet, the change from one equation to the other is so gradual that trial-calculations will seldom have to be employed.

In applying the equations given in this chapter to practical examples, it is advisable to check the calculations by some other method. This may be done readily by the principle of moments, as follows:

Assume a vertical axis at a convenient distance from the back face. After having found a value for a joint  $x$  by solving the proper equation, divide the corresponding course into a rectangle and one or more triangles by vertical lines, as shown in Fig. 20.



The moment of the weight  $w$  resting on the joint  $l$  about the axis is supposed to be known from the previous "check-calculation." Adding the weights of  $A$ ,  $B$  and  $C$  (the parts into which the course has been divided), expressed in cubic feet of masonry, to the weight  $w$ , and the moments of  $A$ ,  $B$  and  $C$  about the vertical axis to the moment of  $w$ , we obtain  $W$  (the total weight resting on the joint  $x$ ) and its moment about the axis. By dividing this moment by the weight  $W$ , we obtain the distance of the centre of gravity of the profile above the joint  $x$  from the axis; in other words, we have found where  $P'$  (the line of pressure, reservoir empty) cuts the joint  $x$ .

From the formula (G),  $r = \frac{M}{W}$ , in which  $\begin{cases} M = \text{moment of water,} \\ W = \text{total weight,} \end{cases}$  we find the distance from  $P'$  to the line of pressure  $P$  (reservoir full), measured on  $x$ . We can verify thus whether  $P$  and  $P'$  are within the prescribed limits. By means of formulæ A, B and C the maxima pressures at the joint  $x$  can be found, both for reservoir full and empty. These pressures should be within the given limits.

The value of the coefficient of friction which is necessary to prevent sliding can be found from (F) and Fig. 15 as follows:

$$f = \tan \alpha = \frac{v}{d} = \frac{3v}{d} \dots \dots \dots (L)$$

The factor of stability, which we shall denote by  $S$ , can be obtained thus:

$$S = \frac{W(u + v)}{M} \text{ (see page 19), but } M = vW \text{ (from G); hence } S = \frac{u + v}{v} \dots \dots (M)$$

## CHAPTER IV.

## VARIOUS APPLICATIONS OF EQUATIONS (1) TO (14).

IN the preceding chapter we have found the necessary equations for calculating *theoretical profiles*. We will now apply them to practical examples from which important deductions may be made.

**Necessity of Limiting the Positions of the Lines of Pressure.**—The maxima pressures in existing dams vary from 6 to 14 kilos. per square centimetre (about 6 to 14 tons per square foot), as may be seen in Table XXIII. The limit adopted for the Furens Dam was  $6\frac{1}{2}$  kilos. per square centimetre; for the Ban Dam, built subsequently, it was raised to 8 kilos.; and M. Græff in his memoir\* on the former structure gives a profile based upon 14 kilos. per square centimetre, which pressure has been safely sustained in the Almanza Dam for three centuries.

To study the effect of adopting the French conditions (see page 25) with high limits of pressure, we give in Plates VIII. and IX. two profiles calculated by Equations (8) to (14), assuming for the first,

$$\begin{aligned} p &= 8 \text{ kilos. per square centimetre,} \\ q &= 10 \text{ kilos. per square centimetre;} \end{aligned}$$

and for the second,

$$p = q = 14 \text{ kilos. per square centimetre.}$$

Tables VIII. and IX. give the necessary details.

The danger resulting from placing no limits to the positions of the lines of pressure is very apparent in these profiles; especially in No. 2, which corresponds to the one given by M. Græff for a limiting pressure of 14 kilos. per square centimetre. In this case the lines of pressure are so eccentric in the upper part of the profile, that a dam built according to this design would be very unsafe, and by no means have a "profile of equal resistance."

Although experience proves that pressures as great as 14 kilos. per square centimetre may be safely sustained in the lower portions of a dam, where the lines of pressure generally lie within the centre third of the profile; yet in the upper portions such pressures cannot be permitted, as they can only result from a dangerous eccentricity of one of the lines of pressure. We see, therefore, the necessity of adopting some principle besides the limiting of the stress on the masonry, in order to insure perfect safety in a dam.

If we add to the French conditions the one given by Prof. Rankine, which limits the positions of the lines of pressure to the centre third of the profile, no danger can

---

\* In the "Annales des Ponts et Chaussées," Sept. 1866.

arise in the upper portions of a dam, designed on this basis, on account of a high limit of pressure being assumed. Such a wall would always have a factor of safety against overturning of at least 2; would have no part subject to tension; and would also have ample safety against sliding or shearing, as will be shown in the next chapter.

**Weight of Masonry.**—The early writers on the subject of dams assumed the specific gravity of the masonry as 2. M. Krantz, in his book on "Reservoir Walls,"\* points out that this assumption introduces an error into the calculations, as the true specific gravity of good rubble masonry built of granite or limestone is about 2.3. M. Bouvier † gives the specific gravity of the masonry in the Ternay Dam, constructed of granite, as 2.36; M. Pochet ‡ places that of the Habra Dam, which was built of calcareous stone, at 2.15.

To show the influence of the weight of the masonry upon the form of the profile, we have calculated four profiles by Equations (1) to (7), assuming the specific gravity of the masonry respectively at 2,  $2\frac{1}{2}$ ,  $2\frac{3}{4}$ , and  $2\frac{1}{2}$ . The corresponding values of the moments of water ( $M$ ) are :

$$\frac{d^3}{12}, \quad \frac{d^3}{13}, \quad \frac{d^3}{14}, \quad \frac{d^3}{15},$$

the weights per cubic foot of masonry being 125, 135.41, 145.83, 156.25 lbs.

As the exact average weight of the masonry in a dam is generally unknown, we may adopt approximate whole numbers as the divisors of  $M$ , in order to facilitate the numerical work.

The four profiles are shown in Plate X. Tables X., XI., XII. and XIII. give the details.

If we compare the corresponding areas of these profiles at different depths, we shall find that for a depth of about 190 feet the area of profile diminishes as the weight of the masonry increases. For greater depths, however, this law will be reversed.

Not only will the amount of masonry required for a dam depend upon the specific gravity of the masonry, but this factor will also affect the form of profile, as will be noticed in Plate X.

**Vertical Component of the Water-pressure.**—Let us next examine the effect of including the vertical component of the water-pressure in our calculations. Taking profile No. 5 (Table XII.) and recalculating the maxima pressures at the front face, including the vertical component of the water-pressure in the total weight resting on a joint, we find as results the figures given in the table at the top of the next page.

This table shows that although by including the vertical component of the water-pressure a greater load has been placed upon each joint, yet, owing to the fact that the line of pressure has been moved back from the front face of the dam, the maxima pressures will be diminished.

The difference between the pressures calculated with and without the vertical component of the water-pressure increases gradually, amounting to 15 per cent at a depth of 200 feet. Now, this gradual reduction of the amount of pressure at the front face as its

\* Published in Paris in 1870.

† "Annales des Ponts et Chaussées," Aug. 1875.

‡ Ibid., April 1875.

1 DEPTH OF WATER. Feet.	MAXIMUM PRESSURE.		4 Numbers in Column 3 divided by Corresponding Num- bers in Column 2.
	2 Vertical Component of Water included in Cubic Feet of Masonry.	3 Vertical Component of Water excluded in Cubic Feet of Masonry.	
70	81.26	82.5	101
80	86.31	88.4	102
90	94.09	96.2	102
100	102.16	104.4	102
110	110.10	112.3	102
120	108.91	112.3	103
130	108.23	112.3	104
140	107.54	112.3	104
150	106.96	112.3	105
160	106.55	112.3	105
170	103.88	112.3	108
180	101.77	112.3	110
190	98.00	112.3	114
200	97.22	112.3	115

batter increases is precisely what one of Prof. Rankine's conditions requires. As this eminent writer admits that it is impossible, in our present state of knowledge, to find the law this diminution of stress ought to follow, it would seem sufficient to effect this object by simply omitting the vertical component of the water-pressure in the calculations.

There is another reason for adopting the above method. Formulæ A, B and C (page 10) have been obtained by assuming a dam to be perfectly rigid. It has been pointed out in Chapter II. that we must use caution in applying these formulæ, which after all are only approximately true, to extreme cases. Now by assuming in the case of a dam having a steep back face that a column of water resting near one edge of a long joint relieves the pressure at the other edge, we are carrying the hypothesis of rigidity to an unsafe extreme. It is certainly safer to overestimate than to underestimate the maxima pressures.

There is no theoretical difficulty in modifying the equations already given so as to include the vertical component of the water-pressure; but we shall obtain an equation of the fourth degree of such length as to be of no practical value. Various approximate methods of finding the desired result can readily be found. Thus Equations (1) to (5) may be used with the value of  $p$  increasing gradually below the joint, where the back face commences to slope, the increase being based upon the above table. When the pressures are afterwards recalculated with the vertical component of the water-pressure included in the loads, they will be found to be very near the fixed limit. The reasons given above show the advisability of neglecting the vertical component of the water-pressure, where

the up-stream face of a dam is steep, as any error that may result therefrom will be on the safe side; whereas by including the component in the equations we probably err in the other direction.

**Inclined Joints.**—In making calculations for the profile of a dam, it is customary to assume it to be divided into courses by horizontal joints. As these are imaginary, there is no theoretical reason why they should be assumed to be horizontal. The question naturally arises, what the effect would be of making calculations for inclined joints. In Plate XI., profile No. 5 is shown with joints radiating from points in the back face of the wall. By examining Table XIV., which gives the results of the calculations made for these joints, it will be seen that by inclining them downward from the back of the dam the maxima pressures are reduced; whereas by inclining them upward the opposite effect will be produced within certain limits. The angles made with a horizontal line which give the maxima pressures at a certain depth of water vary from  $20^{\circ}$ – $30^{\circ}$ . The increase of pressure resulting from inclining the joints, which at a depth of water from 60–110 feet amounts to only 14%, is 41% at a depth of 160 feet. In making these calculations the weight of the masonry below the joints has been omitted, as though the dam were cut in two parts. While this supposition is rather extreme, good rubble masonry would doubtless bear the resulting pressures.

Should we desire to increase the thickness of a dam on account of the pressures produced upon oblique joints, we can modify the Equations (1) to (14) according to M. Bouvier's method,\* so that the limiting pressure will not be exceeded in joints drawn perpendicular to the resultant pressure.

**Profile on Bouvier's Principle.**—Let us change profile No. 5 in accordance with the above. No alteration is necessary for the first 90 feet from the top of the dam, as the only important consideration for this part is that the lines of pressure must be within the centre third of the profile. Below this depth, as the pressures on the joints will be parallel with the resultant, we can take  $q$  for the limiting pressure at both faces. The corresponding limit of vertical pressure at the front face will be  $q \cos \alpha$ , in which  $\alpha$  is the angle which the resultant ( $R$ ) makes with a vertical line. The maxima pressures at the back face are of course calculated for horizontal joints, as they occur, when the reservoir is empty and  $R$ , therefore, vertical. To make Equations (1) to (14) agree with M. Bouvier's principle we need only substitute for  $p$  the pressure  $q \cos \alpha$ . The angle ( $\alpha$ ) is unknown, as its value cannot be determined until we have found the corresponding joint. But the difference in the inclination of the resultants from joint to joint is so slight, when these are only ten feet apart, that we can use the value of  $\alpha$  for the joint above the one to be determined, in the equations. This is the method we have followed in modifying profile No. 5 to agree with Bouvier's principle. The profile obtained thus is shown in Plate XII., the details being given in Table XV. By examining this table it will be seen how trifling the differences are in the value of ( $\alpha$ ) from joint to joint. The bottom width of the profile found by Bouvier's principle is 196.35 ft., and its area 15,662 sq. ft.; whereas for profile No. 5 we have respectively 190.98 ft. width and 15,157 sq. ft. area.

Although we have given this method for taking the obliquity of the pressures, when the reservoir is full, into account, our present knowledge of this subject is so uncertain

---

\* See page 16.

that it is a useless refinement to introduce it into the equations. For all practical purposes we need only consider horizontal joints, applying Equations (1) to (7) with such values for  $p$  and  $q$  as experience warrants.

**Comparison of a Theoretical Profile with Rankine's Logarithmic Type.**—Equations (1) to (5) have been based upon the conditions given by Prof. Rankine. The *theoretical profile* found by applying them differs, however, considerably from the logarithmic profile designed by that eminent engineer. For sake of comparison we have made calculations for a *theoretical profile* based upon the data used by Rankine. Plate IV. shows the profile and also the logarithmic type. Tables III. and IV. give the details.

For a depth of 140 feet both profiles are based upon exactly the same conditions and data; but below this depth there is a slight difference, which requires explanation. Prof. Rankine states, namely, in the report we have quoted on page 4, that the limiting vertical pressure should be diminished as the batter of the front face increases. He did not advance any law for this diminution, but simply designed his profile type in such a manner that the stress at the outer face at a depth of 160 feet would equal the pressure sustained in the Furens Dam at the same depth,  $6\frac{1}{2}$  kilos. per square centimetre. Having adjusted the logarithmic curves, adopted for the outlines of his design, with reference to this stress, and also to keep the lines of pressure practically within the centre third of the profile, Rankine was unable to regulate the pressures in the lower portions of the profile, as they are determined without any regard to theory by the logarithmic curves. He considered it an advantage that the outlines chosen for his profile-type made the pressures diminish rapidly at the front face of the lower portions of the dam; but if his principle be correct, the steeper the front face is kept within safe limits of pressure, the better.

In our *theoretical profile* we have retained the same limit of pressure for all parts of the dam, the result being shown in the following table:

DEPTH. Feet.	RANKINE'S LOGARITHMIC PROFILE.		THEORETICAL PROFILE.	
	Angle.	Pressure in Feet of Masonry.	Angle.	Pressure in Feet of Masonry.
100	52° 47'	122	54° 14'	103
110	49° 17'	124	54° 21'	112
120	45° 44'	123	54° 30'	122
130	42° 09'	119	48° 56'	125
140	38° 37'	114	45° 21'	125
150	35° 11'	107	44° 07'	125
160	31° 41'	99	42° 59'	125
170	28° 46'	90	41° 57'	125
180	25° 51'	81	40° 59'	125
190	23° 19'	73	39° 13'	125
200	20° 40'	64	38° 09'	125

The angles given above are made by the tangents of the front logarithmic curve and the lines forming the front face of the *theoretical profile*, respectively, with horizontal planes.

As the profile calculated by our equations has a steeper face than the logarithmic type, it can safely sustain greater pressures. At a depth of 180 feet the difference in the pressures in the two profiles for the same angles is about 8 per cent; at a depth of 200 feet it is less than 10 per cent. As the actual pressures will be somewhat reduced from what is given in the table by the vertical component of the water-pressure, which has been omitted in the calculations, there seems no necessity of reducing the limit of pressure in the lower portions of the dam.

Rankine gives the logarithmic profile only for 180 feet depth of water. If it be continued, the front face becomes very flat. Instead of such a profile having great strains near the front face at the base, it is much more likely that the thin toe of masonry at the front face transmits but little pressure, the stresses following short direct lines towards the base.

The *theoretical profile* agrees for a depth of 140 feet exactly with the conditions and data assumed by Prof. Rankine for his logarithmic profile, and the differences below the depth are but trifling. It will, therefore, be interesting to compare the corresponding areas of the two profiles (see Tables III. and IV.). The following comparison shows that the differences are always in favor of the *theoretical profile*:

DEPTH.	Rankine's Logarithmic Profile. Area in Square Feet.	Theoretical Profile. Area in Square Feet.	Differences in Favor of the Theoretical Profile.
0	0	0	0
10	200	187	13
20	426	374	52
30	679	565	114
40	973	792	181
50	1,303	1,074	229
60	1,674	1,419	255
70	2,098	1,842	256
80	2,577	2,347	230
90	3,119	2,930	189
100	3,734	3,589	145
110	4,431	4,322	109
120	5,221	5,129	92
130	6,116	6,018	98
140	7,129	7,011	118
150	8,278	8,116	162
160	9,581	9,337	244
170	11,055	10,678	377
180	12,728	12,142	586
190	14,621	13,746	875
200	16,765	15,510	1,255

From Plate IV., and from what has been said above, it will be seen that while the logarithmic profile has sufficient strength and graceful outlines, it is not a close approximation to the correct theoretical form.

In the next chapter we shall show how the *theoretical profiles* calculated by the equations we have given may form the basis of practical designs for masonry dams.

## CHAPTER V.

## PRACTICAL PROFILES.

THE practical profiles for masonry dams, which we shall establish in this chapter, will be based upon theoretical types containing the least areas consistent with the following conditions:

1st. The lines of pressure must lie within the centre third of the profile, whether the reservoir be full or empty.

2d. The maxima pressures in the masonry or on the foundation must not exceed certain safe limits.

3d. The friction between the dam and its foundation, or between any two parts into which the wall may be divided by a horizontal plane, must be sufficient to prevent sliding.

To these conditions, in which only the hydrostatic pressure of the water is considered, we must add:

4th. The dam must be sufficiently thick in all parts to resist the action of waves and shocks from floating bodies.

As what constitutes sufficient strength with reference to the last of the above conditions is a matter of judgment, in our present state of knowledge, we shall first determine the correct form of profile as regards the first three conditions, and modify it subsequently to satisfy the fourth.

The width of this profile at the highest elevation of the water-surface should evidently be zero. In the upper part of a dam the pressures in the masonry are so inconsiderable, that only conditions 1 and 3 need be considered in proportioning the profile. Within the limits of practice, however, a profile based upon the former condition will always satisfy the latter, as will presently be shown.

The profile which contains the minimum area consistent with condition 1 forms a right-angled triangle having its vertical side up-stream. As in such a section the centre of gravity of the area of the profile above any joint lies in a vertical line passing through the up-stream limit of the centre third of this joint, it follows that the line of pressure  $P$  (reservoir empty) will limit the centre third of the profile up-stream.

Denote the base of the triangular profile by  $x$ . By changing its length the value of  $\frac{u}{x}$  (see page 18) may be made to vary within the limits 0 and  $\frac{2}{3}$ .

In Equation (I),

$$x = u + v + n = u + \frac{M}{W} + n \text{ (see page 20),}$$

let us substitute

$$u = \frac{x}{3}, \quad n = \frac{x}{3}, \quad M = \frac{d^3}{6r}, \quad W = \frac{dx}{2}.$$



We shall obtain, by reducing,

$$x = \frac{d}{\sqrt{r}} \dots \dots \dots (15)$$

As  $x$  is proportional to  $d$ , the line of pressure  $P$  (reservoir full) will cut all horizontal joints in like manner as the base, and will form thus the down-stream limit of the centre third of the profile. We conclude, therefore, that the triangular profile whose base is given by Equation (15) has the minimum area consistent with condition 1.

Now let us investigate whether it fulfils condition 3. We have, from Equation (F), page 19,

$$f = \frac{H}{W} = \tan \alpha; \quad \text{but } H = \frac{d^2}{2r}, \quad W = \frac{xd}{2} = \frac{d^2}{2\sqrt{r}}.$$

Substituting these values in Equation (F), we find

$$f = \frac{1}{\sqrt{r}} = \tan \alpha \dots \dots \dots (16)$$

Let  $\beta$  = the angle between the faces of the triangular profile:

$$\tan \beta = \frac{x}{d}.$$

Substituting for  $x$  its value given in Equation (15), we obtain

$$\tan \beta = \frac{1}{\sqrt{r}}.$$

Hence we have

$$f = \tan \alpha = \tan \beta = \frac{1}{\sqrt{r}} \dots \dots \dots (17)$$

The coefficient of friction necessary to prevent sliding equals, therefore, the tangent of the angle at the top of the triangular profile. Taking  $r = 2$  and  $r = 3$  as the extreme limits of the specific gravity of the masonry that may occur, we find  $f$  to vary between 0.707 and 0.577. M. Krantz and other authorities place the limiting value of  $f$  at 0.75. The triangular profile satisfies, therefore, condition 3, and may be continued until the limit of pressure is reached.

The maximum pressure at any joint of this profile (reservoir full or empty) is given by formula B, page 10, according to which  $p = \frac{2W}{x}$ . As  $W = \frac{dx}{2}$ , we have

$$p = d \dots \dots \dots (18)$$

The depth of any joint below the surface of the water expresses, therefore, the maximum pressure in that joint in feet of masonry, whether the reservoir be full or empty.

When the limiting pressure has been reached, the triangular profile must terminate, and be continued by means of Equations (4) to (7) (pages 23 and 24).

Plate XIII. shows a triangular profile for a value of  $r = 2\frac{1}{2}$ , which we shall call Theo-

retical Type No. I. Table XVI. gives the necessary dimensions, etc. It is sufficiently strong in every respect to resist the hydrostatic pressure of the water; but to resist the action of waves, as required by the fourth of the given conditions, it must be modified.

The first step will evidently be to give it sufficient width at the top to resist the action of waves and shocks from floating bodies. If the dam is also to serve as a bridge this width may be still more increased, and will generally be between the limits of 2 to 20 feet.

The top of the wall ought also to be raised a certain height above the highest probable elevation of the water-surface. As the height of the waves will depend largely upon the extent of the reservoir and the depth of the water, high dams ought generally to have a greater super-elevation above the highest water-surface than low ones, and ought also to have a greater top width.

The following table, taken from M. Krantz's book on "Reservoir Walls," and M. Crugnola's work on "Retaining Walls and Dams," gives the top widths and super-elevation above the water-surface recommended by these engineers:

DEPTH OF WATER, IN METRES.	TOP WIDTH OF DAM, IN METRES.		TOP OF DAM ABOVE WATER, IN METRES.	
	Krantz.	Crugnola.	Krantz.	Crugnola.
5.....	2.00	1.70	0.50	0.50
10.....	2.50	2.00	1.00	0.90
15.....	3.00	2.30	1.50	1.30
20.....	3.50	2.50	2.00	1.50
25.....	4.00	3.00	2.50	2.00
30.....	4.50	3.50	3.00	2.40
35.....	5.00	4.00	3.50	2.80
40.....	5.00	4.25	3.50	3.00
45.....	5.00	4.50	3.50	3.25
50.....	5.00	4.75	3.50	3.50

A good rule for ordinary cases is to make the top width of the dam and the super-elevation of its crown above the highest water-surface one tenth the height of the dam, limiting the former to a minimum value of 5 feet, and the latter to a maximum value of 10 feet.

While it is always advisable to provide a reservoir with an overflow-weir sufficiently large to prevent the water from passing over the dam, yet the safest course in designing the profile will always be to assume the level of the water at the top of the dam. Greater freshets may occur than those upon which the size of the waste-weir was based; or, a great demand for water may lead the owners of the reservoir to raise the level of the overflow. In all the calculations for this book, the water-surface has been assumed at the top of the dam.

We shall now investigate what the effect will be of giving a certain top width to the triangular profile. The upper part of the wall will now evidently have a surplus strength with reference to the first three conditions. As this increase is only required near the top of the dam, we shall seek to reach the triangular profile in the shortest practical manner

by making the front face vertical until it intersects the sloping face of this profile. Plate XIV. shows the new design, which we shall call Practical Type No. 1.

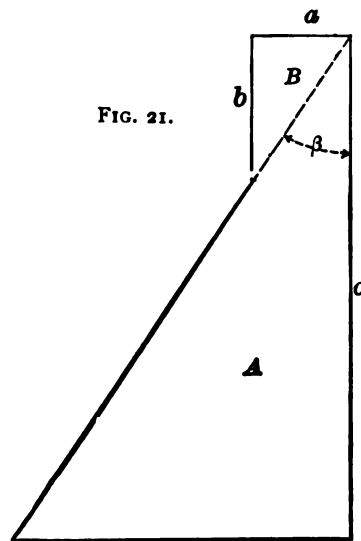
Let us determine to what extent the positions of the lines of pressure  $P$  and  $P'$  will be changed.

In Fig. 21 let

- $a$  = top width of dam;
- $b$  = length of vertical part of front face;
- $A$  = triangular profile at a given depth;
- $B$  = triangle added at the top of  $A$ ;
- $\beta$  = angle between the faces of  $A$ .

Using the letters given on page 18, we find:

	Area.	Moment about Back Face.
For $A$ , . . .	$\frac{d^2 \cdot \tan \beta}{2}$	$\frac{d^3 \cdot \tan^2 \beta}{6}$
For $B$ , . . .	$\frac{b^2 \cdot \tan \beta}{2}$	$\frac{b^3 \cdot \tan^2 \beta}{3}$



Hence, 
$$u = \frac{\text{Moment of } A + \text{Moment of } B}{\text{Area of } A + \text{Area of } B} = \frac{\tan \beta (d^3 + 2b^3)}{3(d^2 + b^2)},$$

and 
$$v = \frac{M}{W} = \frac{d^2}{3r(d^2 + b^2) \tan \beta} = \frac{d^2 \tan \beta}{3(d^2 + b^2)} \text{ (from (G) and (17)).}$$

Substituting the above values for  $u$  and  $v$  in Equation (1),  $x = u + v + n$ , and recollecting that  $x = d \cdot \tan \beta$ , we obtain

$$\frac{u}{x} = 1 - \frac{2(d^3 + b^3)}{3(d^2 + db^2)},$$

which expresses the distance of  $P$  from the front edge of a joint as a fraction of the length of the joint for any value of  $d \geq b$ .

To comply with condition 1 we must have

$$\frac{u}{x} > \frac{1}{3}.$$

If  $d = b$ ,  $\frac{u}{x} = \frac{1}{3}$ ; if  $d > b$ ,  $\frac{u}{x} > \frac{1}{3}$ .

By means of the Differential Calculus we find\*

Maximum value of  $\frac{u}{x} = 0.40392$ ;  
occurring at  $d = 1.67765b$ .

Below this depth  $\frac{u}{x}$  will continually approach the value  $\frac{1}{3}$ , reaching it when  $d$  becomes infinite.

---

\* Note A, page 385.

It can easily be shown that when  $d < b$ ,  $\frac{n}{x} > \frac{1}{3}$ .

Thus we see that for the important case of "reservoir full" the effect of the triangle  $B$  is to keep the line  $P$  within the centre third of the profile.

Let us now examine its influence on the line  $P'$ . Until  $d = 2b$ , at which depth the centres of gravity of  $A$  and  $B$  lie in the same vertical line, we shall have  $\frac{n}{x} > \frac{1}{3}$ .

Below this depth,  $\frac{n}{x} < \frac{1}{3}$ .

Applying the Differential Calculus, we find\*

$$\begin{aligned} \text{Minimum value of } \frac{n}{x} &= 0.32218; \\ &\text{occurring at } d = 3.1038b. \end{aligned}$$

From this depth down, the value of  $\frac{n}{x}$  will approach  $\frac{1}{3}$ , reaching it at an infinite distance. The deviation of  $P'$  outside of the centre third of the profile is so slight as to be of no practical importance. In examining the profiles designed by Rankine, Harlacher and Crugnola (see Tables III., VI., VII.), we find:

Profile.	Minimum Value of $\frac{n}{x}$ .
Rankine, . . . . .	0.308
Harlacher, . . . . .	0.316
Crugnola, . . . . .	0.325

In Prof. Rankine's profile we find that even  $P$  is allowed to deviate slightly outside the given limits, so as to give a minimum value of  $\frac{n}{x} = 0.308$ .

While it is best to confine  $P$  strictly within the centre third of the profile, so as to prevent all possibility of tension at the back face of the dam, a slight deviation from the centre third of the profile by  $P'$  may be permitted.

With reference to stability and shearing strength, profile  $A$  will evidently be improved by the additional weight  $B$ . We conclude, therefore, that by adding a section like  $B$ , with any top width, to the triangular profile, we obtain at once a Practical Type No. 1 (see Plate XIV.), which may be employed for any height that gives pressures at the base within the given limits. This type fulfils practically the four given conditions, and the only question which remains to be examined is whether it is the most economical profile which can be found.†

To investigate this subject we have calculated Table XVII. for a dam built according to Practical Type No. 1, the top width being assumed as 20 feet. We have also computed Table XVIII. for a theoretical profile having the same top width, and being based simply on the condition that it shall contain the minimum area that will keep the lines  $P$  and  $P'$  within its centre third. This profile, which we shall call Theoretical

\* Note B, page 385.

† A profile of this kind was proposed by Prof. Castigliano in the "Politecnico" for 1884.

Type No. II, will be found in Plate XV., the triangular profile (No. I) being shown by a dotted line for comparison. By comparing profiles I and II by means of Plate XV. and Tables XVI. and XVIII., we see that the effect of the area added at the top of No. II is twofold: 1st. To reduce the thickness of the profile from that of No. I; 2d. To move the lower part of No. II up-stream from the position of I.

As the influence of the wide top of No. II is offset by the reduction of its area lower down, this profile approaches the form of No. I as the depth increases, the corresponding faces becoming nearly parallel.

If we examine the batters of the faces of No. II we find that the front face forms a reverse curve, being first concave down-stream and then up-stream, approaching a line parallel with the front face of type I. The back face of No. II is first concave up-stream and then down-stream, approaching rapidly a vertical line.

Now before we compare No. II with the Practical Type No. 1 we must simplify its outlines to obtain a Practical Type No. 2. Plate XVI. shows this profile, and Plate XV. the theoretical type upon which it is based. Table XIX. gives the necessary dimensions, etc. The straight lines and circular curve which have been substituted for the many changes in the outlines in the theoretical type change that profile but slightly.

To compare the corresponding areas of the Theoretical Types I and II, and of the Practical Types 1 and 2, we have considered the area of No. I at any joint as the unit, and have obtained thus the following table:

DEPTH OF WATER, IN FEET.	THEORETICAL TYPES.		PRACTICAL TYPES.	
	I.	II.	1.	2.
0.....	Area. 0	Area. 0.000	Area. 0.000	Area. 0.000
20.....	I	3.055	3.055	3.055
40.....	I	1.561	1.583	1.579
60.....	I	1.186	1.259	1.196
80.....	I	1.064	1.146	1.080
100.....	I	1.027	1.093	1.041
120.....	I	1.013	1.065	1.027
140.....	I	1.007	1.047	1.022
160.....	I	1.004	1.037	1.018
180.....	I	1.002	1.029	1.016
200.....	I	1.002	1.023	1.015

The above table shows that the differences in the corresponding areas become rapidly less as the depth increases, the profiles being always in the following order as regards smallness of area: I, II, 2, 1. We conclude, therefore, that Practical Type No. 2 is always preferable to No. 1 as regards economy of material. Although the difference between their areas amounts to less than 1 per cent at the base, it is 5.3 per cent at a depth of 60 feet.

The relation between the areas of types I, II, 1 and 2, shown in the table above is general and does not depend upon the top width adopted. For, if we plot these

profiles to any scale, others, having any desired top width, may be obtained by simply changing the scale. The new profiles will always satisfy condition 1.

Thus far we have paid no attention to the pressures in the Practical Types 1 and 2, or to their resistance to sliding or shearing. As regards the pressures, Tables XVII. and XIX. show that they increase gradually in these practical types from the top to the base, where they reach the following maxima values for a height of profile of 200 feet:

	Maxima Pressures.	
	Reservoir full. Tons of 2000 lbs. per sq. ft.	Reservoir empty. Tons of 2000 lbs. per sq. ft.
Practical Type No. 1, . . . . .	14.35	15.16
Practical Type No. 2, . . . . .	14.32	14.65

The greatest of these pressures is but slightly in excess of the 14.33 tons per square foot (14 kilos. per square centimetre) sustained by the masonry of the Almanza Dam for over three hundred years without damage. While such pressures cannot be permitted in the upper part of a dam, where they could only result from a dangerous eccentricity of one of the lines of pressure, they can be sustained safely in the lower part, where the lines of pressure will be within the centre third of the profile. There is another important consideration which makes a gradual reduction of pressure from the top to the base of the dam advisable. The strength of the masonry depends, namely, on that of the mortar, whose resistance to crushing increases for a certain time with its age. A dam is weakest, therefore, when just built, its strength diminishing from the base to the top, where the masonry was laid last.

With respect to sliding or shearing, Practical Types 1 and 2 will have greater strength than the triangular type No. I, as their areas at any joint are respectively greater than that of the latter type, and hence give smaller values for  $f$  in the formula (F) (page 19). We have already demonstrated that the triangular type No. I has ample strength against sliding or shearing, and types 1 and 2 are still safer in this respect, as shown above.

When the limit of pressure has been reached in any of the types I, II, 1 or 2, more batter must be given to the faces by applying Equations (4) to (7). In this case the areas of the profiles will be greater than if the above-mentioned types had been continued to a corresponding depth, and consequently their resistance to sliding or shearing will also be increased. It follows, therefore, that so long as the lines of pressure are kept within the centre third of the profile, a dam will always have ample strength against sliding or shearing.

From what has been shown regarding the strength of the Practical Types 1 and 2 we can draw the general conclusion, that the profile of a dam which is to be built of ordinary rubble-masonry, weighing about 145 lbs. per cubic foot, can safely be based upon the first general condition given at the commencement of this chapter, provided its height does not exceed 200 feet. The Furens Dam, which surpasses all other reservoir walls in height, has a maximum elevation of 194 feet above its foundation. Higher dams may be built in the future, but will probably be exceptional. Condition 2, which limits the pressure in the masonry, will, therefore, but rarely have to be considered. As regards condition 3, we have shown that it is necessarily fulfilled by our satisfying condition 1.

The facts stated above make the design of an ordinary masonry dam, having a height

of less than 200 feet, a very simple matter. Standard profiles, similar to Practical Types 1 and 2, can be drawn for different weights of masonry, and can be used for lesser heights than their own (which is assumed as 200 feet) by simply changing the scale of the drawing. Tables giving the dimensions and strength of the derived profiles can be readily obtained from Standard Tables like Nos. XVII. and XIX. by the simple process of division explained in those tables. It can easily be proved that the derived profiles will satisfy the same conditions as the original types.

In establishing practical profiles for various heights we can adopt either Type No. 1 or No. 2; but as the latter satisfies rigidly the four given conditions, and at the same time contains practically the minimum area consistent with these conditions, and with the necessity for simple outlines, it is to be preferred.

Although this type might be used until a pressure of about 14 tons per square foot were reached, we shall assume for our practical profiles a limiting pressure of 8 kilos. per square centimetre (8.19 tons of 2000 lbs. per square foot) at the front face, and 10 kilos. per square centimetre (10.24 tons of 2000 lbs. per square foot) at the back face, in order to keep within the limits usually recommended by engineers. The specific gravity of the masonry will be assumed as  $2\frac{1}{2}$ . From Practical Type No. 2 we obtain, by the simple method explained above:

Practical Profile No. 1 (Plate XVII., Table XX.)—Top width, 5 feet; height, 50 feet.

Practical Profile No. 2 (Plate XVIII., Table XXI.)—Top width, 10 feet; height, 100 feet.

The third practical profile which we shall give will be based upon Theoretical Profile No. 5 (see Plate X. and Table XII.). To make this profile a practical design we have only to simplify its outlines. Small changes in this respect will have very little influence upon the strength of the profile.

We have adopted a curved outline for the front face and a few straight lines for the back face, obtaining thus:

Practical Profile No. 3 (Plate XIX., Table XXII.)\*—Top width, 18.74 feet; height, 200 feet.

This profile is the last illustration we shall give of the method we have advocated in this book, which consists in obtaining first a correct theoretical form, and then in simplifying its outlines. While we have required the theoretical profiles to fulfil rigidly the given conditions, it would evidently be a useless refinement to insist on the same accuracy for the practical design. As the theory of masonry dams has to be based upon hypotheses which are only approximately correct, we can permit the practical profiles to differ slightly from the given conditions.

How trifling the effect of changing the outlines of theoretical profile No. 5 has been will be seen by comparing Table XII. with Table XXII. Thus, the line of pressure  $P$  (reservoir full) remains within the centre third of the profile, and the line of pressure  $P'$  (reservoir empty) is only at two joints a little outside of this limit, viz.:

At a depth of 100 feet, 0.332 instead of 0.333

At a depth of 110 feet, 0.330 instead of 0.333

---

\* The results given in this table have been checked by the graphic process, as explained in Note C, page 386 (see Plate XX.).

A greater eccentricity than this will be found in the types of Rankine and Harlacher (see page 38).

The maxima pressures at some of the joints are slightly in excess of the fixed limits, the greatest difference, however, amounting to less than 3 per cent.

Practical Profile No. 3 has been based on the conditions given by Rankine, the maxima pressures at the up-stream and down-stream faces being limited, respectively, to about 10 and 8 tons per square foot. In recent constructions much higher limits of safe pressure have been assumed.

We have stated on page 41 that Practical Type II is to be preferred to Type I, as it contains practically the smallest area satisfying the given conditions. As far as simplicity of design is concerned, Type I will be preferred by many engineers to Type II. The difference between the areas of these two types is not very great (see Tables XVII and XIX), and when we consider how little is known of the actual distribution of pressures in a mass of masonry, it may not be advisable to insist on adopting rigidly the type that has theoretically the minimum area.

We cannot imagine a simpler profile than that given by Practical Type No. I. Although engineers generally give some batter to the up-stream face of the dam, the author knows of no theoretical or practical reason why the up-stream face of a dam should not be made vertical until the adopted limit of safe pressure is reached. At a depth of 200 feet this maximum pressure in Practical Type No. I is only about 15 tons per square foot, a pressure that can be safely supported by good masonry. The down-stream face in Practical Type No. I is built on one batter from the base to the vertical face at the top. The angle made by the battered and vertical parts of the down-stream face should be rounded off by a curve as shown in our Practical Profiles 1 and 2.

On Plate A we have compared our Practical Type No. I with the profile-types proposed by the different engineers mentioned in Chapter I. As these types are not based exactly on the same data, a fairer comparison of their respective methods can be obtained by the following table, in which we have also included the profile designed by Professor Harlacher for the proposed Komatau Dam.

COMPARISON OF PROFILE-TYPES.

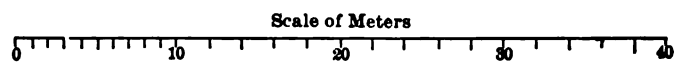
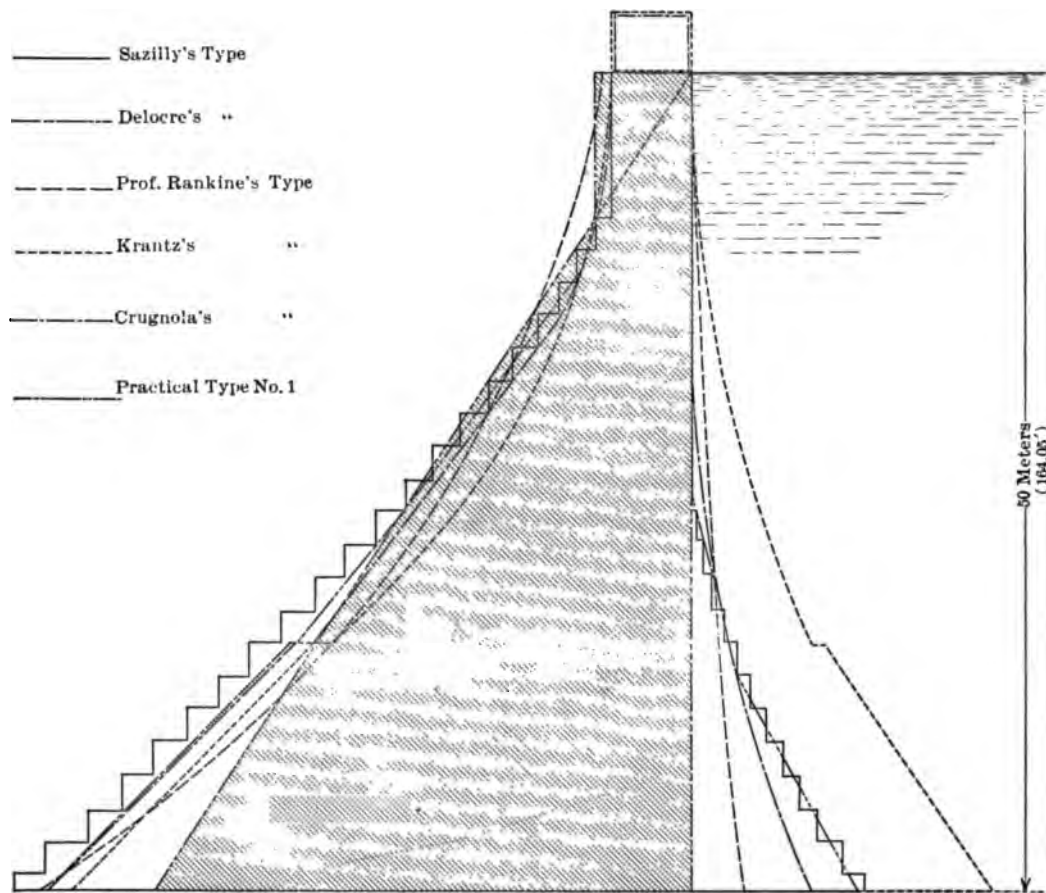
Type.	Top Width, in Metres.	Specific Gravity of Masonry.	Maxima Pressures, Kilos. per Sq. Centimetre.		AREAS IN SQUARE METRES—DEPTHS OF WATER.									
			Reservoir Full.	Reservoir Empty.	10	15	20	25	30	35	40	45	50	
					Metres.	Metres.	Metres.	Metres.	Metres.	Metres.	Metres.	Metres.	Metres.	Metres.
De Sazilly.....	5.00	2.070	5.99	6.00	50.80	86.78	147.47	213.31	288.21	377.36	474.00	577.11	681.90	795.89
Delocre.....	5.00	2.000	5.99	5.00	56.33	91.94	144.45	215.08	307.31	428.71	579.00	767.65	995.30	
Rankine.....	5.71	2.000	7.55	9.80	70.34	118.48	176.97	249.08	337.56	446.05	579.00	742.68	943.54	
Krantz.....	5.00	2.300	5.77	6.00	55.69	94.24	146.33	216.83	312.10	430.81	578.11	738.11	909.81	
Harlacher.....	4.00	2.200	6.73	5.75	44.35	79.85	132.05	205.75	300.40	418.92	558.00	728.00	906.00	
Crugnola.....	4.75	2.300	7.72	8.27	51.20	87.84	140.73	214.02	309.07	427.27	578.00	761.77	906.00	
Prac. Type, No. I	5.00	2.333	11.49	12.13	51.85	92.75	150.00	223.73	333.70	470.00	634.70	811.90	987.30	

The areas compared are entirely below the highest water-surface assumed for the respective types, the parts of the profiles above the water-surface being omitted.

The maxima pressures given occur within a limit of 50 metres depth of water.



COMPARISON OF PROFILE TYPES



11

.

▲

✓

.

No attention was paid in designing the profiles given in the above table to the pressure against a dam that might result from the expansion of ice, nor to an upward water pressure against the base of the dam. In some profiles designed in recent years \* these two forces have been taken into account. There is no positive information available about either of these forces. Ice, when confined as between bridge piers, may exert a great pressure in expanding, but in the case of a reservoir, which usually has sloping banks, it does not seem as though the ice could exert any great thrust against a dam.

As regards an upward water pressure, due to the head of water in the reservoir, some attention should be paid to this force in the case of very seamy foundations, but in most cases this force will be exerted only on a very small area of the base of the dam.

---

\* Quaker Bridge Dam (plan of Board of Experts), Wachusett Dam, Cross River Dam, and Croton Falls Dam, q.v.

## CHAPTER VI.

## CONSTRUCTION.

**Preliminary Investigations.**—The general location of a storage reservoir in a valley is determined by a consideration of the available watershed and by a topographical survey to ascertain the quantity of water that can be stored. The best site for a dam must be found by exploring the valley by means of diamond-drill and wash borings, trenches, and test-pits. The narrowest place of the valley is not necessarily the best location for the dam. The nearness of the bed rock to the surface and its character are very important factors in selecting the site where the dam can be built at the least cost. In studying the results obtained by the test borings and pits it is advisable to have the assistance of a good geologist, who may notice features of the rock formation that might escape the attention of the engineer.

**Plans.**—After the location of the dam has been determined, the engineer proceeds to prepare the plans for construction. We shall assume that a masonry dam has been decided upon. The first point to be considered is the alignment of the center-line of the dam, which may be a straight line across the valley, a broken line, or a curve. A masonry dam of considerable height must be founded on solid rock. Where the depth to bed rock varies considerably across the valley, a location on a broken line giving the least excavation to rock may be much more economical than a straight alignment, even though the length of the dam be somewhat increased.

When the valley which is to be closed by a reservoir wall is narrow, the idea naturally suggests itself to curve the plan of the dam so as to make it form a horizontal arch, convex up-stream, transmitting thus the thrust of the water to the unyielding sides of the valley. That under such circumstances a wall may resist the water pressure, when unable to do so merely by its weight, is proved by the Zola and Bear Valley dams.

The effect of curving the plan of a dam has been investigated mathematically by the French engineers Delocre and Pelletreau (see their memoirs in the *Annales des Ponts et Chaussées* for 1866 and 1876-1877); by Silas H. Woodward, Assoc. M. Am. Soc. C. E., in his paper on "Analysis of Stresses in Lake Cheesman Dam" (*Trans. Am. Soc. C. E.* for 1904), and recently, in connection with the design of the Pathfinder and Shoshone dams, by Edgar T. Wheeler, M. Am. Soc. C. E., under the direction of George Y. Wisner, Consulting Engineer of the Reclamation Service of the United States Geological Survey (see report made in May 1905 by Mr. Wisner to F. H. Newell, M. Am. Soc. C. E., Chief Engineer of the Reclamation Service, which is published in full in *Engineering News* for August 10, 1905).

Two questions arise in connection with a curved dam:

- 1st. Under what circumstances will a curved dam resist as an arch?
- 2d. When it does act in this manner, can the profile be reduced from what would be required if the plan were straight?

With reference to the first of the above questions, it is known that a stone structure will not act as an arch if its thickness at the crown is too great with reference to the radius. The limit-

ing value of this relation cannot be determined in the present state of our knowledge of the stability of arches, and it remains therefore a matter of judgment. M. Delocre thinks that a curved dam will act as an arch if its thickness does not exceed one third of the radius of its up-stream (convex) side. M. Pelletreau places the limiting value of the thickness at one half of this radius.

When a dam does act as an arch, it is evident that it can only transmit the water-pressure to the sides of the valley, and that its own weight must still be borne by the foundation. To investigate the horizontal thrust to which the masonry will be subjected under these circumstances, we will first imagine the dam to form part of a vertical shaft or well having to sustain the pressure of water only on its outer (convex) surface.

Such a structure ought evidently to have a circular plan, as it is subjected to a similar force all round.

Suppose the well to be divided into horizontal courses, each of them forming a ring composed of a number of voussoirs. As the only force acting on each ring in a horizontal direction is the water-pressure, it follows that the line of pressure (resistance) in each ring will form a circle passing through the centres of the voussoirs.

“The thrust round a circular ring under an uniform normal pressure is the product of the pressure on an unit of circumference by the radius.”\* It may therefore be expressed by the following formula:

$$T = pr, \quad (19)$$

in which

$T$  = the uniform thrust in the circular ring;

$p$  = the pressure per unit of length of the ring;

$r$  = the radius of the ring's outer surface.

Now if we remove part of the well and replace it by the practically rigid sides of the valley, we will have the case of a curved dam. The conditions in the masonry will remain unchanged, and the horizontal thrust in any course may be calculated by the above formula.

To find the maximum pressure exerted by this thrust on the masonry, we must know the position of the line of pressure. Pelletreau has assumed it to remain in the centre of each course, as in the case of a circular ring, the thrust being uniformly distributed on the masonry. Delocre places the position of the circular line of pressure on the up-stream limit of the centre longitudinal third of the course, and estimates, therefore, the maximum pressure on the masonry as twice the average pressure (formula B, page 14).

When a curved dam is subjected to the water-pressure it will yield slightly, owing to the elasticity of the masonry; but the sides of the valley will remain practically unchanged. It follows, therefore, that although we may calculate the horizontal thrust in any course by formula (19), as in the case of the circular well, the position of the line of pressure will be somewhat modified, approaching at the centre of the valley the up-stream face. The maximum pressure on the masonry will be greater than the average pressure, although probably not so large as assumed by M. Delocre.

It may be shown theoretically that, in the case of a narrow valley, a profile of less area may be adopted for a curved dam than for one whose plan is straight. M. Delocre comes to the conclusion that in either case, unless the height of the wall exceeds 84.85 metres (280.4 feet), its

---

\* Professor Rankine's "Applied Mechanics," page 184.

thickness at any given depth need never be greater than the width of the valley at that point. There is, however, so much uncertainty involved in the assumptions made in the mathematics of curved dams, that the best way to proceed in practice is to design the profile sufficiently strong to enable the wall to resist the water-pressure simply by its weight, and to curve the plan as an additional safeguard whenever the locality makes it advisable. This method is recommended by Rankine, Krantz, and other eminent engineers.

It is evident that the advantage to be derived from curving the plan of a dam is confined to narrow valleys; for in the case of those of considerable width, requiring a large radius of curvature the pressures in the masonry resulting from the dam's acting as an arch are considerably in excess of what they would be if each section of the wall resisted simply by its weight. Should such a long dam not act as an arch, then the curving of the plan, by adding length to the wall, would involve a waste of material. Aside, however, from any question of strength, the curving of the plan of a dam has the advantage of tending to prevent cracks in the masonry due to variations in temperature, which are almost sure to occur in straight dams.

As soon as the engineer has decided whether the dam is to have a straight or a curved plan, he can proceed to design the profile, which is to be determined by the principles discussed in the preceding chapters. In designing the dam he will have to decide upon the details how water is to be drawn from the reservoir and how the waste-water is to be discharged.

**Protective Works.**—Before the foundation trench for the dam can be excavated across the river-bed, the river must be diverted or coffer-dams must be constructed in the river to enclose a certain part of the work. In diverting the river a temporary dam is constructed across its bed, at a convenient distance above the site of the masonry dam, and the river is either turned into some lateral valley by means of a tunnel or a cut, or it is confined in a flume built along the side of the valley from the diverting dam mentioned above to a second temporary dam built some distance below the permanent dam, where the river is turned into its old channel. As the foundation excavation is made the flume must be supported by trestles. When the masonry has been carried up to the bottom of the flume, iron pipes are usually embedded in the dam and replace the flume through the dam, being connected to it at the up-stream and down-stream faces. The scour or outlet pipes of the dam may be used for this purpose or special pipes may be provided which are afterwards filled with concrete. If the river be too large to be confined in a flume, a temporary channel may be excavated for it on one side of the valley, and lined, if necessary, with masonry walls. In designing the flume or temporary channel, provision is usually only made, on account of the expense involved, for ordinary floods and not for extraordinary discharges of the river which are allowed to overflow the work.

When a river cannot be diverted and is too large to be confined in a flume or temporary channel, the dam will have to be constructed by means of coffer-dams. Two or more will be required. The dam is first brought up in these coffer-dams to the ordinary water line of the river. As the masonry is built higher a breach is left to take care of the river. This breach is finally closed at a time of low water, the river being passed through the dam by the outlet-pipes.

**Foundation Excavation.**—On account of the great width that must be given to the base of a masonry dam of considerable height, the foundation excavation must be made in "open trench." When bed-rock is reached, the excavation is continued a certain depth (3 to 5 feet), even if the rock is perfectly solid, in order to lock the foundation into the rock and to make it impossible for the dam to slide. Should the bed-rock be found to be too soft to bear the pres-

sure it is to bear, or full of seams, the excavation must be continued until a stratum of sufficiently solid and water-tight rock has been uncovered. In order to discover seams in the rock that may permit water to leak under the foundation, the excavation to rock should be made for some distance above the up-stream face. A number of test holes should, also, be drilled in the foundation rock to search for seams. This precaution is especially necessary if the foundation is on limestone, in which occasionally cavities occur.

In making the excavation one or more cableways for handling the material are a great convenience. They are usually stretched across the valley over the trench from towers erected on the hillsides, and are used, also, in laying the masonry.

**Masonry.**—Before any masonry is laid, the rock bottom should be swept clean and washed by water under pressure. All seams must be closed by concrete or grout.

Springs that are encountered in the foundation should be drained to some central point where the water is pumped. If the spring is under considerable pressure the water can be confined in a vertical pipe that is surrounded by masonry and is eventually filled with grout.

The masonry of which the dam is built may be cut stone, rubble, or concrete, or a combination of these kinds of masonry. As far as strength is concerned cut stone would be the best class of masonry for building a dam, but, on account of its great cost, it is only used at the faces of the dam and for the parapet and ornamental work at the top.

The inner part of the dam is usually built of rubble, concrete, or cyclopean masonry, which is a combination of rubble and concrete, large stones, just as they come from the quarry, being embedded in and surrounded by concrete.

In laying the rubble the stones should break joints in all directions. Horizontal courses should be avoided and the masonry should be made homogeneous so as to form as nearly as possible a monolith.

The rubble or concrete should be laid with special care at the faces so as to give the dam a good appearance. In many cases the down-stream face and that part of the up-stream face that is above the usual water line of the reservoir is made of cut stone or concrete blocks, which are laid normal to the faces and not horizontal.

It is not advisable to lay any masonry in a dam in very cold weather, but if it must be done the usual precautions are to be taken. The water and sand should be heated and some salt added to the mortar. The stones should be cleaned by a steam jet, and at night the freshly laid masonry should be protected by canvas covers, etc.

**Drainage System.**—However carefully the masonry be laid, a certain amount of leakage will always take place in a dam. This loss of water, which in a well-constructed reservoir wall shows itself only as a dampness on the down-stream face, generally disappears in course of time. As some water is likely to percolate into the masonry, a system of vertical drainage-pipes has been placed in some recent German dams and connected with a drainage-gallery, to discharge all the water that may enter the masonry. The vertical drainage pipes, which are about 4 inches in diameter, are usually placed with open joints in small shafts built in the masonry, about 6 feet from the up-stream face and about 8 feet apart. To make the seepage as small as possible the up-stream face of the dam is sometimes coated with a mixture of asphalt and coal tar, and a tight embankment is carried up, to almost half the height of the dam.

In the Vyrnwy Dam, in Wales, a system of drains is constructed in the foundation to relieve the base of the dam from the upward pressure that would occur if water leaked under the dam.

It is doubtful whether a system of drainage placed in the dam or its foundation is advantageous, except in special cases. By giving a free outlet to the seepage water such a system encourages leakage. Most engineers prefer to construct dams as tight as possible so as to offer the greatest resistance to seepage. Water that passes through a thick masonry dam and only shows itself as a moist spot on the down-stream side can scarcely be considered to cause an upward pressure in the masonry. On the contrary, in passing through the pores of the stones and mortar it increases the weight of the masonry and consequently the stability of the dam.

**Backfilling.**—As the masonry is carried up, the space between the dam and the slopes of the foundation trench should be carefully filled with suitable material. On the up-stream side this refilling should be placed with all the precautions taken in constructing tight earth dams. The refilling should be sprinkled with water and rolled so as to compact it as much as possible, in order to prevent the water in the reservoir from percolating to the base of the dam.

Usually the refilling on both sides of the dam is not carried up much above the former river-bed. In some dams built in Germany, however, according to the designs of Prof. Otto Intze, a tight earthen embankment is constructed on the up-stream side of the dam to half its height. Whether this is an advantage or not is a question. If the earth bank becomes saturated, it will cause a greater pressure against the dam than the water alone.

**Waste-weir.**—Unless a dam be designed to pass the waste-water from the reservoir over its crest, a special overflow-weir must be constructed. This weir may be located in the center of the dam, at either end or some distance from the dam, at some place where the waste-water may discharge into a lateral valley or into a tunnel driven through the hillside.

The crest of the waste-weir must be placed at a sufficient depth below the top of the dam (usually 5 to 20 feet) to prevent the water in the reservoir from flowing over the dam. The length of the waste-weir is to be determined by the usual hydraulic formulæ (see page 226). The profile adopted for the waste-weir is usually given a larger section than that adopted for the main dam. Its down-stream face is either stepped or curved. Examples of both kinds are given in the descriptions of dams contained in this book.

**Gate-houses.**—The outlet from the reservoir is usually made through two iron or steel pipes, which are embedded in the masonry at about the level of the former river-bed. The flow into these pipes is usually controlled by sluice-gates, placed in a gate-house, built on the up-stream side of the dam, and stop-cocks are usually, also, provided for the pipes in a vault built at the down-stream face of the dam. Occasionally local conditions make it advisable to construct the outlet from the reservoir at some distance from the dam.

The gate-house consists usually of a substructure containing the water-chambers, sluice-gates, etc., and of a superstructure that protects the hoisting machinery of the sluice-gates. The floor of the gate-house is usually placed at the level of the crest of the dam.

The substructure is divided by a partition wall into two water-chambers, one for each outlet-pipe. Each chamber has generally three inlet openings, protected by iron or brass screens, viz., one near the surface of the reservoir, one near its bottom, and the third about half-way between the other two. The screens slide in grooves cut in the masonry, and back of the screens a second set of grooves should be provided for stop-planks by means of which the gate-chambers can be separated from the reservoir whenever repairs may be required. Each of the water-chambers has a cross-wall in which openings are constructed that may be closed or opened by sluice-gates operated from the floor of the gate-houses.



**Sluice-gates and Stop-cock Valves.**—The first sluice-gates used were made of wooden logs roughly squared and bolted together. These gates were raised by chains and winches or by having racks attached, which were moved by pinions, held in standards and revolved by hand-wheels. While wooden sluice-gates of improved design are still used, cast iron has replaced wood in all important sluice-gates. Ribs are cast on the back of the gate in order to give it sufficient strength to resist the water pressure (Fig. 22). The gate slides usually in a cast-iron frame which is bolted to the masonry, the joint between the frame and the stonework being made tight by means of sulphur, lead, or cement. Guides for the gate are attached to the frames. In some modern gates one or more bronze-faced wedges are attached to the bottom of the gate and three or more



FIG. 22

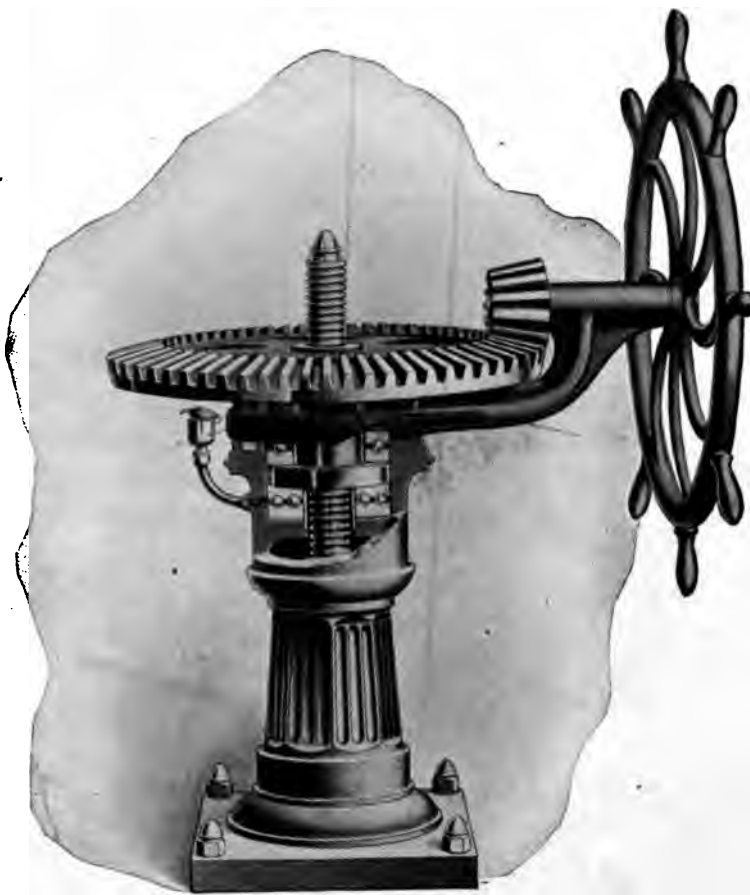


FIG. 23.

adjustable wedges on each side, which bear against the frame and insure the gate's closing tightly on its seat. A socket is provided on the back of the gate to receive the gate-stem or shaft, which is secured by cast-steel cotters. The face of the frame and that of the gate are mounted at all moving or bearing places with bronze, in order to prevent corrosion, and the gate and frame are carefully fitted together by planing and scraping so as to obtain perfectly water-tight joints. A screw-thread is cut at the upper end of the stem and engages with a bronze rotary nut, which is provided with a bearing collar which is securely fastened in a cast-iron standard placed directly above the gate at the point from which the sluice-gate is to be operated. By revolving the nut by hand-power or a motor the gate can be raised or lowered, as the case may be. If desired, the gate can be operated by hydraulic pressure. The simplest way of revolving the nut is by means

of a horizontal hand-wheel which is fastened by one or more keys to the nut (Fig. 25). When more power is desired for operating the gate, sockets for capstan-bars may be attached to the nut, or gearing may be used (Fig. 23).

A great deal of power is required for raising a large sluice-gate that is under considerable water pressure. In addition to raising the weight of the gate and its stem, which hang from the operating nut, the friction of the gate on its bearings and between the operating nut and the plates that hold it in place must be overcome. The last-mentioned friction may be very greatly reduced by introducing ball-bearings both above and below the nut collar. Such an arrangement, which has been patented by the Coffin Valve Company of Boston, Massachusetts, is shown in Fig. 23. The balls are made of steel and are placed in "races" in thin lubricating oil. The lower ball race, which has to support the entire weight, of the gate and its stem, is provided with a double set of balls, but only one set is used for the upper race which takes the thrust caused in closing the gates.



FIG. 24.



FIG. 25.

Instead of balls, slightly tapered rollers may be used. Figs. 24 and 25 show such an arrangement, which is manufactured by the Coldwell, Wilcox Company of Newburgh, New York.

The discharge of a sluice-gate is usually calculated by the formula

$$Q = ca(2gh)^{\frac{3}{2}},$$

in which

- $Q$  = quantity in cubic feet per second;
- $c$  = coefficient determined by experiment;
- $a$  = area in square feet;
- $h$  = head in feet;
- $g$  = the acceleration of gravity.

The value of  $c$  depends upon how the gate is set. It varies from about 0.60 to 0.80, according to whether the gate is set against a thin wall or against a short sluiceway. In the former case the gate opening may be considered to be an orifice, while in the latter it approaches closely to the condition of a short tube.

**Buttressed and Arched Dams.**—Thus far we have only considered dams that have uniform profiles, beginning at the top. The question arises whether any saving in masonry might be effected by reducing the area of the profile and strengthening the dam at regular intervals by buttresses or counterforts, or by building a number of isolated piers joined by vertical or inclined arches.

As far as the author knows, buttresses have not been used, to the present time, as part of the original plans for masonry dams, although they have been built subsequently in several cases to strengthen dams that were found to have insufficient strength (the Gros Bois Dam, the Gorzente Dam, q.v.).

In 1896 a low masonry dam—consisting of piers placed 28 feet apart and joined by curtain walls 4 feet thick, in which a number of I beams were placed—was completed at Princeton, New Jersey, to form Carnegie Lake.

In preparing plans for a concrete dam at Ogden, Utah, which was to be 369 feet long and 105 feet high above the foundation, Henry Goldmark, M. Am. Soc. C. E.,\* proposed to make the structure consist of a number of piers 16 feet wide, placed 32 feet apart in the clear, which were to support inclined segmental arches. Water-tightness was to be insured by facing the arches with steel plates. Bids obtained for building this dam according to this plan and also for constructing it as an ordinary "gravity dam" showed a saving of 12 to 15 per cent in favor of the former plan. Thus far this dam has not been built, but the Meer Allum Dam, India (q.v.), and the Belubula Dam (q.v.) in New South Wales, were built on this principle.

In a paper on "A Proposed New Type of Masonry Dam" † George L. Dillman, M. Am. Soc. C. E., demonstrated mathematically that a saving in material may be effected by building a dam of piers and arches instead of a uniform wall. In the type proposed by Mr. Dillman the portions between the buttresses are made parabolic in horizontal section, so as to avoid all re-entrant angles.

It appears that some saving in material results from such a plan of construction, and a similar style has been generally adopted for reinforced concrete dams (see Chapter XIII), which consists of buttresses, placed 12 to 15 feet apart, joined by a water-tight deck.

---

\* "The Power Plant, Pipe-line and Dam of the Pioneer Electric Power Company of Ogden, Utah," by Henry Goldmark, Trans. Am. Soc. C. E., for December, 1897.

† Trans. Am. Soc. C. E. for December, 1902.

## CHAPTER VII.

## SPANISH DAMS.\*

**The Almanza Dam** <sup>^</sup> (Plate XXI).—The oldest existing masonry dam is that of Almanza, situated in the Spanish province of Albacete, near the town after which it is named. The exact date of its construction is unknown, but it appears from old documents that it was in use prior to 1586.

It was founded on rock, and was built of rubble masonry, faced with cut stone except for the upper twenty feet of the front face, which was built of rough ashlar with courses of cut stones at certain intervals. The lower part of the dam, having a height of about 48 feet, is built on a curved plan, convex up-stream, the radius of the back face being 26.24 metres (86.07 feet). The remaining part of the wall, which was probably constructed at a later period, has a plan whose centre line forms a broken line 292 feet long. The greatest height of the dam is 20.69 metres (67.86 feet).

An overflow was formed by excavating the rock on one side of the dam 6.56 feet below its top for a length of about 39 feet.

Water is taken for the purpose of irrigation through a gallery 1 metre (3.28 feet) square, which passes through the lower portion of the wall. Above the down-stream end of this outlet-channel a chamber is constructed in the dam, where the bronze gate which regulates the flow of water from the reservoir is operated. To prevent the outlet-gallery from being closed by sediment, the gate is always partially opened during floods.

There is another gallery, 1.3 metres (4.26 feet) wide by 1.5 metres (4.92 feet) high, constructed through the dam, and serving for scouring out the deposits of sediment in the reservoir. In our description of the Alicante Dam we shall give a detailed account of the manner in which this operation is performed.

For many years the Almanza reservoir has not been filled, as the water is drawn off twice per annum for irrigation.

Although the old Spanish dam described above is not well proportioned, it is an interesting fact that its masonry has sustained safely for three centuries a greater pressure than exists in any other reservoir wall, namely, 14 kilos. per square centimetre (14.33 tons of 2000 lbs. per square foot).

**The Alicante Dam** <sup>^</sup> (Plate XXII).—The highest Spanish dam is that of Alicante,—named also, after a village near its site, the Dam of Tibi. It was built during the years 1579 to 1594, to supply the arid region of Alicante with water for irrigation. Although the name of its constructor is not known with certainty, there are reasons for ascribing this work to Herreras, the famous architect of the Escorial palace.

The gorge of Tibi, which is closed by this dam, is formed entirely of hard calcareous rocks, the slopes on either side standing almost perpendicular. Its width is only 30 feet at the bottom, and 190 feet at the crown of the dam.

---

\* The dams marked <sup>^</sup> are taken from "Irrigations du Midi de l'Espagne," par Maurice Aymard. Paris, 1864.

The river Monegre which flows through this gorge discharges on an average about 50 gallons per second.

The length of the Alicante reservoir is 5900 feet, its capacity being about 975,000,000 gallons.

The dam is built of rubble masonry faced with large cut stones. Its greatest height on the up-stream side is 41 metres (134.5 feet). The plan of the dam is curvilinear, the radius of the up-stream side of the crown being 107.13 metres (351.37 feet).

The maximum pressure in the masonry is 11.28 kilos. per square centimetre (11.54 tons of 2000 lbs. per square foot).

Water is taken from the reservoir by means of a well, 0.8 metre (2.62 feet) in diameter, which is placed in the dam itself. It is parallel with the up-stream face, and at a distance of about 2 feet from it. Fifty-one pairs of openings connect the well with the reservoir; they are 0.11 metre (0.36 foot) wide by 0.22 metre (0.72 foot) high, and are 0.3 metre (0.98 foot) apart horizontally and 0.41 metre (1.34 feet) vertically. The first pair is 6.97 metres (22.88 feet) below the top of the dam, and the last 2 metres (6.56 feet) above the bottom. By means of this arrangement water can be taken into the well even when much sediment has been deposited in the reservoir.

The outlet-well connects at the base of the dam with a horizontal gallery which is parallel with the up-stream face until it reaches the side of the gorge, where it is continued by a small tunnel 0.6 metre (1.97 feet) wide by 1.7 metres (5.58 feet) high. This tunnel curves so as to discharge the water parallel with the axis of the valley. The outlet-gallery is closed at the down-stream face of the dam by a bronze gate, two inches thick, giving an opening when completely raised of 1.77 feet width by 2.30 feet height. Immediately over the gate a small chamber has been cut in the rock, where the gearing for raising the gate is placed. By means of a hand-wheel and gear-wheels engaging a rack, which is attached to the gate, one man can raise or lower the latter with ease, even when the reservoir is full. To prevent incrustations which might obstruct the gate, a small stream of water is always allowed to escape there.

It was originally intended to have the outlet-gallery directly across the dam from face to face; but this would have brought it in close proximity to the scouring-gallery, presently to be described. Fears were entertained that such a construction would cause considerable leakage, and the outlet-gallery was therefore turned towards one side of the gorge, as described above.

We will now explain the construction and use of the scouring-gallery. Owing to the steep declivity of the beds of most Spanish streams, and to violent storms, large quantities of fine material which has been pulverized by the action of the water are deposited in the storage reservoirs. Unless some means were provided to remove this sediment, it would soon fill these basins completely. In 1843, when the Alicante reservoir had not been cleaned for fourteen years, a bank of sediment 75 feet high at the dam had been deposited. Since then the reservoir is scoured once in four years, the maximum height of the material deposited during that time being 39 to 52 feet.

Long experience has taught the Spaniards the best method of removing these deposits, namely, by means of scouring-galleries. In the Alicante Dam such a gallery is placed in the axis of the valley, crossing the dam in a straight line from face to face. Its

up-stream opening is 1.8 metres (5.9 feet) wide by 2.7 metres (8.86 feet) high. The gallery has this cross-section for the first 2.7 metres (8.86 feet) of its length, and is then suddenly enlarged to a section of 3 metres (9.84 feet) width by 3.3 metres (10.82 feet) height. After this the cross-section is increased gradually, so that it is 4 metres (13.12 feet) wide by 5.85 metres (19.18 feet) high at the down-stream face of the dam. By this increase in the cross-section of the gallery, which takes place in all directions, the material forced out of the reservoir by the water-pressure can expand freely and does not obstruct the channel through the dam.

The mouth of the scouring-gallery is closed simply by a timber bulkhead formed as follows: First a vertical row of beams about 1 foot square is placed, their ends projecting into horizontal grooves cut into the solid masonry. The last beam which closes the row is somewhat shorter than the rest, and enters only the lower groove. After the joints between the beams have been calked, a second row of similar timbers are placed directly behind the first row, but are laid horizontal, their ends being secured in vertical grooves in the sides of the gallery. Behind the second row three vertical posts are placed, each of which is firmly held by two inclined braces whose lower ends project into the floor of the gallery.

The banks of sediment formed in the reservoir acquire considerable consistency if left undisturbed for a few years. When it is necessary to scour the reservoir it becomes thus possible to remove gradually the timbers at the inlet of the gallery without much danger to the workmen. The timbers of the course next the reservoir are cut, one by one, with the greatest precaution. Should any movement be perceptible in the deposited material the men abandon their work, which will be quickly completed by the water-pressure.

Generally, however, the opposite of this takes place. The sediment forms a solid bank in front of the scouring-gallery, and does not move until a hole has been made through it from the top of the dam. The heavy iron bar which is employed for this purpose at the Alicante reservoir is 0.2 feet square, 59 feet long, and weighs about 1100 lbs. It is worked by means of a windlass and pulleys. When a hole has been pierced through the bank of sediment, the scouring action begins, first slowly, but soon gaining a tremendous force. All the sediment, except that in remote parts of the reservoir, is forced through the scouring-gallery, the noise made by this violent action being like that of cannons. Nothing remains for the workmen to do but to shovel the remaining sediment into the current. Sometimes the deposit has become so hard that it must be undermined from the scouring-gallery before a hole is pierced in it by the long bar. The total cost of scouring the reservoir, including the loss of timbers which are cut, amounts to only fifty dollars.

Although the method of cleaning the reservoir, which we have described in detail above, seems at first sight rather primitive, yet, on second thought, it will be found to be practical. Where such deep deposits are made gates are out of the question, as they would have to be frequently opened to prevent their becoming useless, and would cause thus a considerable loss of water.

While the scouring operation as carried on at the Alicante Dam certainly involves danger to the workmen, accidents are very rare. In our description of the Elche Dam we will show how this danger may be avoided.

The Alicante Dam had originally no waste-weir. However, one was built in 1697, as the wall was supposed to have been injured by water flowing over its top. During the freshets of 1792 the depth of the water on top of the dam was 8.2 feet, and it fell in a perfect cascade over the front face. The wall sustained this severe test so successfully that since then the waste-weir has been closed, no fears whatever being entertained of the stability and strength of the dam.

The cost of the construction of the great work we have described was borne entirely by the parties interested in the irrigation of Alicante.

**The Elche Dam<sup>A</sup>** (Plate XXIII).—This reservoir wall is situated on the Rio Vinolapo, near the town of Elche. Like the dams already described it was founded on rock, and constructed of rubble masonry faced with cut stones. Its maximum height is 23.2 metres (76.1 feet).

The Elche reservoir is formed by three walls, which close converging valleys. The principal dam is about 230 feet long, measured on its crest, and is built according to a curved plan, the radius of the back face being 62.6 metres (205.38 feet).

No overflow-weir was provided, as perfect confidence was felt in the dam being able to withstand the flow of water over its crest without injury. In 1836, however, a considerable breach was made in the wall by water passing over it during a great flood.

In many details the Elche Dam resembles that of Alicante. Thus, water is taken from the reservoir by means of a vertical well which was built in the wall near its up-stream face, and has inlet openings at regular intervals. This well terminates in a horizontal gallery, which passes through the dam like that of Alicante, and has its down-stream end closed by a bronze gate operated from a chamber immediately above it.

The arrangement of the scouring-gallery, however, is a great improvement on that of the Alicante Dam. Immediately above it a working gallery is placed, which enables laborers to remove the last timbers of the gate which closes the scouring-gallery, with perfect safety. Above the scouring-gate there is a well-hole in the working gallery through which these timbers are pulled out by means of ropes.

**The Puentes Dam<sup>A</sup>** (Plate XXIV).—The construction of the Puentes Dam was considered one of the great achievements of the reigns of Charles III. and Charles IV. of Spain. It was built during the years 1785 to 1791 at the place where the united waters of the Velez, Turrilla and Luchena form the Guadalantín River. After being in use for eleven years it was finally destroyed in 1802.

The maximum height of this dam was 50 metres (164 feet); its length measured on the crest was 282 metres (925.3 feet). The whole wall was built of rubble masonry, faced with large cut stones. The outlines of the plan were polygonal, being convex up-stream. The dam was finished with a magnificent parapet, upon which colossal statues of the two kings mentioned above were to have been placed.

According to M. Aymard, the maximum pressure in the masonry was 7.93 kilos. per square centimetre (8.12 tons of 2000 lbs. per square foot).

An arched scouring-gallery 6.7 metres wide by 7.53 metres high (22 feet by 24.7 feet) was constructed through the dam. At its up-stream end a central pier divided it into two channels, in order to reduce the span of the beams forming the scouring-gate.

Water was taken from the reservoir by means of two wells, each of which terminated

in a horizontal gallery 1.65 metres wide by 1.95 metres high (5.4 feet by 6.4 feet). These galleries were placed at different elevations, one being about 100 feet below the top of the dam, and the other near its base at the level of the scouring-gallery. The cross-section of the wells was about 4.2 metres by 2.5 metres (13.8 feet by 8.2 feet), and was rectangular, except that the side nearest the reservoir was formed by a circular arc. Each well had inlet openings, 0.28 metre wide by 0.55 metre high (0.92 foot by 1.80 feet), placed in rows of three, the vertical distance between the openings being 0.83 metre (2.72 feet).

According to the original intention the wall was to have been founded entirely on rock. In the centre of the valley, however, a deep pocket of earth was encountered, and it was unfortunately decided to build the wall at this place on a pile foundation. The masonry was sunk about 7 feet into the gravel around the piles, which projected above the horizontal caps. As the scouring-gallery and one of the outlet passages discharged in the centre of the valley, where the pocket of soft material was found, the ground at this place was protected against being washed out by a timber grillage resting on piles, which was continued for 131 feet down-stream from the front face of the dam. This timber apron was covered by about 7 feet of masonry, which was protected against the erosion of the water by planks.

The whole pile foundation was built very securely, and it would have answered all purposes had the depth of the water in the reservoir been less. This is shown by the fact that for eleven years, during which time the depth of the water in the reservoir never exceeded 82 feet, the wall stood perfectly safe. However, on the 30th of April, 1802, the water rose to an elevation of 154 feet above the base of the dam and the foundation gave way.

The following account of an eye-witness of the accident is taken from M. Aymard's book on the "Irrigation of the Southern Part of Spain":

"About half-past two on the afternoon of the 30th of April, 1802, it was noticed that on the down-stream side of the dam, towards the apron, water of an exceedingly red color was issuing in great quantities in bubbles, extending in the shape of a palm-tree. About three o'clock there was an explosion in the discharge-wells that were built in the dam from top to bottom, and at the same time the water escaping at the down-stream side increased in volume. In a short time a second explosion was heard, and, enveloped by an enormous mass of water, the piles and timbers which formed the pile-work of the foundation and of the apron were forced upwards.

"Immediately afterwards a new explosion occurred, and the two big gates that closed the scouring-gallery, and also the intermediate pier, fell in. At the same instant a mountain of water escaped in the form of an arc. It looked frightful, and had a red color, caused either by the mud with which it was charged, or by the reflection of the sun. The volume of water which escaped was so considerable that the reservoir was emptied in the space of one hour.

"The dam presents since its rupture the appearance of a bridge, whose abutments are the work still standing on the hillsides, and whose opening is about 56 feet broad by 108 feet high.\*

---

\* Mr. Crugnola states that this dam has been lately rebuilt ("Muri di Sostegno e Traverse dei Serbatoi," page 275.)



“At the moment of the accident the effective depth of the water was 334 metres (109.6 feet). Its surface was 46.80 metres (153.54 feet) above the base of the dam; the lower 13.40 metres (44 feet) being taken up by deposited material.”

This fearful accident caused the loss of 608 lives, the destruction of 809 houses, and of property amounting to about 5,500,000 francs (1,045,000 dollars).

The cause of the failure of the Puentes Dam is seen clearly in the account we have given above. The wall was not overturned or crushed by the pressure it had to sustain, but failed because it was undermined by the great water-pressure forcing a way through the soft material in the centre of the valley.

The rupture of the Puentes Dam teaches the important fact that a high masonry dam, however well proportioned, will only be safe if founded entirely on rock.

**The Dam del Gasco,**<sup>A</sup> across the Guadarrama River, was commenced in 1788. Its general dimensions were to have been as follows:

	Metres.	Feet.
Height, . . . . .	93	305.12
Thickness at base, . . . . .	72	236.22
“ “ top, . . . . .	4	13.12
Length on crown, . . . . .	251	82.35

It was constructed on a straight plan, and was to consist of two walls, 2.8 metres (9.18 feet) thick, connected by cross-walls. The compartments which were thus formed were to have been filled with dry stones imbedded in clay.

In 1799, when the dam had already attained a height of 57 metres (187 feet), a heavy rain-storm caused the river to flow over its top. The swelling of the clay, resulting from its becoming wet, forced over part of the front wall, and the dam was never completed.

**The Dam of the Val de Infierno**<sup>A</sup> (Plate XXV).—The region around the town of Lorca in the Spanish province of Murcia was formerly supplied with water for irrigation by the reservoir of the Val de Infierno. The masonry dam which forms this reservoir is situated in the gorge of the Rio Luchena, a branch of the Guadalantín River. Owing to the opposition of the land-owners below the site of the dam, who claimed that the scouring of the sediment injured their property, the reservoir has not been used for years, and is now completely filled with deposits. When the river is high it forms a beautiful waterfall over the old dam.

The greatest height of this reservoir wall is 35.5 metres (116.5 feet). It was originally intended to build the dam 16 feet higher, but this plan was abandoned as it would have caused the reservoir to include a permeable bank within its limits.

The plan of the dam has polygonal outlines, approaching very closely to arcs of circles, convex up-stream. The wall is founded entirely on rock.

An arched scouring-gallery, having a uniform height of 4.5 metres (14.8 feet) and a width of 3.75 metres (12.3 feet), except for 16.4 feet from its up-stream end, where its width is only 2.75 metres (9.0 feet), passes through the wall.

There are also two outlet-galleries, placed at different levels and arranged like those

of the dams of Alicante and Elche. The vertical wells with which they are connected at the up-stream face of the dam have inlet-openings 0.3 metre wide by 0.5 metre high (0.98 foot by 1.64 feet), placed 3 metres (9.84 feet) apart. This distance is too great. When the deposits close the openings at one level, no water can be drawn out of the reservoir until the water-surface has been raised about ten feet. Part of the up-stream sides of the wells has been torn down in order to facilitate the drawing of water, which makes the dam practically like the primitive one of Almanza, where no wells at all were used.

The reservoir of the Val de Infierno was constructed during the years 1785 to 1791.

**The Nijar Dam<sup>A</sup>** (Plate XXVI).—This reservoir wall is situated in a gorge of the Carrizal River in the small village of Nijar, near the town of Almeria. It was designed by the architect Geronimo Ros, and was constructed during the years 1843 to 1850. This dam was founded on rock and built of rubble masonry faced with cut stone. The lower portion of the wall consists of a foundation-mass of masonry, having a width in the direction of the valley of 43.89 metres (144 feet). This masonry extends 11 metres (36.1 feet) down-stream and 12.29 metres (40.3 feet) up-stream beyond the wall proper. The down-stream face of this foundation-mass is carried up in steps, as shown in Plate XXVI. The maximum height of the dam above the bed of the river is 30.93 metres (101.5 feet).

A scouring-gallery, 1 metre wide by 2.19 metres high (3.3 feet by 7.2 feet) passes through the wall. At its up-stream entrance it is only 1.72 metres (5.6 feet) high. It is closed by a gate which is operated from the top of the dam by means of a long rod. Immediately over the gate there is a vertical well, 1 metre in diameter, in the wall, which enables the workmen to examine the gate without being exposed to danger.

Water is drawn from the reservoir by means of a vertical well and a horizontal gallery, as in the other dams we have described. The diameter of the well is 2.72 metres (8.9 feet). A winding staircase in the well affords opportunity for closing up the inlet-holes, when necessary for repairs.

The overflow-weir consists of two openings, 2.2 metres wide by 1.6 metres high (7.2 feet by 5.2 feet), whose sides are placed 1.6 metres (5.25 feet) below the top of the dam.

The capacity of the reservoir is about 5,475,000,000 gallons, but the water-surface is never above half the height of the dam.

**The Lozoya Dam<sup>A</sup>** (Plate XXVII).—About the middle of this century the engineers of the Spanish government constructed a canal, known as that of Isabella II., for supplying Madrid with water from the Rio Lozoya. As the natural surface of this river is not sufficiently elevated for this purpose, it was raised by means of a masonry dam 32 metres (105 feet) high, and 72.5 metres (237.8 feet) long on top.

This dam consists of a wall of cut stone, 18.66 metres (61.2 feet) thick at the base, backed by rubble masonry, making the total thickness of the dam at its base 39 metres (128 feet). The back face is partially covered by a slope of gravel. The plan of the dam is straight.

No galleries pass through the wall; they are driven through the rocky banks of the reservoir. On the right bank there are two galleries; one, 6.82 metres (22.4 feet) below the

crown of the wall, serves to feed the canal, and the other, placed 9.1 metres (29.86 feet) below the same level, is the scouring-gallery, below which the reservoir is allowed to fill up with deposits.

On the left of the dam there is an overflow-weir cut in the rock, 8.4 metres (27.6 feet) wide, and 3.35 metres (11 feet) below the top of the wall.

**The Villar Dam\*** (Plate XXVIII).—The Villar reservoir on the river Lozoya was constructed in 1870–1878, to furnish an additional supply of water for Madrid. Mr. José Morer, chief engineer to the Spanish government, designed the reservoir and dam. The work was commenced in 1870 and completed in 1878.

The dam is about 170 feet high, and forms a reservoir having a capacity of about 4,400,000,000 gallons. It was built on a curved plan, the radius being 440 feet. The length on top is 546 feet, of which 197 feet are 8' 3" lower than the rest in order to form an overflow-weir. The maximum depth of the water below the level of the overflow-weir is 162 feet. Four lateral tunnels serve to discharge the excess of water in case of floods.

Two galleries run through the dam at a depth of 143 feet below the level of the overflow. Each gallery has an inlet of nineteen square feet, divided into two compartments, which are closed by sluices. These are operated by means of hydraulic power from a central tower, which is built on the inner side of the dam up to the level of the roadway.

With the exception of some cut stone on the crown, the whole dam was built of rubble masonry.

The total cost of the reservoir and dam was about \$390,000.

**The two Hajar dams†** (Plate XXIX.) were built in 1880 on the Martin River, at a distance of about nineteen miles from the city of Hajar, in order to form two large reservoirs for irrigation purposes. The first has a capacity of 6,000,000 cubic metres (1,584,846,000 gallons), supplied from a watershed of 238 square kilometres (92 square miles), and the capacity of the second is 11,000,000 cubic metres (2,905,551,000 gallons), its watershed containing 43 square kilometres (17 square miles).

Each reservoir has a masonry dam whose general dimensions are:

	Metres.	Feet.
Length on top, . . . . .	72	236.22
Height, . . . . .	43	141.07
Width at top, . . . . .	5	16.40
"    "    9 metres below top, . . . . .	5.2	17.06
"    "    base, . . . . .	44.8	146.98
	Square Metres.	Square Feet.
Area of profile, . . . . .	785.45	8,453.8

The back face of the profile is formed of a vertical line to a depth of 25 metres (82.02 feet), from which point it is continued by a circular curve, whose versed-sine at the base is 6.50 metres (21.33 feet). The front face is formed of a sloping line to a depth of 9 metres

\* Proc. Inst. C. E., vol. 71, page 379.

† "Bacini d'irrigazione," per G. Torricelli.

(29.53 feet), and then of a series of steps 2 metres (6.56 feet) high, and having an average width of 1.50 metres (4.92 feet). The outer corners of these steps are located in a circular arc, concave down-stream.

The maximum pressures on the masonry are:

	Kilos. per sq. centimetre.	Tons of 2000 lbs. per sq. foot.
Reservoir full, . . . . .	5	5.12
Reservoir empty, . . . . .	5.86	5.99

Both of the Hijar dams are founded on rock, and are built circular in plan, the radius being 64 metres (210 feet).

CHAPTER VIII.

FRENCH DAMS.\*

THE masonry dams built in France prior to the publication of M. de Sazilly's "Profile of Equal Resistance" in the "Annales des Ponts et Chaussées" for 1853 have less extravagant profiles than the old Spanish dams, but show, nevertheless, an utter absence of any rational theory regarding the proper method of designing a masonry dam. The difference of opinion held formerly by engineers as to which side of the profile ought to have the greater horizontal projection is shown in the following profiles, which we have taken from M. Krantz's "Study on Reservoir Walls:"†

- Lampy Dam (Plate XXX.), built in 1776-1782, on the canal of the South.
- Vioreau " (Plate XXXI.), " " 1833-1838, on the canal from Nantes to Brest.
- Bosmelea" (Plate XXXII.), \* " 1833-1838.
- Glomel " (Plate XXXIII.), " " 1833-1838, on the canal from Nantes to Brest.

The Gros-Bois Dam † (Plate XXXIV.) was constructed in 1830-1838 on the Brenne River to form a reservoir for feeding the canal of Bourgogne. Its principal dimensions are:

	Metres.	Feet.
Length on top, . . . . .	550.00	1804.6
Height above river-bed, . . . . .	22.30	73.2
"    "    foundation, . . . . .	28.30	92.9
Width at top, . . . . .	6.50	21.32
"    "    base, . . . . .	14.00	45.9

The overflow-weir is 10 metres (32.81 feet) long and 3 metres (9.84 feet) below the top of the wall.

The foundation upon which this dam was built consists of argillaceous rock possessing little hardness. When the wall had attained a height of only 4 metres (13.12 feet), a serious leak occurred through the foundation. Some lime was thrown near the crevices produced by the leak, but did not stop the loss of water. The reservoir had, therefore, to be emptied, and the crevices closed with masonry. In 1837 the tunnel which had been used as a waste-weir during the construction was closed, and the water allowed to fill the reservoir. When it had reached a depth of 17.45 metres (57.25 feet) its pressure produced a fissure at the intersection of the dam with the tower of the gate-house. It was noticed that the wall deflected a few centimetres down-stream under this pressure, and, upon the reservoir being emptied, returned almost to its original position. This fact proves that masonry has considerable elasticity.

---

\* The dams marked † are taken from "Bacini d'Irrigazione," per G. Torricelli. Roma, 1885.

† Paris, 1870.

In addition to this deflection, it was soon noticed that the wall had slid 0.045 metre (0.15 foot) down-stream. To arrest this motion the dam was reinforced in 1842 by seven counterforts, each being 4 metres (13.12 feet) thick on top and 11.30 metres (37.08 feet) at the base, projecting 8 metres (26.25 feet) from the front face. As fissures, however, were still noticed in the foundation, two more counterforts were built, and stopped all further trouble.

**The Tillot Dam**<sup>T</sup> is 13 metres (42.65 feet) high above the bed of the river, and 20 metres (65.62 feet) from the foundation. It has both faces vertical, and is 5.45 metres (17.88 feet) thick.

**The Chazilly Dam**<sup>T</sup> is situated in the Sabine Valley near Chazilly. It is 22.50 metres (73.80 feet) high, and 536 metres (1758.62 feet) long on top. Its thickness is 4.08 metres (13.39 feet) on top, and 16.20 metres (53.15 feet) at the base. It was built according to the profile of the Gros-Bois Dam (see Plate XXXIV.).

**The Zola Dam** (Plate XXXV.) was built about the year 1843 to form a reservoir for supplying the city of Aix (Provence) with water. It is named after M. Zola, the engineer who projected its construction but died before the plans were matured. The general dimensions of this dam are as follows:

	Metres.	Feet.
Length on top, . . . . .	62.5	205.00
“ at base, . . . . .	7.0	22.96
Height above foundation, . . . . .	36.5	119.76
Width at top, . . . . .	5.8	19.02
“ “ base, . . . . .	12.75	41.82
	Square Metres.	Square Feet.
Cross-section of wall, . . . . .	338.62	3644.6

The wall is surmounted by a parapet 1.20 metres (3.94 feet) high.

The Zola Dam is built of rubble masonry and made circular in plan, the radius at the crown being 158 feet. This dam is the only one known to the writer which is unable to resist the thrust of the water by its weight alone, and owes, therefore, its stability solely to its acting as a horizontal arch abutting against the sides of the valley. Assuming the specific gravity of the masonry as 2.2, we find that when the reservoir is full the resultant pressure at the base lies 3.5 metres (11.48 feet) outside the wall. At 9 metres (29.52 feet) height it would be 2.50 metres (8.20 feet) outside of the front face. At a height of 19 metres (62.32 feet) the resultant would be 2.75 metres (9.02 feet) inside of the wall, causing a maximum pressure on the masonry of 7.93 kilos. per square centimetre (8.12 tons of 2000 lbs. per square foot).

We have taken the above description from the memoir on the Verdon Dam by M. Tournadre, published in the “Annales des Ponts et Chaussées” for 1872 (1st semestre).

**The Dam of Settons** was built in 1855-58 to improve the navigation of the Yonne River. It is 21 metres (68.89 feet) high above the foundation, 271 metres (889.03 feet) long on the crest, and was originally 4.30 metres (14.10 feet) wide on top. The down-stream slope is on a batter of 1:33; the up-stream slope was originally vertical for a certain distance and then had two offsets of 1 metre each. In 1899 the thickness of

the dam was increased by 5.28 metres (17.31 feet) by building a guard-wall on the up-stream side of the dam for its whole height. Vertical wells of a horseshoe section were constructed in this guard-wall to intercept leakage through the masonry, and were connected with a drain.

**The Furens Dam** (Plate XXXVI).—This dam is also known as that of the “Gouffre d'Enfer,” the name of the gorge which it closes; also as the dam of Rochetaillée, the name of a village near its site; and as the dam of Saint-Etienne.

In 1858 the French government decided to construct an immense reservoir in the valley of the Furens River in order to protect the town of Saint-Etienne from inundations. The total cost of the work was estimated at \$298,300, of which amount the town of Saint-Etienne agreed to pay \$190,000 for the privilege of using part of the reservoir for storing water.

The mean annual flow of the Furens River is about 130 gallons per second, but in dry seasons it amounts to only 21 to 26 gallons per second. In 1849 the town of Saint-Etienne was inundated, owing to a great rise of the Furens River, caused by the bursting of a water-spout. According to the calculations of the French engineers the discharge of the Furens at that time must have amounted to about 34,600 gallons per second. The reservoir was designed to prevent inundations even in case of a similar maximum discharge. The drainage area of the Furens above the reservoir site is 9.65 square miles, and the mean annual rainfall 39.4 inches.

The engineers who designed and constructed the Furens Dam and reservoir are: M. Graëff, the Chief Engineer of the Département of the Loire; M. Delocre, who made the theoretical studies of the best form of profile; and M. Montgolfier, who had charge of the construction. M. Conte-Grandchamps assisted in the preliminary studies, but was promoted to another position before the masonry was commenced.

The greatest depth of water in the reservoir is 50 metres (164 feet), the total storage capacity being 1,600,000 cubic metres (422,625,000 gallons). Of this, however, the town of Saint-Etienne is only allowed to utilize 1,200,000 cubic metres (316,969,000 gallons), corresponding to a depth of water of 44.5 metres at the dam. The remaining 400,000 cubic metres (105,656,000) gallons of storage are reserved for preventing inundations.

The outlet from the reservoir consists of two cast-iron pipes, 0.40 metre (1.31 feet) in diameter, which pass through a lateral tunnel.

In constructing a dam exceeding in height all that were then existing, it is not astonishing that the engineers in charge of the work adopted out of precaution the low limit of pressure of  $6\frac{1}{2}$  kilos. per square centimetre (6.64 tons of 2000 lbs. per square foot), although they knew that some of the old Spanish dams sustain much greater stresses.

As the gorge which was to be closed was very narrow, it was decided to make the plan of the dam curvilinear, the radius being 252.50 metres (828.38 feet). The chord at the crown of the wall is 100 metres (328.07 feet), having a versed-sine of 5 metres (16.4 feet). This is the first French dam that was built curvilinear in plan.

The profile was based upon the type proposed by M. Delocre, which is shown in Plate II.; but curvilinear outlines were adopted in order to produce a more pleasing appearance. The thickness at the top of the dam was increased on account of the danger

from floating masses of ice; but at the bottom the width of the profile is slightly less than in Delocre's type.

The greatest height of the dam above the foundation is 56 metres (183.72 feet) on the down-stream side, but up-stream it is only 52 metres (170.6 feet).

Great pains were taken in all the details of construction. Before excavating the foundations a new, permanent channel was made for the Furens, and two lateral tunnels were also excavated to serve subsequently for the outlet-pipes. By these means, and a coffer-dam, the foundation was kept perfectly dry.

The rock on which the dam was built was mica schist. All loose or seamy portions were removed, and the whole foundation was sunk at least one metre into the rock, in order to prevent the dam from sliding. Where the surface of the rock was smooth, it was roughened either by exploding petards or else by coating it with Vassy cement into which building-stones were stuck.

The whole wall, including the facing, was built of rubble masonry, except the angle of the upper retreat, the parapets, and the corbels upon the outside facing. The stones were procured from the excavation for the foundation, from the new channel for the river, and from two neighboring quarries. The best stones were selected for the faces, where they showed a section of about  $1 \times 1.6$  feet and joints of  $\frac{3}{4}$  to  $1\frac{1}{2}$  inches. The stones varied in size from 2 to 7 cubic feet. In order to prevent unequal settling, the masonry was carried up about 5 feet high at a time over the whole wall. The top of each of these layers was left with as many projecting stones as possible, so as to bond it firmly with the next layer.

Cut stones 2.6 feet long and about 1.1 feet high were placed in the front face in quincunx order, 4.6 metres (15.09 feet) from centre to centre, and projecting 1.3 feet. On the back face there are three rows of iron rings to facilitate repairs.

The thickness of the dam at the highest level where the water is stored—44.5 metres (146 feet) above the bottom of the reservoir at the dam—is 6.37 metres (20.9 feet). Above this there is a guard-wall 5 metres (16 feet) high, having a thickness of 3.75 metres (12.3 feet) at the base and 3 metres (9.84 feet) at the top. This furnishes room for a carriage-way and two foot-paths. On the top of the guard wall there are two parapets which add 0.5 metre (1.64 feet) to the total height of the dam.

In order to prevent all leakage from the reservoir, the rock was stripped on the up-stream side of the dam for 60 to 80 feet, and all fissures that were discovered were carefully sealed with cement or masonry. Great pains were taken to make the joints between the dam and the rock on each side perfectly water-tight. A coating of 3 to 4 inches of cement was placed at the angles formed by the facing of the dam with the rock into which the dam was imbedded. It was originally intended to make all the joints of the up-stream face with Vassy cement, but this plan was discontinued after the dam had been built about 49 feet high, as the introduction of water into the reservoir proved that ordinary mortar would answer just as well.

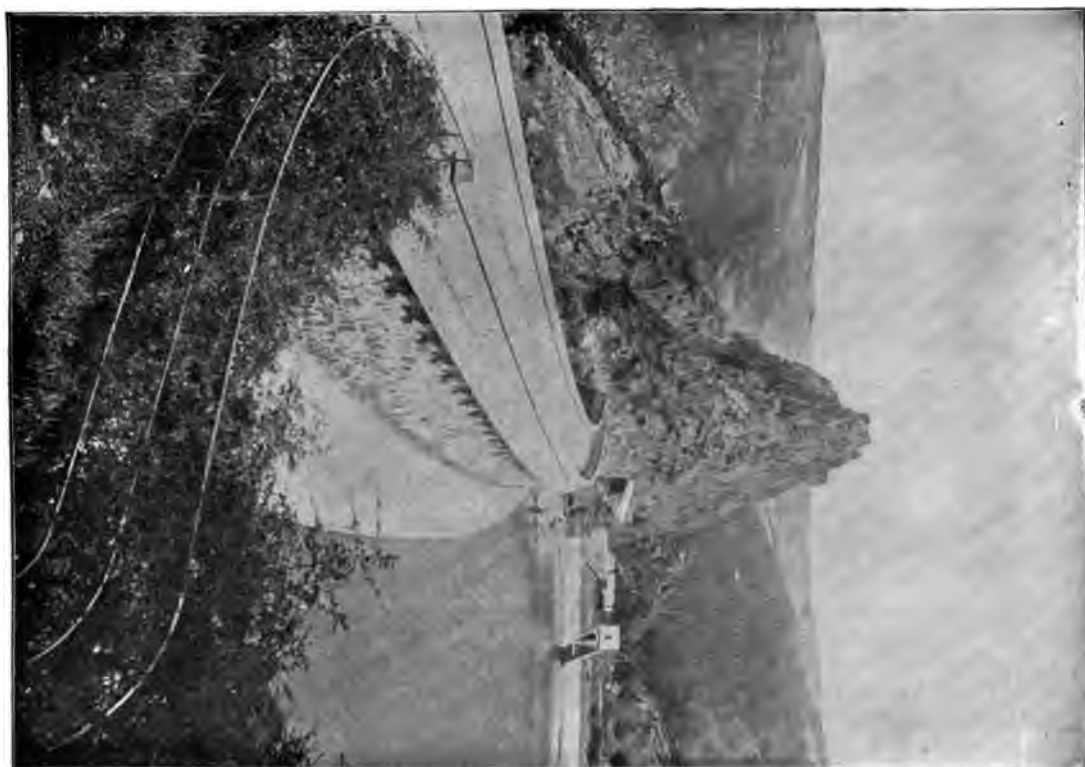
Owing to the high altitude of the Furens Dam, work on the reservoir could only be carried on from May 1st to October 1st of each year. The balance of the time, however, stones were quarried and hauled to convenient positions. The materials required in construction were distributed by means of a railway located on the top of the wall, and which was raised as the work advanced.



PLATE B.



FURENS DAM. (Front.)



FURENS DAM. (Back.)



The masonry of the dam was commenced in 1862 and completed in 1866. Four superintendents and twenty-five to thirty masons were employed, and laid on an average  $10\frac{1}{2}$  yards of masonry per day. The actual number of working days did not exceed 120 per annum. The total quantity of masonry in the dam was 52,300 cubic yards. The cost of impounding the water was 1.15 francs per cubic metre (0.0062 dollar per cubic foot).

The work of each season was allowed to harden thoroughly, and was then tested by allowing the water to flow into the reservoir and finally over the dam. In December, 1865, there were 46 metres (150.91 feet) of water in the reservoir; in March, 1866, 47 metres (154.19 feet). The only effect produced by this great water-pressure was a dampness on the front face, which was doubtless due to the porosity of the stone and mortar. A ditch was dug in the front of the dam and left open for four months in order to detect any leakage, but remained perfectly dry.

The description we have given above of the construction of the Furens Dam has been taken from the interesting memoirs published in the "Annales des Ponts et Chaussées" by MM. Græff and Delocre in 1866, and by M. Montgolfier in 1875.

In concluding the brief account we have given of this great work, we will state that the Furens Dam is the highest reservoir wall of the present time, and that it is the first masonry dam, which has been built in accordance with correct scientific principles. Its construction has been in every respect a great success, owing to the care taken in all the details of the building by the eminent engineers who directed the work.

**The Pas du Riot Dam**<sup>T</sup> is situated about 8200 feet from the Furens Dam, and was constructed in 1872-78 in order to form a reservoir of 1,300,000 cubic metres (343,383,000 gallons) capacity for the city of Saint-Etienne. The dam is 34.50 metres (113.19 feet) high, and is built on a curve in plan. Its profile was based upon that of the Furens Dam.

**The Ternay Dam** (Plate XXXVII).—This dam was built to prevent inundations by the Ternay River, and to supply the town of Annonay, in the province of the Ardèche, with water. The costs of the construction were borne by the state, town, and manufacturing interests.

The account we give of this work is taken from the interesting memoir published in the "Annales des Ponts et Chaussées" for 1875 by M. Bouvier, who designed and constructed the dam and reservoir under the general directions of M. Krantz, the Chief Engineer.

The vertical pressures in the masonry were not to exceed 7 kilos. per square centimetre (7.16 tons of 2000 lbs. per square foot); the coefficient of friction necessary to prevent sliding was limited to 0.76. The profile of the dam proper is surmounted by a rectangular portion forming a guard-wall 3.65 metres (11.97 feet) high and 4 metres (13.12 feet) thick. The dam without the guard-wall is 34.35 metres (112.67 feet) high and 4.8 metres (15.74 feet) thick on top.

The up-stream side of the profile is formed first by a vertical line 17.85 metres (58.56 feet) long, and then by two inclined lines, the first having a slope of 0.8 metre (2.62 feet) horizontal to 5.5 metres (18.04 feet) vertical; the second a slope of 3 metres (9.84 feet) to 11 metres (36.09 feet).

The down-stream side of the profile is formed by a circular curve whose radius is 45 metres (147.63 feet). The centre of the circle is 2.3 metres (7.54 feet) above the

crown of the dam. The curve terminates 9.3 metres (30.51 feet) above the base of the dam, the front face being completed by a tangent to the curve, whose horizontal projection is 7.1 metres (23.29 feet). The total thickness of the dam at its base is 27.2 metres (89.25 feet).

In his memoir describing the Ternay Dam, M. Bouvier advanced the formulæ we have given on page 12. The maximum pressure in this reservoir wall calculated by these formulæ amounts to 9 kilos. per square centimetre. M. Bouvier cites the experiments of M. Vicat to show that good hydraulic mortar may safely sustain pressures of 14.4 kilos. per square centimetre (14.73 tons of 2000 lbs. per square foot).

The Ternay Dam was built of rubble masonry, the stones used being granite. M. Bouvier gives:

The specific gravity of the granite, . . . . .	2.620
“ “ “ “ “ mortar, . . . . .	1.970
“ “ “ “ “ masonry, . . . . .	2.35

The proportion of the stone to mortar was as 6 to 4.

The wall was built on a curved plan, the radius being 400 metres (1312 feet).

The capacity of the reservoir formed by the Ternay Dam is 2,600,000 cubic metres (686,766,000 gallons), which is sufficient storage-room for retaining all the flood-waters of the river.

The dam and reservoir were built in 1865–1868.

**The Ban Dam**<sup>T</sup> (Plate XXXVIII.) was constructed in 1867–1870 to form a reservoir of 1,800,000 cubic metres (475,454,000 gallons) capacity, from which the city of St. Chamond draws its water-supply. This dam is 46.30 metres (151.86 feet) high. It was built on a curved plan. The profile was determined by the method employed for the Furens dam, but a higher limit of pressure was taken, namely, 8 kilos. per square centimetre (8.18 tons of 2000 lbs. per square foot). The dam is founded on rock, and composed of rubble masonry.

**The Verdon Dam** (Plate XXXIX.) was constructed in 1866–1870 to raise the level of the Verdon River sufficiently high to feed a canal which supplies the city of Aix (Provence) and other places with water. At the site selected for this work, near the village of Quinson, the width of the valley is only 115 to 130 feet, its rocky sides being almost vertical and about 160–200 feet high. The Verdon River has a fall of .003 foot in 1 foot, and its flow varies from 10 to 1200 cubic metres (2640–317,000 gallons) per second. To construct a dam across a river subject to great freshets, founding the wall on solid rock after excavating about 20 feet of gravel and boulders, was a difficult undertaking. For a detailed account of how the work was executed we must refer the reader to the interesting memoirs published by the Chief Engineer, M. de Tournadre, in the “Annales des Ponts et Chaussées” for 1872 (1st semestre), from which we take the following description. The general dimensions of the dam are:

	Metres.	Feet.
Length, . . . . .	40.00	131.23
Height above river-bed, . . . . .	12.25	40.19
“ “ foundation, . . . . .	18.00	59.06
Width at top, . . . . .	4.32	14.17
“ “ base, . . . . .	9.91	32.51
“ of foundation, . . . . .	15.00	49.21

The design of the dam was based on the assumption that it would be submerged 5 metres (16.4 feet) when the river had its maximum flow of 1200 cubic metres (317,000 gallons) per second. The profile had, therefore, to be made very strong, and special precautions taken in the details of the construction. A great freshet occurring soon after the completion of the work proved the correctness of the above assumption.

The foundation is built of concrete, and the dam proper of rubble with a cut-stone facing down-stream and a heavy cut-stone coping 0.75 metre (2.46 feet) thick. This coping forms six courses of voussoirs in plan, the stones being fastened together by iron clamps, and also secured to the up-stream side by iron dowels.

The mortar used in the masonry was composed of hydraulic lime of Theil and river sand.

The Verdom Dam is built circular in plan, the radius being 33.171 metres (108.83 feet) for the front face at the base. The foundation-mass of concrete, however, has a rectangular plan.

To resist the high fall of the water passing over the dam during freshets, a rip-rap of large boulders is placed in front of the wall.

**Bouzey Dam**\* (Plate XL.) was constructed in 1878 to 1881 near Epinal, France, to form a reservoir of about 1,875,000,000 U. S. gallons capacity for the "Canal de l'Est." The dam had a length of about 1700 feet on top. Its greatest height was 49 feet above the river-bed and 72 feet above the foundation. The dam was built straight in plan and had a profile which was calculated to be one of "equal resistance," each joint being assumed perpendicular to the resultant of all the forces acting on it. The profile adopted did not originally include the shaded portions shown in Plate XL.

The dam was founded on red sandstone, which was fissured and quite permeable. Considerable difficulty was experienced in the foundation-trench from springs. To prevent leakage under the dam a guard-wall, two metres thick, was built at the up-stream face from the solid rock to the river-bed, but the foundation of the dam itself was only excavated to fairly good bottom and not to the solid rock.

The dam was completed in 1880, but the reservoir was not filled until about a year later. When the water reached a level 33 feet below the top of the dam, springs of about 2 cubic feet per second appeared on the lower side of the wall. This leakage was partly due to two vertical fissures which had been made in the wall by changes of temperature before the reservoir was filled.

The water was raised very gradually in the reservoir. When it reached, on March 14, 1884, a level 10.5 feet below the top of the dam, a portion of the wall 444 feet long was shoved forward so as to form a curve, convex down-stream, having a versed sine of 1.1 feet. Four additional fissures appeared at the same time in the front face of the dam and increased the flow of the springs in front of the wall to about 8 cubic feet per second. No further motion took place in the dam although the water was kept at the level it had reached. The fissures in the wall opened in the winter and closed in summer on account of changes of temperature, their average width being about 0.28 inch.

---

\* Le Génie Civil for 1895 and Proc. Inst. C. E., vol. cxxv.

In 1885 the water was allowed to rise to the high-water level (1.97 feet below the top of the wall), and the reservoir was then emptied for inspection. It was found that the dam had separated from the guard-wall for a stretch of about 97 feet when it had been shoved forwards, and many fissures were discovered on the inner face. The masonry was repaired. To prevent the dam from sliding, an abutment was built in front of it and connected by an inclined wall which was toothed into the dam. A block of masonry was, also, built on the up-stream face to close the joint opened between the main dam and the guard-wall, and was surrounded by a bank of puddle, about 10 feet thick. The masonry added to the dam is shown by the shaded portions in Plate XL. Drains were placed in the masonry to carry off any water that might leak under the dam. The repairs mentioned were begun in 1888 and completed by September 14, 1889. The water was admitted to the reservoir again in November, 1889. On April 27, 1895, the water being at its highest level, about 594 feet of the central part of the dam was suddenly overturned at a plane about 33 feet below the top of the wall. The fracture was almost horizontal longitudinally. It was level transversely for about 12 feet and then dipped toward the outer face. The accident caused a great loss of life and property.

The failure of the Bouzey Dam is supposed to have been due to a greater tension at the up-stream face than the masonry could resist. This tension was probably increased by an upward water-pressure under the dam, which had not been founded on an impervious stratum.

**The Pont Dam<sup>r</sup>** (Plate XLI.) was built in 1883 on the Armaçon River, at a distance of  $2\frac{1}{2}$  miles from the city of Sémur. The dam is circular in plan, having a radius of 400 metres (1312.40 feet) and a versed-sine of 7.10 metres (23.30 feet). The length of the dam on top is 150.89 metres (495.12 feet).

The profile has a top width of 5 metres (16.4 feet), and is bounded as follows: on the back by a straight line having a batter of 0.05 metre per 1 metre of height; on the front, by a circular arc whose radius is 30 metres (98.43 feet) to a depth of 19 metres (62.34 feet) from the top, and which is continued by a tangent.

The height of the dam proper is 20 metres (65.62 feet), to which the foundation adds about 6 metres (19.69 feet). There are 7 counterforts on the front face, 5 metres (16.40 feet) wide by 3 metres (9.84 feet) thick, inclined parallel to the front face of the dam.

The dam was founded on rock and built of granite. When the reservoir was first filled, some water leaked through the dam, but the filtrations soon disappeared and the wall is now in excellent condition.

**The Chartrain or Tâche Dam\*** (Plate XLII.) was constructed in 1888-92 on the Tâche, an affluent of the river Renaison, which flows into the Loire to form a reservoir for supplying the city of Roanne with water.

The capacity of the reservoir is 4,500,000 cubic metres (158,897,000 cubic feet), of which, however, 500,000 cubic metres have to be reserved for storm-water.

The reservoir has a surface of 22 hectares (54.36 acres) and is supplied from a water-shed of 1400 hectares (52 square miles).

---

\* Vth International Congress on Inland Navigation. Report by M. Marius Bouvier on the Reservoirs in the South of France.

The Chartrain Dam is the most recent example of the construction of a dam in France built according to a scientific profile. Its design was based on the following principles:

1st. The lines of pressure, reservoir full or empty, must be kept within the centre third of the profile.

2d. The maxima pressures in the masonry or on the foundations are not to exceed 11 kilogrammes per square centimetre.

3d. There must be no possibility of the dam's sliding or shearing apart.

The plan of the dam was curved to a radius of 400 metres.

The Chartrain Dam was constructed of rubble masonry, made of porphyric rock and hydraulic mortar, weighing about 2400 kilogrammes per cubic metre (150 lbs. per cubic foot). The up-stream face was covered with a layer of artificial cement of slaked lime, 0.03 metre thick, made of equal parts of cement and sand, to 10 metres below the coping. In spite of this coating there was considerable leakage through the dam at first. It is, however, steadily diminishing.

The total cost of the Chartrain Reservoir was \$2,100,000 or 0.47 franc per cubic metre stored.

The Mouche Dam\* (Plate XLIII.), completed in 1890, was constructed across the Mouche River, an affluent of the Marne, near the village of Saint-Ciergues, to form a storage reservoir of 8,648,000 cubic metres (305,365,000 cubic feet) capacity for storing water for "the canal of the Haute-Marne." The surface of the reservoir at the level at which the water is to be stored is 97 hectares 46 ares (241.83 acres).

The Mouche Dam was designed by M. Carlier, Chief Engineer. It is 410.25 metres (1346 feet) long and is built straight in plan. The depth of the water in the reservoir above the meadow of the thalweg is 28.98 metres (95.08 feet).

As no good material for an earthen dam could be found near the site selected, it was decided to construct a masonry reservoir wall, although this involved an excavation of 7-12 metres below the surface of the ground to reach the marl-rock on which the dam was founded. 56 per cent of the total masonry of the dam was laid below the surface of the ground.

The profile of the dam (Plate XLIII.) was determined by the method recommended by M. Bouvier and improved by M. Guillemain. Besides fixing a limit for the pressure to be permitted in the masonry, the French engineers adopted also the condition, first insisted upon by Prof. Rankine, that the lines of pressure, reservoir full or empty, should be kept within the centre third of the profile. In the case of "reservoir full" this condition was carried out absolutely, but for "the reservoir empty" a slight deviation from the condition was permitted, especially as the reservoir will never be entirely emptied.

The probable weight of the masonry was determined by an experimental block containing 4 cubic metres. After diminishing for 25 days the weight of the block remained constant at 2150 kilos. per cubic metre (134.23 lbs. per cubic foot), which weight was adopted in the calculations.

---

\* Vth International Congress on Inland Navigation. Report by M. Gustave Cadart on the Reservoirs of the Department of the Haute-Marne.

The profile was determined by calculating the widths at horizontal sections two metres apart. Subsequently the pressures were determined on oblique sections from the foot of the up-stream facing and from other points.

The maximum pressure per square centimetre in the masonry is 6.58 kilogrammes (13,478 lbs. per square foot).

The top of the dam proper was made 3.50 metres wide and placed 2.05 metres above the highest water-level. As the dam was also to serve to carry a road 7 metres wide across the valley, the necessary additional width was obtained by constructing on the down-stream face of the dam a half viaduct 3.5 metres wide, consisting of 40 semi-circular arches of 8 metres span. The arches form 8 groups of 5 arches each, which are separated from each other by abutment-piers 2.80 metres thick. The ordinary piers have a thickness of only 1.80 metres at their lowest part.

The foundation trench was excavated at least one metre into solid rock, and considerably deeper for three anchor-walls.

The up-stream facing, formed of freestone coarsely prepared, was covered with three layers of burnt pitch and was afterwards whitewashed to prevent too great an absorption of heat.

The Dam of Avignonet<sup>B</sup> was constructed in 1899 to 1902 by the Society of Power and Light of Grenoble across the river Drac. The watershed of this river is mountainous and almost devoid of trees. This causes the discharge of the river to vary very much, the flow at low water being about 20-25 cubic metres (5,283-6,604 gallons) per second, while during floods the discharge amounts to over 1,000 cubic metres (264,140 gallons) per second. At the site of the dam the Drac flows through a very narrow gorge whose sides rise to a height of about 300 metres (984.2 feet). The gravel and stone carried by the stream during freshets have raised the original river-bed very much. As very deep trenches would have been required to reach bed-rock, and as it was essential to construct the foundations of the dam rapidly on account of the torrential nature of the Drac, it was decided not to go to bed-rock, but to found the dam on the compact gravel and fine sand in the river-bed which offered sufficient incompressibility and water-tightness.

The dam was built entirely of concrete as an overflow weir, according to the profile shown in Fig. 26. Its principal dimensions are:

	Metres.	Feet.
Length on the crest line.....	60.00	196.84
“ at the level of the river.....	45.00	147.63
Height.....	23.00	75.45
Thickness at top.....	4.75	15.58
“ “ base.....	23.90	78.40

The plan is curved to a radius of 200 metres (656.1 feet). Two cut-off walls, 4 metres high by 2.50 metres thick, were built into the gravel as shown in Fig. 26. An apron made of reinforced concrete protects the river-bed in front of the dam for a distance of about 20 metres. The dam has an outlet canal 70 metres long by 9 metres wide, the flow through which is controlled by a Stoney gate.

<sup>B</sup> The descriptions of dams marked B have been taken from a series of articles on masonry dams by H. Bellet, Civil Engineer, which appeared in "La Houille Blanche" for 1905 and 1906.



The Sioule Dam<sup>B</sup> was constructed in 1902-1904 across the Sioule River, near Queuille (Department of Puy de Dome), by The Gas Company of Clermont-Ferrand, to store water and

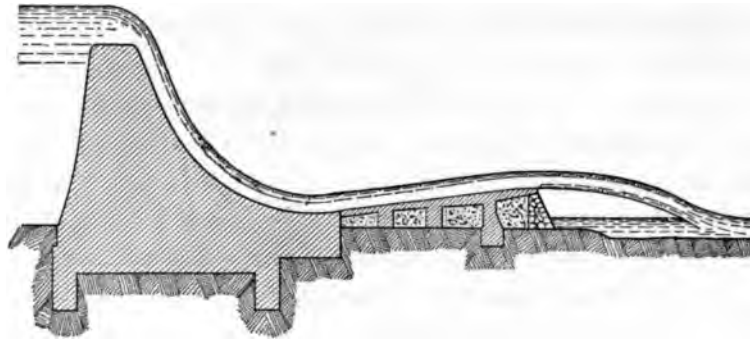


FIG. 26.—THE DAM OF AVIGNONET.

to obtain power. The dam was built according to the profile shown in Fig. 27, the principal dimensions being:

	Metres.	Feet.
Length on top. ....	120.00	393.71
“ at base. ....	60.00	196.84
Width at top. ....	5.00	16.40
“ “ base. ....	24.22	79.08
Maximum height. ....	30.00	98.42

The up-stream face is battered 1:10 from the top down for 11 metres and then 18 per cent for the remaining distance. The down-stream face is battered 0.72:1 at the base and

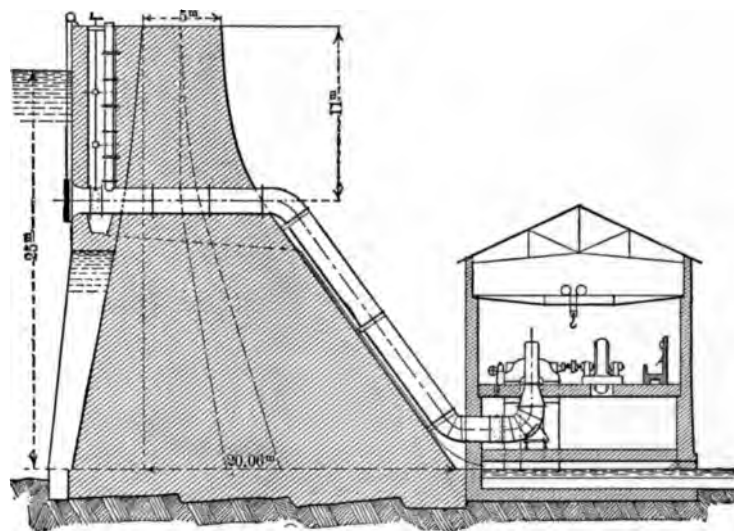


FIG. 27.—THE SIOULE DAM.

1:10 at the top, these batter-lines being joined by an arc of 15 metres radius. The plan of the dam is curved to a radius of 300 metres.

The dam has two overflow weirs built about parallel with the valley, one at each end.

The Miodeix Dam,<sup>B</sup> known also as the Dam of Sauviat (Department of Puy de Dome), was built in 1903 by the Power Company of Auvergne across le Miodeix stream, to store

water and furnish power. The maximum height of the dam above the foundations is 24.50 metres, the normal depth of water in the reservoir being 22 metres. It is constructed according to a triangular profile, the apex of the triangle being at the highest assumed water level, viz., 1 metre above the crest of the spillway. The tangents of the angles of inclination of the up-stream and down-stream faces are respectively 0.09 and 0.80, except at the top where the latter face is vertical, being joined with the inclined part of the face by an arc of 8 metres radius. The dam is 3 metres wide at the crest and 21 metres wide at the base. (See Plate XLIV.)

**The Turdine Dam<sup>B</sup>** was constructed in 1902-1904 across the Turdine stream to form a reservoir of 817,000 cubic metres capacity for the water-supply of the City of Tarare. The dam is 25 metres high, 4 metres wide at the top and 19.91 metres wide at the base. It is built according to a triangular profile. The up-stream face is inclined .05:1 for the first 10 metres and then 0.833 metre in the last 15 metres. The down-stream face is vertical for 1.65 metres and then has a batter of 0.80 metre per metre, the vertical and inclined parts of the face being joined by an arc of 15 metres radius. (Plate XLIV).

The plan of the dam is curved to a radius of 250 metres. The dam is 120 metres long in the centre line of the crest. The top of the spillway is 0.70 metre below the crest of the dam.

**The Dam of l'Echapre<sup>B</sup>** (Fig. 28) was built in 1894-98 across the stream l'Echapre, an affluent of the Ondenon, to form a storage reservoir for the water-supply of Firminy, Department of the Loire. The reservoir, which is located about 3 kilometres from Firminy, has a storage capacity of 950,000 cubic metres (about 251,000,000 gallons) and is supplied from a watershed of 1,440 hectares (5.56 square miles).

The principal dimensions of the dam are:

	Metres.	Feet.
Length on crest.....	165.00	541.34
“ at base.....	45.00	147.63
Top width.....	4.19	17.03
Width at base.....	27.00	88.58
Maximum height above foundation.....	37.00	121.39
“ depth of water.....	35.30	115.80

The plan of the dam is curved to a radius of 350 metres (1,148.2 feet). To obtain a suitable foundation the excavation had to be made to a depth of 7-13 metres.

The up-stream face is vertical for 30 metres, and the down-stream face has a batter of about 0.76 in 1.00. The masonry placed in the dam weighs 2,400 kilogrammes per cubic metre; the maximum pressure to which the masonry is subjected amounts to 11 kilogrammes per square centimetre (about 11 tons per square foot).

On top of the dam a roadway having on each side a sidewalk is constructed. In order to obtain the necessary width for the roadway and sidewalks, the thickness of the dam near the top is increased by corbeling out, the corbels being supported by masonry arches of 4 metres span, which are built in the down-stream face near the top. The arches are supported on pilasters built on the down-stream face, which are 1.20 metres wide and have a batter of 1:8. The total height of the arches is 11 metres and the maximum thickness is 0.90 metre. In order to make the dam as water-tight as possible its up-stream

face was given a coating of hydraulic mortar upon which a second coating of pure hydraulic cement was placed.

The reservoir has a waste-weir 31 metres (101.7 feet) long. The outlet-pipes are placed in the rock on the left side of the valley and do not pass through the dam.

This dam and the two following ones were designed and built by M. G. Reuss, Ingénieur des Ponts et Chaussées, under the general direction of M. Delestrac, the Engineer of the Department of the Loire. They have all similar profiles (Fig. 28). The arches and corbeling at the top of these dams reduces the amount of masonry required and is ornamental.

**The Cotatay Dam<sup>B</sup>** was built in 1900-04 on the Cotatay, an affluent of the Ondenon, to form a reservoir of 850,000 cubic metres capacity (about 225,000,000 gallons) for the water-supply of the City of Chambon-Feugerolles. The watershed supplying the reservoir contains 1,150 hectares (4.44 square miles). The dam has a maximum height of 44 metres (144.35 feet) above the foundation, the greatest depth of the water in the reservoir being 37 metres (121.39 feet). The crest of the dam is 1 metre above high water.

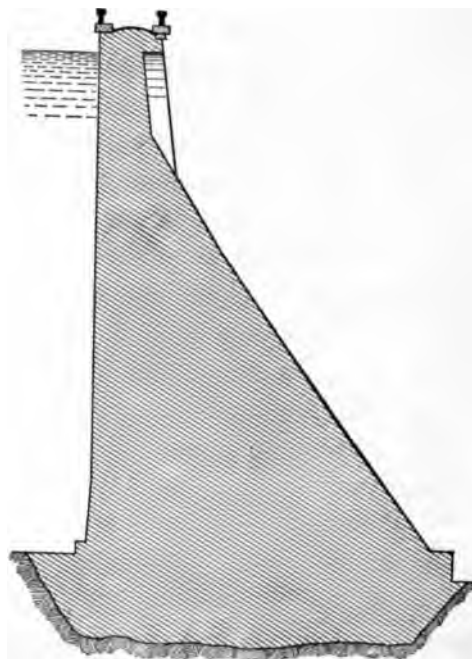


FIG. 28.—THE ECHAPRE DAM.

The top width of the dam is 4.60 metres and this is increased 0.50 metre by corbeling out, to obtain sufficient width for a roadway, which is constructed on top of the dam. The corbeling is supported by arches of 3 metres span, which are constructed on the down-stream face of the dam on a batter of 1:10. The plan of the dam is curved to a radius of 350 metres (1,148.2 feet). On the crest the length measures 155 metres (508.54 feet) and at the base 24 metres (78.73 feet).

The waste-weir is 42.75 metres (140.25 feet) long. Two lines of outlet pipes provided with stop-cocks are laid in a tunnel on the right bank. Water can be drawn from the reservoir at the level of the tunnel and at a level 10 metres higher.

**The Ondenon Dam<sup>B</sup>** was built in 1901-04 to form a reservoir for the water-supply of the town of La Ricamarie. The reservoir stores 400,000 cubic metres (about 106,000,000 gallons) and is supplied from a watershed of 530 hectares (2.03 square miles).

The dam has a maximum height of 37.50 metres (123.03 feet) above the foundation, the greatest depth of water in the reservoir being 32.60 metres (106.95 feet). The top of the dam is 0.50 metre above the high-water level. The dam is 4.70 metres wide at the top and 28.58 metres wide at the base. A roadway is constructed on top of the dam. Sufficient width for the purpose is obtained by corbeling out, the corbeling being supported by arches of 3 metres span, 0.60 metre deep. The pilasters of the arches are inclined 1.5.

The plan of the dam is curved to a radius of 300 metres (984.2 feet). The length of the dam is 128 metres (419.96 feet) at the crest and 12 metres (39.37 feet) at the base. The waste-weir is 28.75 metres (94.32 feet) long. The outlet-pipes are laid through the dam.

The Cher Dam \* (Fig. 29) is now (1907) in course of construction to form a reservoir of about 25,000,000 cubic metres (about 6,604,000,000 gallons) for supplying water to the City of Montluçon (Department of Allier) and to supply power for some hydro-electric works.

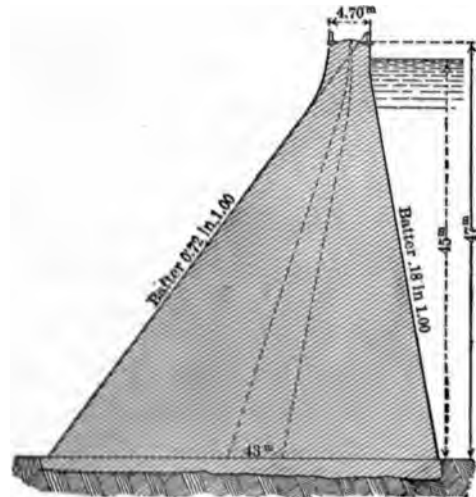


FIG. 29.—THE CHER DAM.

The dam will have a maximum height of about 48 metres (157.48 feet) and the greatest depth of water in the reservoir will be about 45 metres (147.63 feet). The top width will be 4.70 metres and the width at the base will be 43 metres (141.1 feet).

The plan of the dam will be curved to a radius of 200 metres (656.10 feet).

---

\* The author is indebted for the information given about the Cher dam to M. H. Bellet, C.E., of Lyons, France.

## CHAPTER IX.

## DAMS IN VARIOUS PARTS OF EUROPE.

**The Dam of Cagliari<sup>T</sup>** (Plate XLV.), situated on the Island of Sardinia at a distance of 13 miles from the city of Cagliari, was constructed in 1866 on the Corrongius River. The annual yield of this stream, derived from a watershed of 30,000 hectares (116 square miles), is estimated at 4,000,000 cubic metres (1,056,564,000 gallons).

The reservoir is 125 metres (412 feet) above the level of the sea, and has a capacity of 1,000,000 cubic metres (264,141,000 gallons). The principal dimensions of the dam are:

	Metres.	Feet.
Length on top, . . . . .	105.0	344.50
“ at base, . . . . .	50.0	164.00
Height, . . . . .	21.5	70.54
Width at top, . . . . .	5.0	16.40
“ “ base, . . . . .	16.0	52.50

This reservoir wall was founded on rock, and built of rubble masonry composed of granite stones and hydraulic mortar made of lime of Cagliari, and Pozzolona of Rome, mixed with well-washed granitic sand.

**The Dam of Gorzente\*** was constructed in 1880-1883 on the Gorzente River to form a storage reservoir of 2,250,000 cubic metres' (594,500,000 gallons') capacity for the water-supply of the City of Genoa, Italy, and to furnish water power for the generation of electricity. This storage basin, known as the reservoir of the Lavezze, has a surface of 26 hectares (64 acres) and is supplied from a watershed of 1,769 hectares (6.8 square miles).

The dam is built, according to the profile shown on Plate XLVI, in a narrow valley, its plan being curved up-stream. The principal dimensions of the dam are:

	Metres.	Feet.
Length at crest. . . . .	150.00	492.20
Maximum height above foundation. . . . .	37.00	121.40
Width at top. . . . .	7.00	22.97
“ “ base. . . . .	30-35	99-57

The dam is surmounted by a guard wall, 4 metres wide by 150 metres high.

The dam was founded entirely on rock and was built of the serpentine stone found in that locality and with lime of Casale mixed with serpentine sand.

As soon as the reservoir was filled the dam commenced to leak. In February 1885, before the waste channel was completed, a severe freshet raised the water in the reservoir more than 0.35 metre above the guard wall, causing some yielding of the dam. Borings made at different parts of the structure showed that the mortar had not set properly, and it is quite probable that the dam would have been ruptured had it not been that it was

---

\* Article by Mr. H. Bellet, Civil Engineer, in "La Houille Blanche" for October 1906.

constructed in a narrow valley with a curved plan. As a result of this experience it was decided to strengthen the dam by counterforts.

The outlet from the reservoir is not at the dam but at one side of the reservoir, where a special outlet chamber is constructed. To convey the water from the reservoir, which is located on the north slope of the Appenines, to Genoa, which lies on the south slope, a tunnel had to be driven through this mountain range. This tunnel, which begins at the outlet chamber, is 2300 metres (7,545 feet) long and has a slope of 0.5 millimetre per metre. The tunnel, which is under pressure, is lined with masonry and has for its waterway a horseshoe section composed of a trapezoid (1.65 metres high, 1.70 metres wide at the base and 1.90 metres wide at the top) and of a semicircle of 0.95 metre radius.

The tunnel aqueduct is continued by two lines of steel pipes of 0.75 metre inner diameter, which are under pressure. The tunnel and pipe-line together are known as the Aqueduct of Ferrari-Galliera.

The reservoir is provided with two waste-weirs. The first of these weirs, which is 7.50 metres long, is built adjoining the dam, its crest being 1.50 metres below the top of the dam. The second waste-weir is 40 metres long and has its crest 0.5 metre below the top of the dam.

A blow-off pipe controlled by suitable valves is embedded in the masonry 30 metres below the top of the dam and 14 metres below the aqueduct tunnel. It serves for scouring out the deposits that form in the reservoir.

**The Lagolungo Dam** (Plate XLVII, Fig. 2) was constructed, about 1883, immediately above the Lavezze reservoir to form a second storage basin for the City of Genoa, Italy. This reservoir has a capacity of 3,640,000 cubic metres (961,500,000 gallons). The dam has a maximum height of 40 metres at the up-stream toe and 44 metres at the down-stream toe. The dam is 5 metres wide at the top and was originally surmounted by a guard wall 2.50 metres wide by 2 metres high.

On the right side of the dam a waste-weir 22 metres long was constructed, with its crest at the level of the base of the guard wall. The dam is provided with four cast-iron outlet-pipes embedded in the masonry respectively 5, 10, 20, and 32.8 metres below the crest of the dam. These pipes have suitable valves on the down-stream side of the dam and discharge water from the reservoir either into the Lavezze Reservoir or into a conduit leading directly to the Ferrari-Galliera aqueduct.

After twenty years' experience with the reservoir it was decided, in 1903, to raise its water level 3 metres, increasing thereby the storage by 800,000 cubic metres. This was done by raising the waste-weir 3 metres and by replacing the original guard wall on top of the dam by a new one 4.25 metres high, 5 metres wide at the base, and 2.50 metres wide at the top. At the same time a second waste-weir, 18 metres long, was constructed with its crest at the same elevation as that of the first weir.

It was estimated that in case of freshets 0.60 metre of water might pass over the two waste-weirs. Flashboards were placed on top of the weirs to make it possible to retain the water at its greatest freshet height, increasing thereby the capacity of the reservoir by an additional 200,000 cubic metres.

**The Dam of the Lavignina** was constructed to form a compensating reservoir of 1,000,000,000 cubic metres capacity to supply the riparian owners along the lower Gorzente with water.

The dam has a maximum height of 21.70 metres and is built according to a profile similar to those of the two dams described above.

**The Gileppe Dam\*** (Plate XLVIII).—The reservoir in the valley of the Gileppe was constructed by the Belgian government to regulate the flow of this stream, and to furnish the important cloth manufactories at Verviers with a large supply of pure water.

M. Bidaut, the Chief Engineer who designed the Gileppe Dam and reservoir, commenced the preliminary studies in 1857, but, owing to various delays, his plans were not submitted to the ministry until 1868.

According to careful observations, the watershed of the Gileppe, containing 4000 hectares (9880 acres), yields from 20–23 million cubic metres (5,283,000,000, to 6,075,000,000 gallons) of water per annum. It was decided to construct a reservoir having a surface of 80 hectares (198 acres) and capable of storing 12 million cubic metres (3,170,000,000 gallons), by building a dam 45 metres high (147.6 feet) across the valley of the Gileppe. The same storage capacity might have been obtained by constructing four different basins having dams only 27 metres (88.6 feet) high, but the plan of one reservoir with a high dam was found to be more economical.

The Gileppe Dam was built curvilinear in plan, the radius being 500 metres (1640 feet). Its greatest height is 47 metres (154.2 feet). The length on top of the wall is 235 metres (771 feet), at the base 82 metres (269 feet). The breadth of the wall is 15 metres (49.22 feet) on top and 65.82 metres (216.5 feet) at the base. The foundations were carried 1 metre into the rock. With the exception of a band of cut stones at the top and bottom of the front face, and at the angles where the batters change, the whole wall was constructed of rubble masonry, the total quantity amounting to 325,000 cubic yards. Although this massive dam was built with the utmost care, it was completed in six years. The work on the masonry progressed as follows:

	Cubic Yards of Masonry.
1870, . . . . .	19,400
1871, . . . . .	78,500
1872, . . . . .	59,300
1873, . . . . .	68,900
1874, . . . . .	46,500
1875, . . . . .	52,400
	325,000

The average yearly work of over 54,000 cubic yards has probably never been surpassed in the construction of any other single structure. It was accomplished by 80 to 100 masons under the direction of 8 to 10 foremen. The work per man amounted daily to from 2.6 to 3.2 cubic yards.

The sandstone or limestone used in the wall came from neighboring quarries, which were located at least 50 metres (164 feet) from the site of the wall and above the level of its crown. Two narrow-gauge railways served to transport the building materials to the dam.

\* Die Thalsperre der Gileppe bei Verviers. Von Ingenieur F. Kuhn. Published in "Der Civilingenieur," 1879.

Before commencing the foundations two subterranean channels were excavated, one on each side of the dam, by means of which the Gileppe was turned from its bed during the construction. These channels served subsequently as ways for the cast-iron outlet-pipes, by means of which water is drawn from two wells, each 2.8 metres (9.2 feet) diameter, placed in the reservoir.

Two overflow-weirs, 2 metres (6.58 feet) below the crown of the dam and 25 metres (82 feet) wide, situated one at each extremity, serve for letting the flood-waters escape. The carriage-road on top of the dam passes over the overflow-weir, ascending to the crown of the dam by grades of 1 in 7.

The leakage through the dam when the reservoir was first filled amounted to about 5300 gallons per day. This was probably due to the fact that the wall had not been exposed to the action of water during construction, as was done with the Furens Dam.

The leakage soon diminished; but even four years after the reservoir had been in use, a certain amount of moisture was perceptible on the down-stream face.

The total cost of the Gileppe Dam and reservoir was \$874,000, amounting to 0.2 cent per cubic foot of storage room.

The profile of the Gileppe Dam has been severely criticised for its extraordinary top width of 15 metres (49.22 feet), and for involving about 75 per cent of useless masonry. It stands, indeed, in striking contrast to the scientific designs adopted for the dams of Furens, Ternay, and Ban, and resembles more nearly the early Spanish dams. To justify the great top width of the profile, it has been stated by the Belgian engineers that the dam was designed with a view of being raised to a greater height when more storage might be required. However, the main reason seems to have been a great timidity on the part of the Belgian engineers, who were fully impressed with the great body of water they were going to store (six times the contents of the Furens reservoir), and the calamity the failure of the dam would cause.

M. Bidaut, the Chief Engineer, went with his calculations of the stability of the dam even to the extreme of supposing water to percolate through the wall to such an extent that the specific gravity of the masonry would be reduced from 2.3 to 1.3.

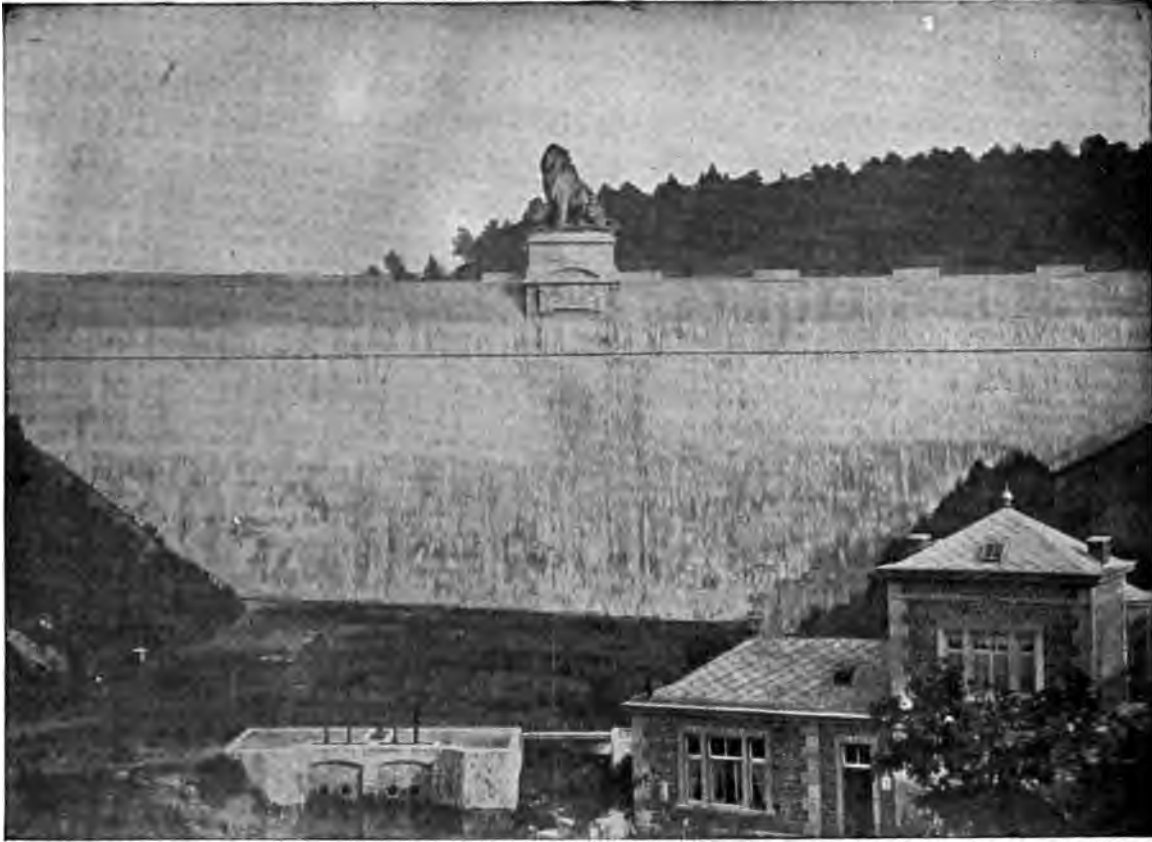
**The Vyrnwy Dam**, England, Plate XLIX, was constructed in 1882-90 to form a large storage reservoir on the Vyrnwy River for the water-supply of the city of Liverpool. This artificial lake, which is situated at a distance of  $67\frac{1}{2}$  miles from the old reservoirs at Prescott, covers 1115 acres, at an elevation of 825 feet above the level of the sea.

The Vyrnwy Dam is 1350 feet long on top, the plan being straight. Its maximum height above the foundation is 136 feet. The profile adopted differs from most of the others described in this book in not being designed simply to resist the water-pressure, but to form also a waste-weir. The front face of the wall is made, therefore, to conform to the curve described by the water in overflowing, and to deflect it into the basin in front of the dam.

The foundation was laid on a clay slate rock, which is frequently interspersed with hard volcanic ash, and ranges from a close-grained grit of dark bluish-gray color to a fine slate texture. The strata dip up-stream, the different beds varying in thickness and hardness. Great care was taken in preparing this rock for the foundation. All projecting portions or any parts which seemed in the least doubtful were removed.



PLATE C.



GILEPPE DAM. (Front View.)

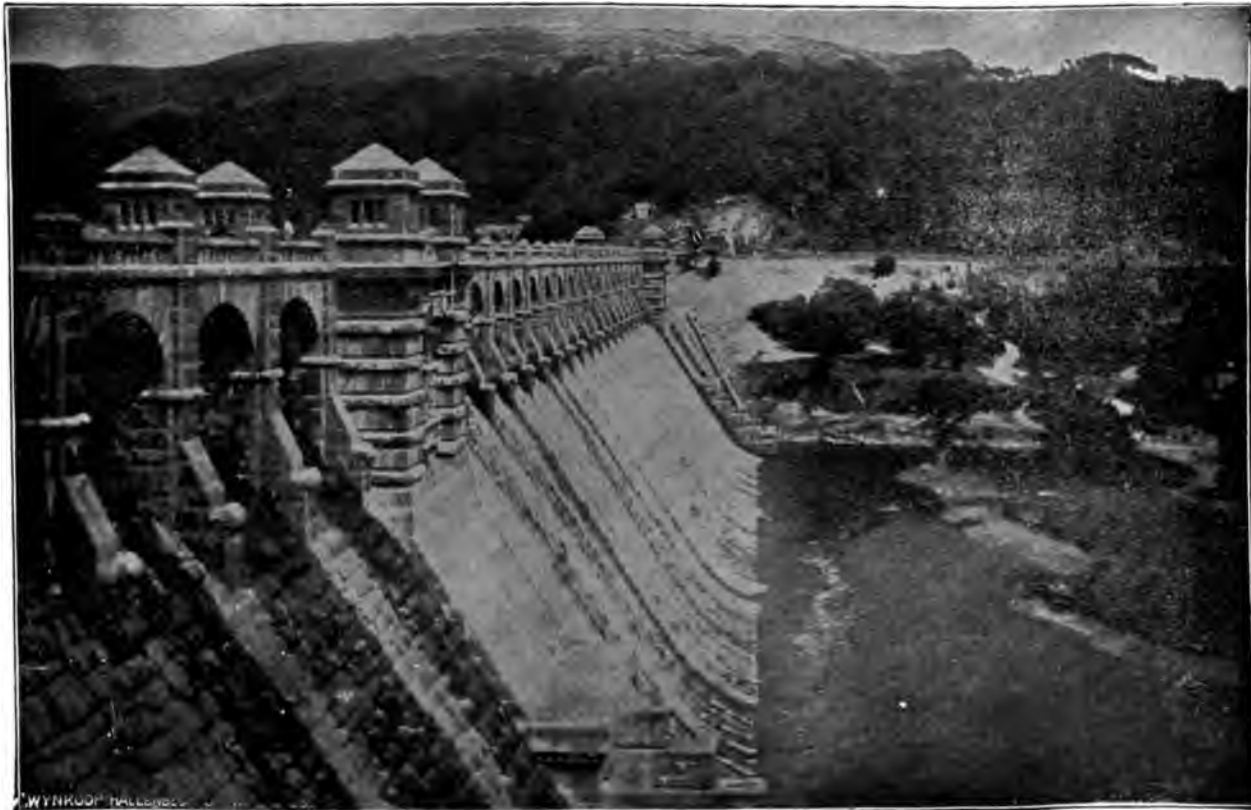


GILEPPE DAM. (Side View.)





VYRNWY DAM.



VYRNWY DAM.



The dam was built of "Cyclopean rubble," which, owing to the great precautions taken, has much greater strength than ordinary rubble. The stone used is of a similar kind to that excavated in the foundation. It weighs 2.06 tons per cubic yard, its specific gravity being 2.721. The quarry from which the stones were obtained is situated at a distance of about one mile from the dam, and the stones were transported to the work by means of a double-track railway of 3 feet gauge.

The blocks were shaped roughly at the quarry. All thin, projecting pieces were cut off, and a flat but rough surface was prepared for the lower bed. The best stones were reserved for the faces, and were cut to templates, their upper and lower beds being dressed parallel and their sides made vertical. An idea of the average size of the stones employed may be obtained from the following statement of the stones discharged from the quarry for the year ending October 18, 1885:

Stones under 2 tons. . . . .	45.99 per cent.
Stones 2 to 4 tons. . . . .	20.86 "
Stones 4 to 8 tons. . . . .	33.15 "

Before being placed in the wall, all stones, whatever their size, were scrubbed and subjected to jets of water under a pressure of 140 feet.

In the beginning of the work the sand for mortar and the gravel for concrete were obtained from the river-bed. As this material, however, contained a large amount of clay and oxide of iron, it was thoroughly washed in revolving cylinders having internal vanes arranged so as to lift and drop the sand and gravel. For the lower part of the dam the mortar was composed of two parts of this washed sand and one part of Portland cement. As the natural gravel after being cleansed still contained a large percentage of sand, the concrete was made of two parts of this gravel mixed with one part of Portland cement without any further addition of sand.

Experiments made in 1883 showed that by pulverizing the quarry-refuse-rock and mixing it with the natural sand in the proportion of two parts of the former to one of the latter, a stronger mortar was produced by using two parts of this mixture to one part of Portland cement than was obtained when only the natural sand was employed in a similar proportion. After 1883 all the sand used was obtained in this manner, and it was found that the mortar produced from this mixture of sand had not only great strength, but also the very desirable quality of "an absence of shortness."

All the mortar used in the dam was made with Portland cement which was required to stand the following test for tensile strength: Of six briquettes, 8 days after being moulded, kept in water from the second to the seventh day, at least one had to sustain without fracture a tensile strain of 5 cwts. per square inch for one hour. The average strength of about 9000 briquettes tested in this manner was  $6\frac{1}{2}$  cwts. As regards fineness, it was specified that not over 10 per cent of the cement should be retained by a sieve having 60 brass wires to the lineal inch and weighing  $3\frac{1}{4}$  ounces per square foot.

It is well known that Portland cement of great strength may be obtained by using a large amount of chalk in its manufacture; but unless the cement is burnt thoroughly it will contain lime in an uncombined state, which when mixed with water slakes and

swells, contracting subsequently when the surrounding cement is just acquiring its hardness. Most Portland cements have some free lime, which, however, owing to its great affinity for moisture, may be converted into a harmless hydrate of lime by merely exposing the cement to the air. To effect this purpose all the cement used for the Vymwy Dam was spread, 6 inches thick, on platforms placed one below the other and 18 inches apart. Each platform consisted of loose boards which could be turned so as to drop the cement on the platform below. In this manner it was exposed seven times, being left on each platform one or two days, depending upon the dampness of the air. Owing to the precautions taken with the cement, no "hair-cracks" have appeared in the mortar used in the work.

The sand and cement were mixed dry in accurate proportions in revolving cylinders having internal vanes. Before passing out they were wetted uniformly by a water-spray. Originally the sand and cement were mixed 2 to 1, but later this proportion was changed to  $2\frac{1}{2}$  to 1.

The dam was built in the following manner: A level bed was first prepared on the rock, or on the masonry already laid, and was covered with a 2-inch layer of cement mortar, which was beaten to free it of air. A large stone was then lowered into position by a steam-crane, and was beaten down into the mortar by blows from heavy hand-malls. Other large stones were similarly placed, but so as not to touch each other. The spaces left between them were filled either with rubble made with small stones or with concrete which was thrust into the narrow spaces with blunt swords. The work within the reach of each crane was brought up 6 to 8 feet before the crane was moved. In each course the large stones were laid so as to bond with those in the course below. There are no horizontal joints passing through the wall, as the top of each course was left with projecting stones and hollows, which permitted it to be well bonded with the next course. To make the back face thoroughly water-tight, the vertical joints for several feet from the face were filled with mortar alone into which broken stone was forced.

Seven steam-cranes were used in the construction of the dam, each with its driver and 18 men laying on an average 40 cubic yards per day. The specific gravity of the masonry, based upon the actual weights of the materials used up to the end of 1885, was found to be 2.577. Numerous tests made with 9-inch cubes of concrete taken directly from the wagons as it went into the work showed the crushing strength of the concrete when one year old to be about 187 tons per square foot.

The area of the typical section shown in Plate LI. is 8972 square feet. When the reservoir is empty and the front face of the wall is subjected to a normal wind-pressure of 40 lbs. per square foot, the maximum stress on the masonry amounts to 8.7 tons per square foot. When the reservoir is full and the wind is blowing down the valley with a force of 60 lbs. per square foot, the maximum stress on the masonry is 6.36 tons, and the angle made by the resultant pressure with a vertical line is  $16^{\circ} 39'$ .

To prevent the possibility of a greater upward water-pressure under the dam, in case the foundation should prove to be pervious and the dam impervious, than that due to the 47 feet of water in front of the wall, a complete system of drains was constructed in the foundation. Where the bed-rock has the lowest elevation there are twenty-six such drains in a length of 198 feet of the wall. They are 9 to 12 inches square, and lie on the

rock near such places where leakage is apt to occur. The drains are kept 25 feet from the front face and 30 feet from the back face, and connect with a central tunnel, 4 feet high by 2' 6" wide, which traverses the foundation longitudinally at an elevation of 46.5 feet above the base of the typical cross-section. By means of a cross-tunnel leading downstream any water that may filter into the foundation above the elevation of the drains is discharged at the front face of the dam.

The description we have given above has been taken from the "Report of Mr. George F. Deacon, C. E., as to the Vyrnwy Masonry Dam," made to the Water Committee of the city of Liverpool in December, 1885.

**The Thirlmere Dam** was built in 1886-1893 at Thirlmere Lake, about 5 miles from Theswick, to form a reservoir for the water-supply of Manchester, England. Mr. George H. Hill was the engineer in charge of the work.

The dam is built in plan on a reverse curve, in order to follow the ledge rock with a view of reducing the depth of the foundation-trench. The dam has a maximum height of about 62 feet. At the top it has a width of 18.5 feet, the width being increased to 51.75 feet at a depth of 58 feet below the crest. The up-stream face has a batter of 1:8 and the down-stream face is curved to a radius of 100 feet. The crest of the dam is 6.2 feet above high water in the reservoir.

**German Dams.**—A number of masonry dams, backed on the up-stream side for about half the height by earthen embankment, have been constructed in Germany. This type of dam (Fig. 30) was designed by Professor Intze of Aachen. The embankment on the up-stream face is made of clay, gravel, and stones, and is paved. Its slope is 2:1. The object of this embankment is to make the dam water-tight at its base. Objections have been raised to the use of such embankments on the grounds, *First*, that the embankment covers an important part of the dam, making it impossible to inspect it; and *Second*, that the water may filter down between the dam and the embankment along its vertical face, in which case the embankment may become saturated and cause greater pressures against the dam than those which would result from the water pressure.

The following table, which is taken from an article on masonry dams by H. Bellet, Civil Engineer, which appeared in "La Houille Blanche" for June 1906, gives some of the dams that have been constructed according to this type:

GERMAN DAMS.

Name.	Location.	Height.	
		Metres.	Feet.
Salbach.....	Ronsdorf.....	23.90	
Lingese.....	Marienheide.....	24.50	
Eschbach.....	Römscheid.....	25.00	
Bever.....	Hükeswagen.....	25.00	
Fuelbecker.....	Altena.....	27.00	
Jubach.....	Meinerzhagen.....	27.80	
Glörsbach.....	Breckerfeld.....	32.00	
Hasperbach.....	Haspe.....	33.70	
Herbringhauser.....	Lüdringhausen.....	34.00	
Oester.....	Plettenberg.....	36.00	
Henner.....	Meschede.....	37.90	
Ennepe.....	Altenvörde.....	41.00	
Sengbach.....	Sölingen.....	43.00	
Queis.....	Silesia.....	45.00	
Ürft.....	Gemund.....	58.00	

**The Remscheid Dam\*** was built in 1889 to 1892 across the Eschbach Valley, to form a storage reservoir of 35,310,500 cubic feet capacity for the water-supply of Remscheid, Germany. The plans for the work were made by Prof. O. Intze. The dam is about 82 feet high, and is 13 feet  $1\frac{1}{2}$  inches wide on top and 49 feet  $2\frac{1}{2}$  inches at the base. It is curved in plan to a radius of 410 feet. The profile is designed to keep the lines of resistance within its centre third, reservoir full or empty.

The dam contains about 617,935 cubic feet of masonry, weighing about 4045 pounds per cubic yard. The stone used is a hard Linneite slate, quarried near the dam. It has a specific gravity of 2.7. About 38 per cent of the masonry consists of mortar, composed of 1 part lime,  $1\frac{1}{2}$  parts powdered Trass, and 1 part sand. This mortar sets much more slowly than one made with cement, and can be left mixed a whole day without injury. To make the dam as water-tight as possible, the back face was plastered first with cement mortar and then with asphalt. A brick wall ( $1\frac{1}{2}$  to  $2\frac{1}{2}$  bricks thick) was laid on top of the layer of asphalt, cement mortar being used. The dam has proved to be perfectly water-tight.

**The Einsiedel Dam†** was built in 1890 to 1894 to form a reservoir storing about 95,000,000 gallons for the water-supply of the city of Chemnitz, Germany. The dam is 590 feet long on top. Its greatest height is 65.6 feet above the natural surface and about 92 feet above the foundation. The dam is 13.1 feet wide on top and 65.5 feet wide at the lowest foundation. In plan the wall is curved to a radius of about 1310 feet.

The dam was built of "cyclopean rubble," the stone used being hornblende slate, quartzite slate, and clay slate. The mortar consisted of 1 part cement,  $\frac{1}{2}$  part fat lime, and 5 parts washed sand. About 31,600 cubic yards of masonry were laid in the dam, about one third of the contents being mortar.

The waste-weir is 82 feet long. Water can be drawn from the reservoir through three gates placed at different elevations in the side of a gate-house built of concrete on the up-stream face of the dam. The outlet- and waste-pipes pass through a culvert in the dam, the inner end of which is closed by a masonry bulkhead. Stop-cocks placed in a vault at the lower face of the wall serve to control the flow through the pipes.

**The Urft Dam‡** (Fig. 30), the highest structure of its kind in Europe, was constructed in 1901 to 1904 across the river Urft, near the City of Aachen, in Rhenish Prussia, Germany. It forms a reservoir of about 12,000,000,000 gallons capacity, which regulates the flow of the river and furnishes power and water for irrigation. The dam has a maximum height of 58 metres (190.29 feet) above the foundation, the greatest depth of the water at the dam being 50.5 metres (165.68 feet). The dam was built according to the type of Professor Intze, mentioned above, a paved earthen embankment with a slope of 2:1 being placed against the up-stream face of the dam for half its height. The plan of the dam is curved to a radius of 200 metres (656.1 feet), the length of the structure on the crest being 226 metres (741.39 feet). A waste-weir, 90 metres (295.27 feet) long,

\* *Engineering News* of 1906.

† *Engineering Record* of 1894.

‡ *Engineering News*, July 16, 1903, "Zeitschrift des Vereins Deutscher Ingenieure," 1903, and "La Houille Blanche," Grenoble, France, June 1906.



prolongs the dam at its north end. The top of this weir is 1.50 metres below the crest of the dam. Instead of being built in a straight line, the crest of the waste-weir is scalloped or wave-shaped in plan, with panels 20-25 feet wide, separated by buttresses. Several of these panels have gates which can be used to increase the discharging capacity of the weir. The dam is 5.5 metres (18.04 feet) wide on top and 50.5 metres (165.68 feet) wide at the base, the latter width being equal to the maximum depth of water in the reservoir at the dam. The crest is 1 metre above the highest water level.

The dam is founded on mica schist and slate, the foundation-trench being excavated to a depth of about 6 metres. The body of the dam was built of argillaceous slate, laid in courses inclined against the line of pressure. On the up-stream side the dam was

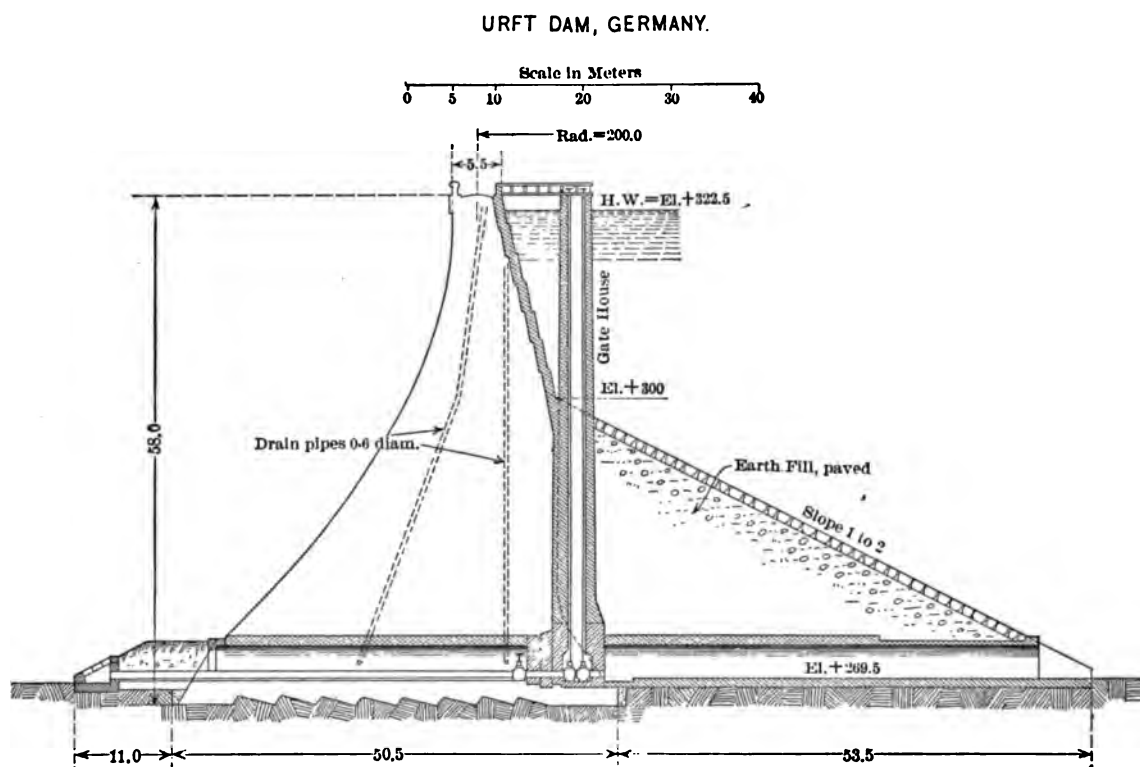


FIG. 32.

faced with trap-rock for a depth of 3 feet, the stones being stepped on the battered portion of the face. Between the body of the dam and the face wall a 1-inch layer of cement, coated with asphalt, was placed. This was done to insure water-tightness, but, to provide for carrying off any water that might leak into the dam, two rows of drain-pipes (2½-inch clay pipes) were placed vertically in the masonry near the up-stream face, the pipes in each row being about 8 feet apart. The pipes of each row are connected to a 6-inch header leading to two drain-tunnels, which are constructed through the dam near its centre at its lowest level. Each of these drains is closed by a gate-chamber at the up-stream face of the dam. They are continued as masonry conduits through the earth embankment. From each gate-chamber a tower rises in which the stems of the gates are placed.

In each of the drainage-tunnels a low-off pipe is laid. These pipes extend into the gate chambers, where two gate-valves, operated from the top of the towers,

are provided for each pipe. In addition to this each of the pipes has a third gate, placed just below the gate-chamber, which can be reached through the drain-tunnel.

The wasteway is in natural rock, which is cut roughly into steps, about 5 feet high, in order to break the force of the water. These steps are covered with concrete to resist the erosion of the water.

At the site of the dam the stream makes a loop. During the construction of the dam a temporary earthen dam was built across the stream some distance above the site of the masonry dam, at a point where only a narrow ridge of rock separated the site of the temporary dam from that of the permanent dam. A tunnel was driven through this ridge, to divert the river during the construction to a point below the site of the masonry dam. This tunnel, which passes under the spillway, was provided with a gate and serves now as a permanent drain-tunnel.

An outlet-tunnel, 9,200 feet long, was driven about a mile north of the dam. It supplies water under a head of 360 feet to a power-house in an adjacent valley, where 8 turbines, of 1,250 H.P. each, drive electric generators for transmission to neighboring towns.

The works were designed by Prof. Otto Intze of Aachen, under whose direction they have been constructed.

**The Komotau Dam\*** (Plate XLVII, Fig. 1), known also as the Kaiser Franz Joseph Dam, was constructed during the years 1901-1904 to form a reservoir of 700,000 cubic metres (184,898,700 gallons) for the water-supply of the City of Komotau, Bohemia. It is the highest dam in the Austrian Empire.

The principal dimensions of the dam are as follows:

	Metres.	Feet.
Maximum height above foundation .....	42.5	139.4
“ “ “ surface .....	35.5	116.5
“ depth of water.....	34.0	111.5
“ “ “ foundation.....	16.0	52.5
Top width.....	4.0	13.1
Width at base.....	30.0	98.4
Length at crest .....	155.0	508.5
“ “ bottom.....	52.0	170.6
Volume of masonry.....	41,000 cubic metres	
Specific gravity of masonry.....	2.4	

The plan of the dam is curved to a radius of 250 metres (820.1 feet).

The dam is founded on gneiss rock and constructed of cyclopean masonry made of blocks of gneiss and Portland-cement concrete, except the ornamental work at the top of the dam, which is made of granite dimension stone.

The maximum pressures in the masonry, for reservoir full and reservoir empty, are respectively 6.12 and 5.94 kilogrammes per square centimetre (about 6 tons per square foot).

To insure water-tightness the up-stream face was given two layers of a mixture of tar and natural asphalt, which were protected towards the reservoir by a covering of con-

\* See Oesterreichische Wochenschrift für den Oeffentlichen Baudienst, January 16, 1904.

crete, which was dove-tailed to the main body of the dam. To get rid of any water which might seep into the dam in spite of this precaution, drainage-pipes of .08 metre diameter were placed vertically, with open joints, in small shafts in the masonry, 2 metres apart and 1 metre from the up-stream face. These pipes were connected at the bottom by larger pipes which discharge the water collected in the masonry into a drainage-gallery.

An outlet-tower is constructed on the up-stream face of the dam. It contains two stand-pipes, which admit water from the reservoir at different levels through openings controlled by valves operated from the top. The stand-pipes are connected to horizontal pipes laid in a gallery which is constructed in the dam.

A waste-weir, 21 metres long, discharges all flood-waters into a wasteway constructed around the reservoir.

The Komotau Reservoir was projected, as early as 1874, by Professor Harlacher of Prague, but twenty-seven years elapsed before the work was executed. The works were planned and constructed under the direction of Mr. Ernst Landisch, Civil Engineer and Architect, who has charge of the public works of Komotau. Dr. Otto Lueger of Stuttgart acted as Consulting Engineer.

## CHAPTER X.

## DAMS IN ALGIERS.

**The Habra Dam** (Plate L.).—The great results obtained by irrigation in Spain induced the French government to encourage similar improvements in Algiers. How much the condition of agriculture in that country depends upon a good supply of water may be judged from the fact that the average rainfall is only about 15 inches, of which quantity, moreover, only one thirty-seventh reaches the streams. The rain is very unequally distributed over the different seasons, and the idea, therefore, naturally suggests itself to store the surplus water of the rainy months for the time of drouth.

Among the important reservoirs constructed by the French in Algiers for this purpose, the largest was that of the Habra River. Although the watershed of this stream contains one million hectares (3859 square miles), yet, owing to the climatic conditions stated above, the annual yield of water amounts to only 108,000,000 cubic metres (28,521,000,000 gallons). The variableness of the flow of the Habra River will be seen from the following figures:

	Litres.	Gallons.
Flow per second in summer, . . . . .	500	132
“ “ “ “ winter, . . . . .	3,000	792
“ “ “ during great freshets, . . . . .	700,000	184,898

The construction of the Habra reservoir was undertaken in 1865 by a private company, formed under a charter from the French government. According to the original plans, the desired storage capacity, which was fixed at 30,000,000 cubic metres (7,924,000,000 gallons), was to be obtained by closing the valley of the stream by a high earthen dam. Two failures, however, of similar works in the province of Oran (Algiers), one situated on the Sig at Tabia and the other on the Tlelat River, caused the projectors of the Habra reservoir to modify their plans by substituting a dam of masonry for one of earth.

The construction of the reservoir was commenced in November, 1865, but, owing to various delays, the work was not completed until May, 1873. After having been in successful use for about eight years, the Habra Dam was ruptured in December, 1881. This catastrophe, which occurred after an unusually severe storm, during which  $6\frac{1}{2}$  inches of rain fell in a very short time, caused the destruction of several villages, of part of the city of Perregaux, situated  $6\frac{1}{2}$  miles from the dam, and the loss of 209 lives. The failure of this dam cannot be attributed to any defect in the design, but was caused, in all probability, by faults in the execution of the work.

The profile of the dam was determined by the method of M. Delocre, and consists, commencing at the top, of a rectangle and three trapezoids having the following dimensions:

---

\* The dams marked T are taken from "Bacini d'Irrigazione," per G. Torricelli. Roma, 1885.

	HEIGHT.		WIDTH.			
	In Metres.	In Feet.	Top.		Bottom.	
			In Metres.	In Feet.	In Metres.	In Feet.
1. Rectangle.....	6.00	19.68	4.30	14.10	4.30	14.10
2. Trapezoid.....	9.60	31.49	4.30	14.10	10.00	32.81
3. Trapezoid.....	10.00	32.81	10.00	32.81	19.10	62.65
4. Trapezoid.....	8.00	26.24	19.10	62.67	26.94	88.39
Total.....	33.60	110.22	.....	.....	.....	.....

A parapet 1.5 metres (4.92 feet) wide by 2.4 metres (7.87 feet) high surmounted the wall, preventing the waves from passing over its top, and serving as a foot-bridge.

What we have described above constituted the dam proper. It was founded entirely on rock, in the following manner: The irregularities of the rock surface were levelled with a bed of concrete, whose average depth was about 4 metres (13 feet). On this was laid a block of rubble masonry 2 metres high and projecting 2 metres beyond the front face of the wall. Upon this foundation the dam proper was built.

The main dam was straight in plan and had a length of 325 metres (1066 feet). It was flanked by an overflow-wall, 125 metres (410 feet) long, making an angle of 35° with its direction. The total length of the dam was therefore 450 metres (1476 feet), the top of the overflow being 1.6 metres (5.25 feet) below that of the main wall.

There were two scouring-galleries 35.7 metres (117.1 feet) apart, and having a cross-section of 1.2 metres wide by 2.24 metres high (3.94 feet by 7.35 feet) at the up-stream face, and of 1.5 metres wide by 4 metres high (4.92 feet by 13.12 feet) at the down-stream face. These galleries were closed by means of iron gates placed at their up-stream ends and worked from the top of the dam by means of rods and the proper gearing for hand-power. By opening the gates yearly it was thought that no deposits would form in their vicinity.

Water was taken from the reservoir by means of two outlets, each being composed of two pipes, 0.80 metre (2.62 feet) in diameter, passing through the masonry.

When the water was first allowed to fill the reservoir, the dam leaked to such an extent that it looked like a large filter. This loss of water ceased, however, in course of time.

The Habra Dam was finished in the winter of 1871-72, but on March 10, 1872, part of the overflow-wall failed during a severe freshet, on account of a defective foundation.

The plans of the Habra Dam and reservoir were prepared under the direction of M. Debrousse, C.E., President of the Society which constructed this work, and verified by M. Feburier, Consulting Engineer. M. Leon Pochet was in charge of the construction from 1869 to the end, and it is from the interesting memoir describing the work which this engineer published in the "Annales des Ponts et Chaussées" for April, 1875, that we have taken the description given above.

The causes which probably led to the failure of the main dam, in December, 1881, are given very fully in the following:

**Extract from a Memoir on the "Rupture of the Habra Dam" by Gaetano Crugnola, Ingegnere Capo Provinciale.\***

"The construction of the dam began in 1866, and the work was finished in 1871. It was founded completely upon a kind of calcareous grit of the Tertiary epoch, which did not present everywhere the same consistency. Between two strata of hard grit which constitute the principal base of the dam there are others more or less soft, alternating with argillaceous strata which had to be removed at certain points to a great depth and were replaced by good concrete. Moreover, we must state, first, that the most important stratum of grit had a very limited depth, which, however, was considered sufficient to support the weight of the whole construction.

"Second. The plane of separation between the grit and the stratum of argillaceous schist of the Miocene period was not far distant, and had an inclination of  $45^{\circ}$  with reference to the horizon and towards the valley.

"Third. The strata of grit were inclined at  $30^{\circ}$  with the horizon.

"The material employed in the masonry had to be procured in the locality, as the construction of such a piece of work (which required 500 cubic metres for each lineal metre) was not possible except by using the building material indigenous to the valley. For so great a mass of masonry the materials had to be close at hand. Consequently, stones from the stratum of Tertiary grit upon which the dam was founded were used. It is important to know, in regard to the Habra Dam, that the strata of grit did not all present the same tenacity. Some had a very pronounced schistose structure, and, although the instructions of the 'Superior Administration' were clear and declared these stones defective, it cannot be assumed with certainty that none of this building material was used.

"The sand employed was not perfectly good. In the beginning of the construction it was taken from the Habra stream, but, when the dam reached a height above the ordinary level of the Habra, the water became stagnant and the quarries were filled with sedimentary deposits. It then became necessary to work some quarries at a greater distance from the place. The sand from these quarries was clean and free from loam, but too fine to make good mortar.

"Moreover, it is important to state that the 'Administration' itself had permitted the use of a red earth instead of sand for the inner part of the dam. Now the red earth contained an excess of clay, amounting to from 22 to 24 per cent of its weight. This is the reason why the mortar could not be relied upon to furnish the necessary resistance.

"The lime, although hydraulic, was not very good. It was made from calcareous rock found on the banks of the Habra River, which contained from 1 to 10 per cent of sand, and from 16 to 31 per cent of clay. For a construction which is destined to retain a column of water 34 metres high an eminently hydraulic lime should be employed, and it ought also to be kept in repose for a certain time before being used, in order to give the quicklime time enough to expand.

"It is known that all cements and hydraulic limes contain a certain quantity of quick-

---

\* Published in the "Ingegneria e Arti Industriali di Pareto e Sacheri," Torino, 1882.

lime which does not expand immediately, but only after a certain time, so that the increase of volume of the cement causes porosity, if not actual cavities in the interior of the masonry.

This property of expansion was known to the French engineer Minard in 1827. From his experiments it appears that this expansion is not completed until twelve months after immersion, and sometimes not until after twenty-two months. This consideration is of great importance. If this expansion in the Habra Dam was on a large scale, it would evidently produce fatal consequences after a certain number of years.

Let us now examine the dam from another point, which will show more clearly the defects which probably existed in the construction. It is not possible to make a dam absolutely impermeable, and the result at "Furens," where only a few humid spots appeared on the outside face of the wall, is to be regarded as exceptional. These filtrations remained for a certain time, and then disappeared completely. In the Habra Dam, however, the filtrations were numerous. When the water reached a height of 10 metres, they appeared soon on the outside face. As the level of the water rose, the leakage increased to such an extent that the dam looked like a gigantic filter.

This phenomenon was attributed especially to the porous nature of the stones which were used. In the course of time the water of filtration deposited on the wall a thin, white, shiny stratum, which was a carbonate of lime like that of which stalactites are composed. This deposit was certainly derived from an excess of lime in the hydraulic cement, which was not transformed into a silicate, but remained dissolved in the water of filtration under the great pressure exerted by the liquid of the reservoir. On coming into contact with the air the lime became a carbonate and was deposited on the face of the wall.

From the above observations we see that the masonry was not suitable for this kind of construction, and that the cement would gradually lose its hydraulic and cohesive properties.

We have examined about all the circumstances which might have affected the stability of the construction, but cannot say definitely which of them caused the rupture of the dam, on account of not having some exact data with reference to the occurrence of that disaster. Nevertheless, we can say that the above-named circumstances, combined with the effect of the inundation of which we shall speak hereafter, caused the destruction of the dam.

The rupture was 100 metres (328 feet) long and 35 metres (115 feet) deep, going down to the base; from which it can be supposed that the foundations also may possibly have sunken. At any rate, the construction of the masonry, as regards the choice of materials, seems not to have been conducted with all the precaution which a work of such magnitude demands.

On the other hand, we ought to observe that the rupture occurred after a disastrous inundation, which was accompanied by very unfavorable meteorological conditions. The hydrographic basin which furnishes the water to the Habra reservoir has an extension of 800,000,000 square metres (309 square miles). In a very short time the height of the water resulting from the rain was observed with an udometer to be 0.161 metre (0.53 foot); and as the rainfall was general in the whole basin, the total quantity of water can be estimated at 128,800,000 cubic metres (34,021,361,000 gallons).

"As the evaporation could certainly not have amounted to much in such a short period of time, we can admit without exaggeration, keeping in mind the filtrations which would have been possible, that the dam permitted the passage in one night of more than 100,000,000 cubic metres of water (26,414,000,000 gallons).

"Now it is easy to understand that such an immense quantity of water would have flowed over the dam, forming a large wave whose height can be calculated at about 1 metre (the flow was about 5000 cubic metres (1,320,705 gallons) per second). As the breast-wall was 2.4 metres (7.87 feet) high above the ordinary level of the basin, the total super-elevation of the water can be placed at 3.90 metres (12.80 feet).<sup>\*</sup> Such an increase in the height of the basin could not, certainly, produce a notable change in the conditions of the stability as regards sliding. The pressure, however, on the exterior face would be remarkably increased. From an approximate calculation, taking into account the obliquity of the resultant, we have found that a super-elevation of 1.50 metres (4.92 feet) above the ordinary level would be sufficient to cause pressures of 12 to 13 kilos. per square centimetre (12.29—13.31 tons of 2000 lbs. per square foot). From what we have said above, it will be seen that the super-elevation was more than double the one we have assumed in the calculation, and that the masonry was consequently exposed in an extraordinary manner above the limits of safety, the conditions becoming still more unfavorable from the circumstance that the water overflowed the top like a gigantic cascade.

"In view of the catastrophes that may occur by constructing a reservoir, it will be asked if it is necessarily dangerous to accumulate such an immense quantity of water; but we reply without hesitation, No. The rupture of a dam which retains such a great volume of water will certainly be dangerous, especially if it is situated near populated places. But it can be asserted generally, that in the construction of such a wall we can follow all the laws depending upon its static conditions and the pressure of the water, which can be determined with certainty and without establishing any hypotheses which do not conform to the reality. If the masonry is carefully built, as it ought to be, both in the interior as well as in the points which join the bottom and lateral faces, no danger of rupture need be feared."

**The Tlelat Dam<sup>T</sup>** (Plate LI.) was built in 1869 on the Tlelat River to supply the village of Sante Barbe, situated at a distance of about  $7\frac{1}{2}$  miles from its site, with water, and also for irrigation purposes. Its general dimensions are:

	Metres.	Feet.
Length on top, . . . . .	99.0	324.80
Height, . . . . .	21.0	68.90
Thickness at top, . . . . .	4.0	13.12
"    "    base, . . . . .	12.3	40.34

The maximum pressure in the masonry is 6 kilos. per square centimetre (6.14 tons of 2000 lbs. per square foot), and the back face has some tension. The capacity of the reservoir is 550,000 cubic metres (145,278,000 gallons), and the watershed supplying it contains 13,000 hectares (51 square miles).

---

<sup>\*</sup> The height of the wave observed at the moment of the rupture was 3.50 metres (11.48 feet).



The back face of the dam is vertical; the front face is circular, having a radius of 40 metres (131.23 feet), the centre of the circle being 3.60 metres (11.81 feet) above the top of the dam. A parapet 1 metre high by 1.50 metres wide surmounts the wall. It has been decided to raise the dam 6 metres higher in order to obtain more storage.

**The Dam of Djidonia<sup>r</sup>** (Plate LII.), located on the river of this name, was built in 1873-75 to supply the villages of St. Aimé and Amadema with water. The reservoir has a capacity of 2,000,000 cubic metres (528,282,000 gallons), and is supplied from a hydrographic basin containing 85,000 hectares (328 square miles).

The dam was built straight in plan. Its general dimensions are :

	Metres.	Feet.
Height above foundation, . . . . .	17.0	55.78
“ of foundation, . . . . .	8.5	27.89
Thickness at top of dam, . . . . .	4.0	13.12
“ “ base of dam, . . . . .	11.5	37.73
“ of foundation, . . . . .	16.0	52.50

The maxima pressures are :

	Kilos per square centimetre.	Tons of 2000 lbs. per square foot.
Above foundation, . . . . .	6.0	6.14
At base of foundation, . . . . .	9.43	9.65

The inner face has a tension of more than 1 kilo. per square centimetre, but this does not seem to have injured the masonry.

The profile is bounded by a vertical line up-stream, and on the down-stream side by a straight line having a slope of 0.055 to 1 for a depth of 6 metres (19.69 feet) from the top, and then by a circular curve whose centre is 4.50 metres (14.76 feet) below the top of the dam and whose radius is 19 metres (62.34 feet).

It has already been decided to raise this dam 8 metres (26.25 feet), increasing thus the capacity to 5,000,000 cubic metres (132,062,000 gallons).

**The Gran Cheurfas Dam<sup>r</sup>** (Plate LIII.), situated on the Mekerra River (Sig.) at a distance of about 9 miles from St. Dionigi, was constructed in 1882-84. Its general dimensions are :

	Metres.	Feet.
Length on top, . . . . .	155	508.40
“ at base, . . . . .	50	164.04
Height above foundation, . . . . .	30	98.42
Width at top, . . . . .	4	13.12
“ “ base, . . . . .	22	72.18

The dam is composed: (1) Of a foundation-mass of rubble 10 metres (32.81 feet) high, 41 metres (134.52 feet) thick at the base and 24 metres (78.72 feet) on top; (2) Of the wall proper, having both faces formed of parabolic surfaces.

The two parabolæ which bound the profile have the same axis, which is horizontal and at the level of the top of the dam. The vertices of the parabolæ are respectively at the front and back edge of the top of the profile. At the top of the foundation the up-stream parabola has an abscissa of 3.00 metres (9.84 feet), and the down-stream curve has an abscissa of 15 metres (49.21 feet).

The maximum pressure on the masonry is 6 kilos. per square centimetre (6.14 tons of 2000 lbs. per square foot), and the back face has some tension.

The capacity of the reservoir is 16,000,000 cubic metres (4,226,256,000 gallons). In 1885 part of the dam failed, the length of the breach being 40 metres (131.24 feet); but the dam has since been repaired.

**The Dam of Hamiz<sup>T</sup>** (Plate LIV.) is situated on the Hamiz River at a distance of about  $4\frac{1}{2}$  miles from the village of Foundouk. It was built in 1885 to form a reservoir of 13,000,000 cubic metres (3,433,833,000 gallons) capacity. The watershed of this reservoir contains 14,000 hectares (54 square miles). The dam is built of rubble masonry, is straight in plan, and has both faces curvilinear.

The general dimensions of the dam are as follows:

	Metres.	Feet.
Length on top, . . . . .	162.0	531.60
“ at base, . . . . .	40.0	131.24
Height above bed of river, . . . . .	38.0	124.68
“ “ foundation, . . . . .	41.0	134.52
Thickness at top, . . . . .	5.0	16.40
“ “ base, . . . . .	27.8	91.21

At a depth of 28.84 metres (94.62 feet) from the top the front face has an offset of 1 metre, the thickness of the dam at this point being 18.85 metres (61.85 feet).

The maximum pressure at the front face is 11 kilos. per square centimetre (11.25 tons of 2000 lbs. per square foot). The maximum tension at the back face is 3 kilos. per square centimetre (3.06 tons of 2000 lbs. per square foot).

The profile of this dam was determined by the French method of “equal resistance.” \*

---

\* See page 2.

## CHAPTER XI.

## DAMS IN EGYPT.

**The Rosetta and Damietta Dams\*** were constructed across the two branches of the Nile bearing their respective names, at the head of the Delta of Egypt, to obtain water for irrigating the Delta. The two branches of the river divide the Delta into three divisions, each of which is supplied with water by an irrigation canal.

Napoleon Bonaparte, when in Egypt in 1798 and 1799, predicted the construction of a dam at the head of the Delta to control the distribution of the water of the Nile into its two branches. Such a work was begun in 1833 by the Viceroy Mehemet Ali, who was so impatient to have it completed that he crowded a great many more laborers on the work than could be employed to advantage. In order to obtain the stone for the dams, he proposed to tear down the famous Gizeh Pyramids, and it was only by the engineer producing estimates to prove that it would be cheaper to quarry the stone that this act of vandalism was avoided. The work was stopped in 1835 on account of a plague.

The scheme of building the two dams was revived in 1842 by Monsieur Mougel (afterwards Mougel Bey), who managed to interest Mehemet Ali in the project by combining plans for fortifications with those for the dams. These plans were executed in 1843-52. The original plans were somewhat modified. As finally built the Rosetta Dam has 61 arches and two locks, one at each end, and is 465 metres long between flanks. The Damietta Dam had originally 71 arches (since reduced to 61) and two locks, its length being 535 metres. According to the original design the dams had respectively 72 and 62 arches and each was provided, also, in the centre with a navigable opening 14.50 metres in width, which was always to remain open. Two arches, each of 5.50 metres span, were substituted for the navigable openings, and the place of three end arches was occupied by a lock constructed on that flank of the dam, where none had been originally provided. With the exception of the central arches just mentioned, all the others have spans of 5 metres.

The original gates for closing the openings between the piers were shaped as the arc of a circle, supported at either end by iron rods radiating from the centre of the arc, where they were attached to massive iron collars, working round cast-iron pivots embedded in the masonry of the piers. These gates were to be lowered by their own weight and to be raised by compressed air pumped into the hollow ribs, but they could not be operated successfully and

---

\* "History of the Barrage at the Head of the Delta of Egypt," compiled by Major R. H. Brown (late R.E.), Inspector-General of Irrigation in Lower Egypt.

were replaced after 1884 by wrought-iron gates provided with rollers sliding in cast-iron grooves fixed in the piers, according to F. M. Stoney's patent. As the maximum depth of water on the floor of the dam is  $4\frac{1}{2}$  metres, each opening was given double grooves and two gates, the upper one being always  $2\frac{1}{2}$  metres high. In the Damietta Dam the lower gates are all 2 metres high, but in the Rosetta Dam their heights vary from 1 to  $2\frac{1}{2}$  metres owing to differences in the level of the floor between the piers, caused by repairs that were made after the dam had been completed. Powerful crab winches (two for each dam) traveling on continuous rails serve for lowering or raising the gates.

Originally an iron grating, 30 centimetres high, was fixed into the piers across each opening between the bottom of the gates and the floor surface. These gratings were to allow some water to pass through the dam even when the gates were down, and were thus to prevent the deposit of mud in front of the gates. With a head of 1.75 metres the gratings of the Rosetta Dam discharged over 20,000,000 cubic metres per day. The gratings were subsequently closed to avoid the loss of water they entailed and its scouring action below the dam, which at one time was supposed to be due to a honeycombed foundation.

The two dams are separated by a revetment wall about 1000 metres long, in the middle of which one of the irrigation canals begins.

The Damietta Dam was commenced first and was completed without any special difficulties being encountered. The construction of the Rosetta Dam was begun in June, 1847. Impatient to have the work completed, Mehemet Ali ordered 1000 cubic metres of concrete, to be laid daily, regardless whether this could be done advantageously or not. The river happened to be a metre higher than in the preceding year, but the Viceroy's orders had to be obeyed, and concrete was dumped into the foundation-trench in many places before it had been excavated to the proper depth. The folly of such hasty and defective construction was seen later when numerous leaks occurred under the dam and cracks appeared in the walls.

Owing to the scour along the east bank of the Rosetta Branch, the river bottom at this bank was about 10 metres below the elevation fixed as the bottom of the foundation of the dam. At the west bank a considerable deposit of silt had to be excavated before the foundation-level of the dam was reached. Cofferdams enclosing about five arches were used in constructing the dam. After the silt had been excavated to the desired depth concrete 3 metres deep was laid to form the floor of the dam and covered with brick and stone masonry 0.5 metre deep. On this floor the piers were built. At the eastern bank the river bed was raised to the elevation of the bottom of the foundation by dumping in loose stone. The interstices of this mass of stone soon became filled with silt and, contrary to expectation, this part of the foundation proved to be about the most water-tight of any. The cofferdams were constructed right on top of this mass of loose stone and silt, the sheet piles being driven in as far as possible. Sail-cloth was laid on the up-stream side of the piles and held in place by the force of the current. As much of the concrete for this part of the dam was placed in running water, a considerable quantity of the mortar was washed away, leaving the masonry honeycombed. Much of this concrete was found to be as soft as puddling, but in some places it set as hard as rock.

No unusual difficulties were encountered in building the foundations within the cofferdams except at arches 7 to 10 near the east bank, where sand of a particularly fine quality, dark in color and very light, with the springs strongly impregnated with decayed organic

matter, was met with. Although the dredger was working in still water, this sand poured in so fast between the sheet piles that the excavation could not be carried down to the desired depth. The concrete at this place had consequently only a depth of about 1.50 metres. Cracks appeared in the superstructure before the dam was subjected to pressure, and this part finally failed and was surrounded by a coffer-dam.

Mehemet Ali died in 1848 without seeing the dams completed. He was succeeded by Allas Pasha, who had no faith in the project and wished to abandon the construction of the dams. He dismissed Monsieur Mougel in April, 1853, and placed Mazhar Bey in charge of the work. Public opinion obliged the new Viceroy to continue the construction, which was finally completed by 1861, at a cost for the dams, including pathways, parapets, turrets, etc., of \$9,400,000, exclusive of the work done by enforced, unskilled labor, known as *Corvée* labor. Mr. Willcocks in his "Egyptian Irrigation" places the total cost of the dams, fortifications, canal-heads, etc., at about \$20,000,000.

In 1863 the gates of the Rosetta Dam were closed for the first time, in order to supply more water to the Damietta Branch. The water-level above the dam was raised 1-1.40 metres. Under this pressure sand was forced out from below the floor of the dam and ominous cracks appeared in the wall. In 1867 a whole section of the Rosetta Dam, consisting of ten openings towards the west end, separated from the rest of the dam and was moved perceptibly down-stream. A coffer-dam 5 metres high by 2 metres wide was built around these ten openings and filled with stiff clay, overlaid by stone resting on the platform.

During the construction and after the completion of the dams a number of commissions of Experts and Consulting Engineers were appointed to give their advice in connection with the work. The well-known English engineer Sir John (then Mr.) Fowler examined the dams in 1876 and pronounced the piers and arches to be of good construction but the floor to be defective. General J. H. Rundall, R.E., formerly Inspector-General of Irrigation to the Government of India, also, reported on the dams in 1876, and gave his advice as to what had to be done to make the structures safe. As the result of all these Commissions and Reports, and contrary to some of their conclusions, Rousseau Pasha, Director of Public Works, in his yearly report of 1883 on irrigation condemned the dams and stated that in their existing condition they could only be used to distribute the flow of the river between its two branches.

In May, 1883, Sir Colin (then Colonel) Scott Moncrieff was placed by the Egyptian Government in charge of the Irrigation Department and Works, and a new period in the history of Egyptian irrigation commenced with his administration. In December, 1883, he placed Mr. Willcocks, who had come from India to join the Egyptian Irrigation Service, at the dams to examine their condition. Improved sliding gates were introduced, as already stated, the gratings in the piers were closed, and various repairs were made in addition to those already executed after the completion of the construction.

In the summer of 1885 the Nile was very low, but the dams were made to retain as much as 3 metres on the Rosetta Branch and 1.76 metres on the Damietta Branch, giving the canals an increased level of 10 centimetres over the supply of 1884. But some of the cracks in the Rosetta Dam widened and there was a down-stream subsidence of the old coffer-dam put in years before to protect this most doubtful part of the work. The

pressure was relieved as much as possible by throwing masses of stone round the cracked portion.

In 1885 a loan of a million pounds sterling was obtained for irrigation works, and Lieut.-Colonel Western came from India to direct the construction of the works to be built under this loan, the most important of which was the restoration of the two dams across the Nile. At first Colonel Western thought seriously of abandoning these structures, but in 1886 the floor of part of the Rosetta Dam was successfully exposed for examination by the simple plan of forming earth banks so as to enclose 20 arches at the west end of the dam, and pumping out the water ( $4\frac{1}{2}$  metres deep) from the enclosed space, and as a result of this examination it was decided to restore the dams. This work consisted, in addition to necessary repairs to the foundation, in extending the floor up- and down-stream so as to increase the strata under the dam through which all leakage had to pass. To give additional security to the old work the existing floor was covered with a layer of Portland-cement concrete 1.25 metres thick, over which was laid a heavy pavement of dressed Trieste ashlar stone under the arches and over the down-stream apron, where the action of the river was most severe. The floor was extended up-stream 25 metres in rubble limestone masonry. Sheet piles, 5 metres long, were driven along the up-stream edge of this extension.

Owing to special difficulties the new flooring often exceeded 2 metres in thickness. The floor of the Rosetta Dam as restored varies in thickness and is unlike that of the Damietta Dam, the floor of which is at the same level.

The work of restoring the Rosetta Dam was begun in 1887 and completed by June 16, 1890. The total cost of restoring both dams has been 465,000 pounds sterling. The benefits resulting from the work done in 1887-1890 have been so considerable as to fully justify the expenditure incurred. Prior to 1884 the maximum head retained by the Rosetta Dam was 1.75 metres. The Damietta Dam was always open. Since the completion of the restoration the maxima heads retained by the two dams have been respectively 4.07 and 3.72 metres.

**The Assuan Dam\*** (Plates E and F) was constructed in 1898 to 1903 across the Nile at Assuan, about 700 miles from the Mediterranean, in order to retain the flood-waters of the river for irrigation.

At the site of the dam the maximum flow of the river in an average year is about 353,000 cubic feet, while the minimum flow amounts to only 14,000 cubic feet.

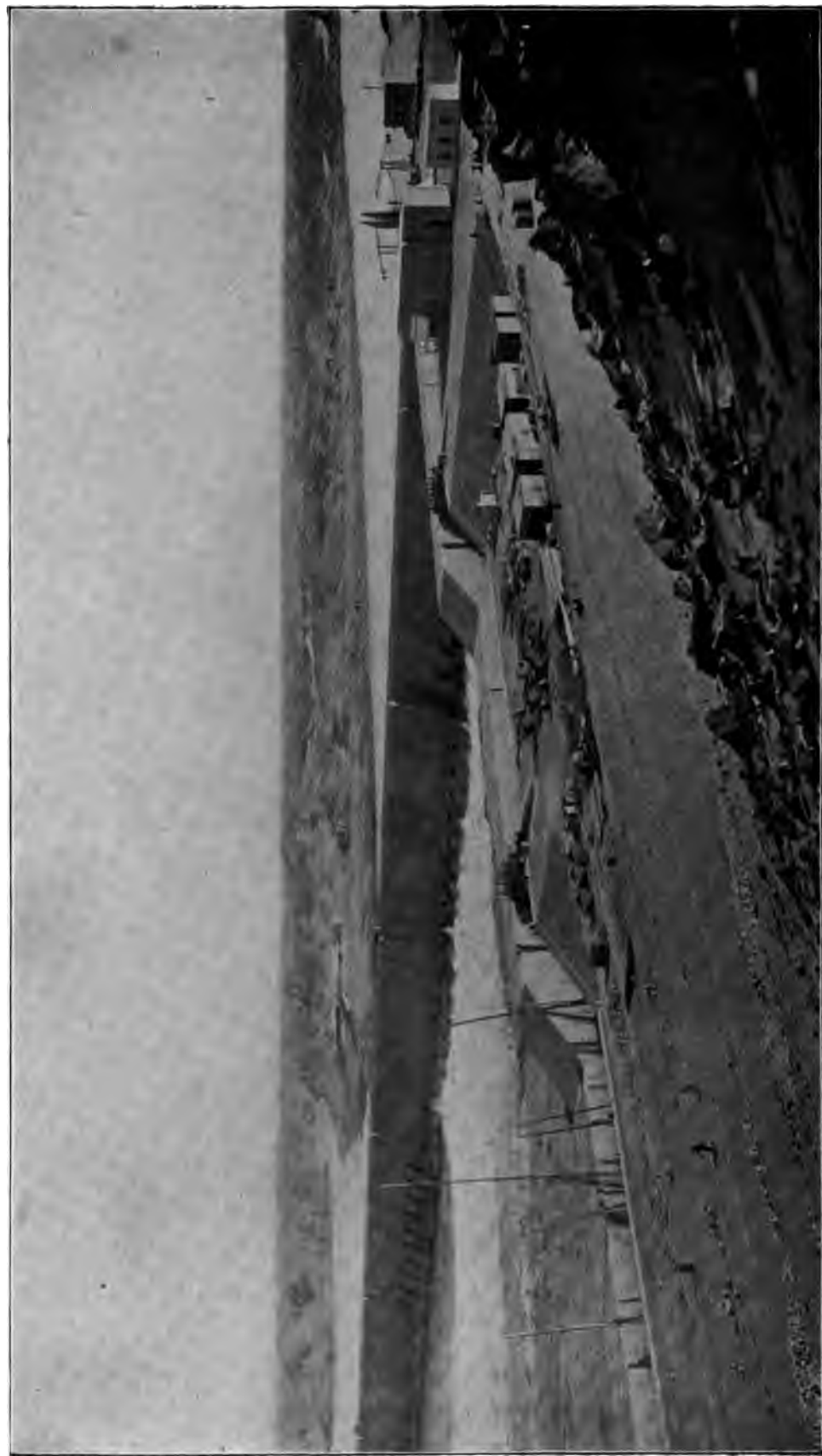
The importance of storing the excess of water during seasons of flood was recognized as early as the days of Mehemet Ali. By retaining the water in this manner, what is known as perennial irrigation can be substituted for the ancient basin system, and two or three crops can be raised per year instead of one.

Various reports upon the project of constructing a dam across the Nile at Assuan were made by different engineers. Mr. Willcocks (now Sir William Willcocks, K.C.M.G.), M.Inst.C.E., Director General of Reservoirs for the Egyptian Government, published reports on this project in 1890 to 1894. An International Commission, composed of Sir Benjamin Baker, Signor Torricelli, and M. Boulé, made later a report on this subject.

\* See *The Engineer*, London, Dec. 12, 19, 26, 1902; "The Nile Reservoir Dam at Assuan," by W. Willcocks, C.M.G., M.Inst.C.E., London, 1901; also, paper by Maurice Fitzmaurice, C.M.G., B.A.I., in *Proc. Inst. C. E.* for January, 1903.



PLATE E.



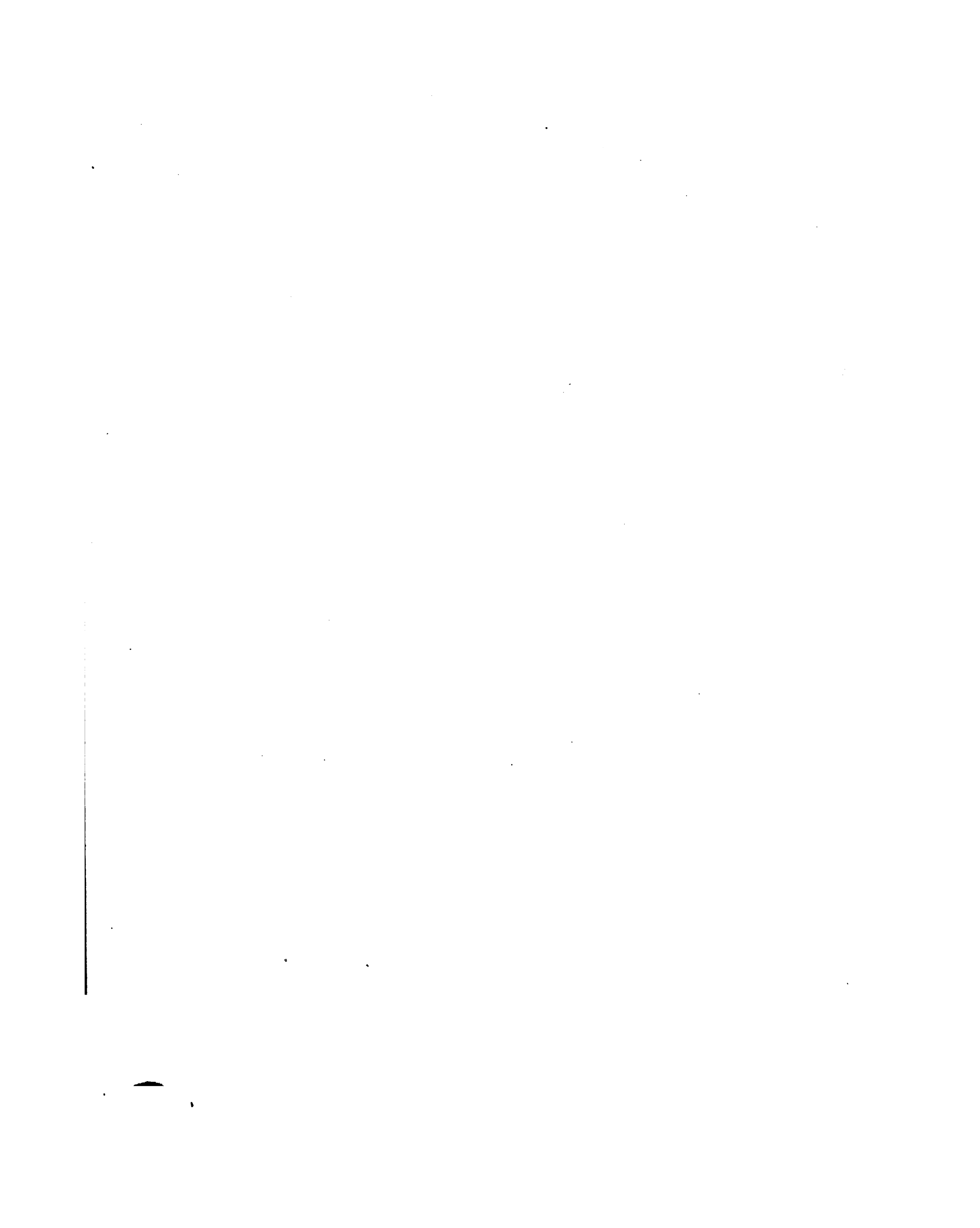
ASSUAN DAM.



PLATE F.



ASSUAN DAM.



In 1898 a contract for constructing the Assuan Dam and a directing weir at Assiout, 350 miles down-stream, was awarded to Sir John Aird & Co., an English firm of contractors, for £2,000,000, which was to be paid in 60 half-yearly instalments of £78,613, commencing on July 1, 1903, the date fixed for the completion of the work.

At the time of the signing of the contract, the late Mr. W. J. Wilson, M.Inst.C.E., had succeeded Mr. Willcocks as Director General of Reservoirs, and on Mr. Wilson's death in August, 1900, Mr. A. L. Webb, C.M.G., M.Inst.C.E., took his place. Sir Benjamin Baker, K.C.B., K.C.M.G., was appointed Consulting Engineer of the Egyptian Government, and Mr. Frederick Wilfrid Scott Stokes, M.Inst.C.E., was placed in immediate charge of the work. He was succeeded in December, 1901, by Mr. C. R. May, M.Inst.C.E., who had previously been principal assistant.

The plans adopted for the Assuan Dam were practically those prepared by Mr. W. Willcocks in 1895, with the exception of the cornice and the further change that the dam was located on a straight line, whereas Mr. Willcocks had chosen a broken line for the location with a view of making the average depth of the foundation as little as possible.

The Assuan Dam had to be constructed in such a manner as to be able to discharge through sluices the whole flow of the Nile (the maximum recorded being 494,500 cubic feet per second in 1878-79) during the period when the river carried much silt, viz., July 1st to December 1st. No water was to pass over the top of the dam.

The site of the dam was selected at the head of the first cataract of the Nile, at Assuan, where the whole structure could be founded on rock, and where there was an abundance of good granite for the masonry.

The length of the dam is about 6,400 feet, including a lock on the west bank. It consists of two parts: a solid masonry dam 1,800 feet long commencing on the east bank, and a masonry dam 4,600 feet long containing the sluices and the lock on the west bank. The whole structure contains about 700,000 cubic yards of masonry.

Plate LV\* shows the profile of the solid part of the dam. The greatest height of the dam above the foundation is about 96 feet, the maximum depth of water in the reservoir being about 65.6 feet at the dam. The top of the dam is 9.84 feet above high water. It is 23 feet wide where the sluices are located and 17.78 feet wide for the solid wall. The batters of the down-stream and up-stream faces are respectively 1 in  $1\frac{1}{2}$  and 1 in 18. The roadway running along the top of the dam is 16.4 feet wide for the part that contains the sluices and only 9.8 feet wide for the solid part.

With two exceptions, the sluices are divided into groups of ten, the length of solid wall between the individual sluices being 16.4 feet. Between two adjoining groups of sluices there is a length of 32.8 feet of solid wall, and buttresses 26 feet wide and 3.77 feet thick are added at these points, for the sake of appearance rather than for strength. These buttresses are about 240 feet apart.

There are 180 sluiceways through the dam, viz., 140 lower sluices 6.56 feet wide by 22.96 feet high and 40 upper sluices 6.56 feet wide and 11.48 feet high. They are located at four different levels. Sixty-five sluices were placed with their sills practically on a level with the bed of the river. Forty of these sluices are lined with cast iron and the

---

\* A copy of an official drawing, from which this plate was made, was kindly loaned the author by Mr. Frederick Cope Whitehouse, who also furnished valuable information about the dams in Egypt.

remaining ones with ashlar masonry. According to the original plans all sluiceways were to be lined with ashlar. Cast iron was only resorted to to expedite the work at points where the foundation had to be carried down to a considerable depth.

The plates used for the cast-iron lining are  $1\frac{3}{8}$  to  $1\frac{1}{2}$  inches thick. Each plate has two vertical ribs 11.8 inches deep, which bond into the masonry. The plates are connected together at the vertical webs by  $1\frac{1}{2}$ -inch bolts. A layer of felt about  $\frac{1}{4}$  inch thick is placed between the flanges of the vertical ribs to admit expansion.

Seventy-five sluices have their sills 14.76 feet above the river-bed. Twenty-five of these sluices are provided with self-balanced roller gates of the Stoney kind, the remaining fifty having ordinary sliding gates, which are only operated when the "head" of water has been sufficiently reduced.

Eighteen sluiceways were placed 27.88 feet and twenty-two sluiceways 41 feet above the bed of the river.

The arrangement of sluiceways described above makes it possible to draw down the reservoir gradually without having too much head on the sluice-gates.

The body of the dam is constructed of granite rubble masonry laid in Portland-cement mortar, mixed 4 to 1, except in the foundation and at the sides, where it is 2 to 1. The slopes are faced with squared, rock-faced granite, laid in courses varying from 12 to 24 inches in thickness. This masonry was laid on the up-stream slope in 2 to 1 Portland-cement mortar and on the down-stream slope in similar mortar, mixed 4 to 1. The facing-stones were laid by means of derricks, but the body of the dam was formed of stones that could be carried on men's backs from the wagons to the dam. The average weight of the masonry is about 149.5 pounds per cubic foot.

The maxima pressures in the masonry are calculated to be at the down-stream and up-stream faces respectively 4 and 5.8 tons per square foot.

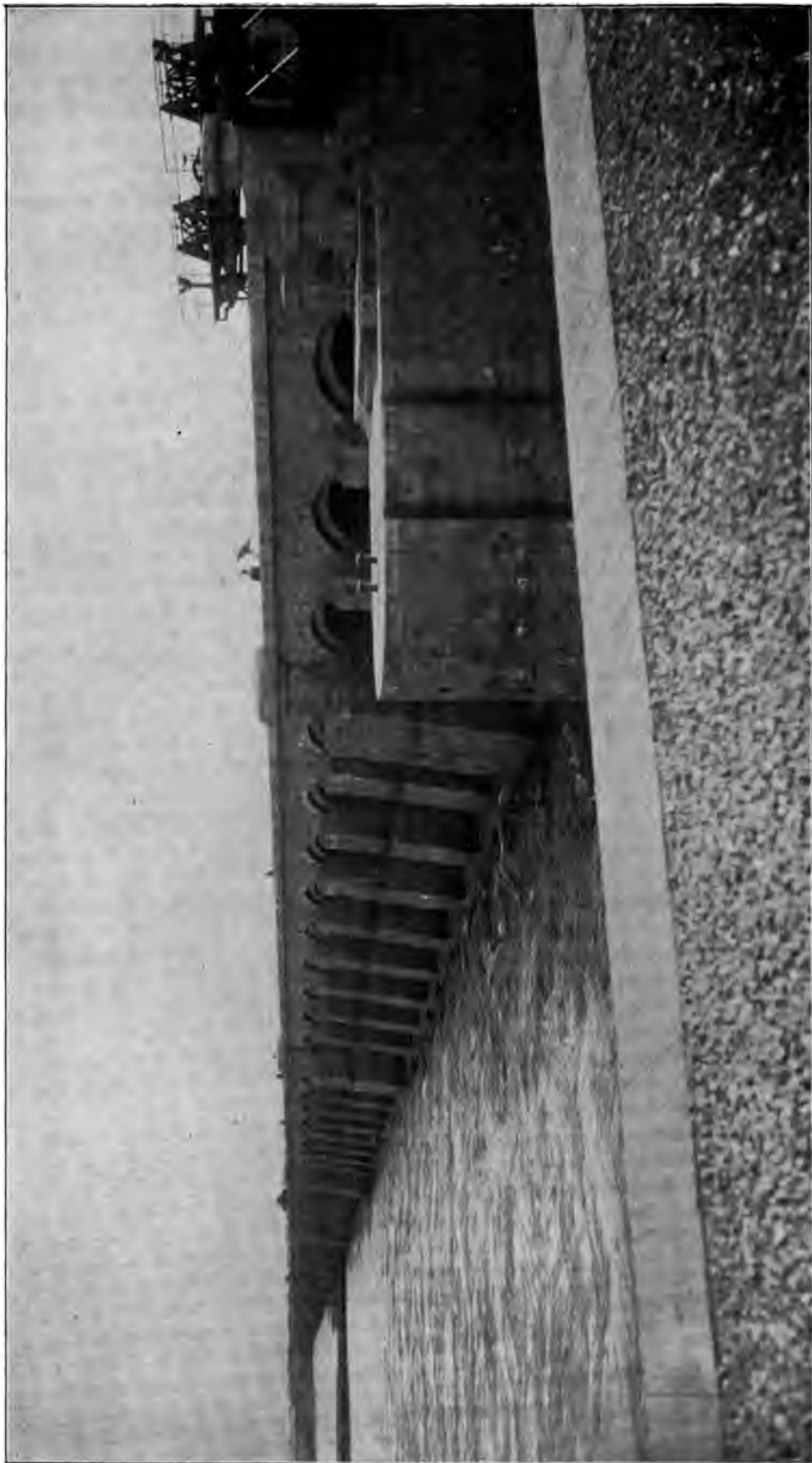
In order to permit navigation past the dam a canal was constructed on the west bank of the river, partly in rock excavation and partly on embankment. It is about 6,540 feet long, 49.2 feet wide on its bed, and has four locks, which provide for a total descent of 68.9 feet. Each lock has a total length of 263 feet and a bottom width of 31.2 feet.

The lock gates range in height from 62.34 to 29.53 feet and have to be worked under a head of 5 to 66 feet according to whether the reservoir is empty or full. They are all single-leaved gates of the Stoney pattern and roll into recesses, constructed in the masonry sides of the locks, at right angles to their general direction. Each gate is suspended from a carriage supported by rollers and traveling on a pair of rails, which rest on a bridge. The portion of the bridge over the recess is fixed, but the part over the lock is hinged at one end and is raised into a vertical position when the gate is in the recess. When the gate is to be closed, the hinged part of the bridge is lowered and the gate is moved across the lock and rests against steel groins at the sides and on a steel sill at the bottom. Valve openings are provided in the gates for filling or emptying the locks.

About December 1st the water of the Nile is usually free of silt. The gates are to be closed about this time and the reservoir is to be filled during the months of December, January, and February. The reservoir will usually be drawn down during the months of May, June, and July.

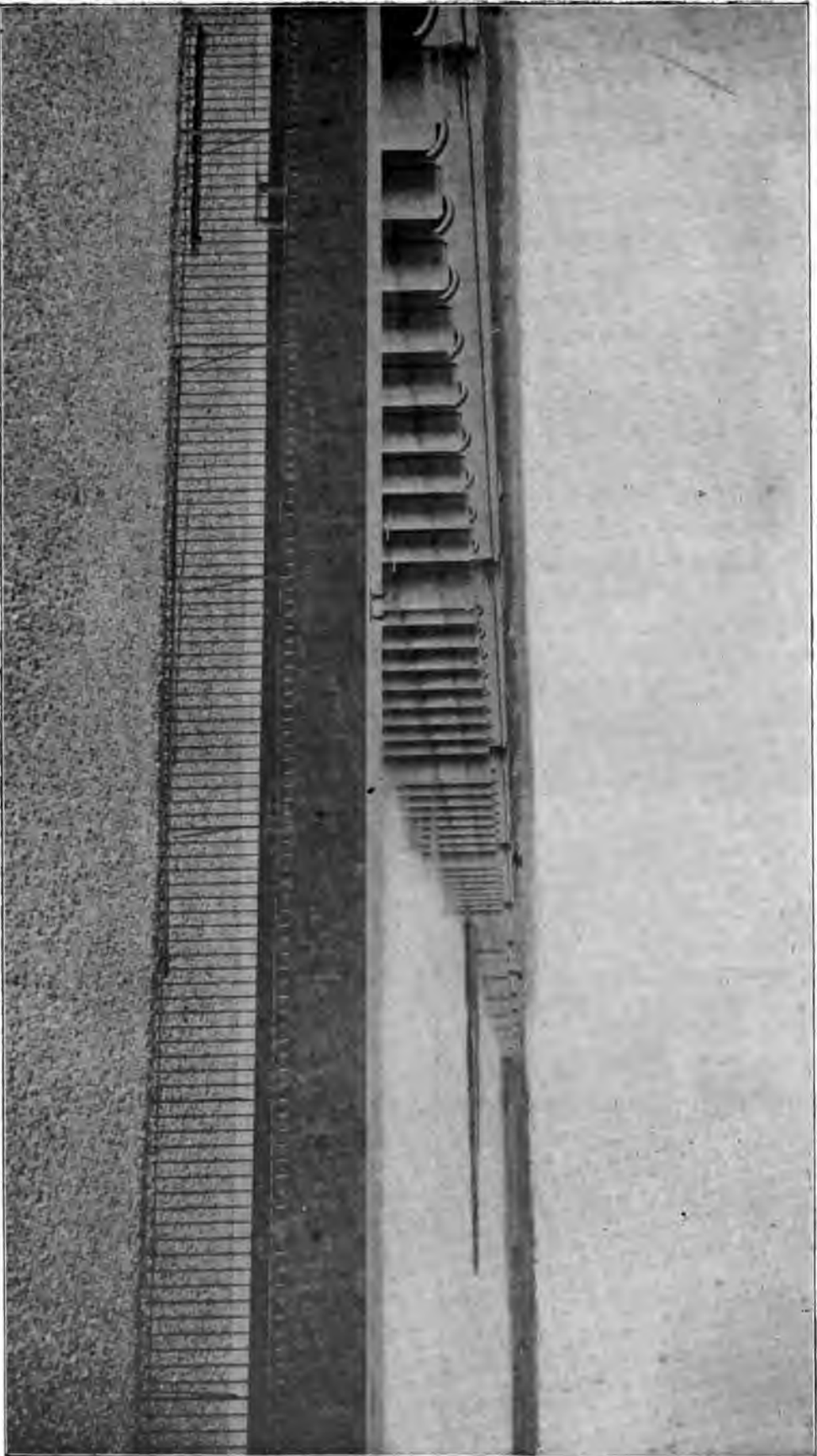


PLATE G.



ASSIOUT DAM.

PLATE H.



ASSIOUT DAM.





The reservoir has a length of about 143 miles, including the river-bed where the water level has been raised and will store about 37,612 million cubic feet.

The work of constructing the Assuan Dam was commenced in the summer of 1898. The first stone was laid in the dam on February 12, 1899, by the Duke of Connaught and the masonry was finished by June, 1902, about a year ahead of the contract time. This speed in the construction was made possible by the very low level of the river for two consecutive years. The work done included 824,000 cubic yards of excavation and 704,000 cubic yards of masonry.

The sluice-gates of the dam were closed for the first time on October 20, 1902. The works on the Nile were formally opened on December 10, 1902, by the Khedive and by the Duke of Connaught.

The contract price was £1,500,000 for the Assuan Dam and £500,000 for the Assiout weir. Owing to the fact that the foundation had to be excavated in some places to a much greater depth than expected, the actual cash cost of the Assuan Dam amounted to £2,450,000, which is about £62.5 per million cubic feet stored or £10 per million imperial gallons.

**The Assiout Dam** (Plates G and H) was constructed in 1898 to 1903 across the Nile, about 350 miles down-stream from the Assuan Dam in order to divert the water of the river at low water into two large irrigation canals.

The dam consists of a masonry dam about 2,769 feet long extended on both sides by earthen banks, making a total length of about 3,937 feet.

There are 111 arched openings of 16 feet 4 inches span in the masonry dam. They can be closed by steel sluice-gates 16 feet high. The piers and arches are founded upon a masonry platform 87 feet wide by 10 feet thick. This platform is protected on its up-stream and down-stream sides by a continuous and impermeable line of cast iron tongued and grooved sheet-piling with cemented joints. This piling extends into the sand bed of the river to a depth of 23 feet below the upper surface of the platform and prevents it from being undermined.

The river-bed is protected against erosion for a width of 67 feet up-stream by a stone paving laid on a clay puddle to check infiltration, and on the down-stream side for the same width by a stone paving having an inverted filter-bed underneath, so that any springs that may be caused by the water above the sluices shall not carry sand with them from beneath the paving.

The piers between the openings have a length of 51 feet up- and down-stream and are 6.56 feet wide with the exception of every thirtieth pier, which has double this width. The roadway is 41 feet above the top of the masonry platform.

The dam has a maximum height of about 48 feet, the maximum head of water retained being about 33.5 feet. It is constructed of granite, the foundation platform mentioned above being of concrete.

A lock 262.5 feet long by 52.8 feet wide and capable of passing the largest Nile steamers was constructed at the dam.

## CHAPTER XII.

## DAMS IN ASIA AND AUSTRALASIA.

**The Poona Dam** (Plate LVI.) was constructed to form a large reservoir, Lake Fife, on the Mutha River, 10 miles west of Poona, for irrigating a large district of land near Poona and also for furnishing that place with a water-supply.

This project was first proposed by Col. Fife, R.E., in 1863, but the final plans were not approved and the work commenced until the latter part of 1868.

The dam was founded on rock and constructed entirely of uncoursed rubble. Its maximum height is 98 feet above the river-bed and 108 feet above the foundation. Its length is 5136 feet, 1453 feet of which form the waste-weir, whose crest is 11 feet below the top of the dam.

The line of the dam is formed of different tangents. At their intersections the wall is reinforced by heavy buttresses of masonry. The top-width of the dam, on the different tangents, varies according to the height of the structure.

As the masonry showed signs of weakness after being completed and subjected to water-pressure, it was reinforced by an earthen bank, having a top-width of 60 feet and a height of 30 feet, which was constructed against the lower face of the dam. The total cost of the structure was \$630,000.

The dam backs up the water for 14 miles and forms a reservoir having a capacity of 3,281,200,000 cubic feet and a surface of 3681 acres. Only 19 feet of depth of water is available, owing to the elevation which had to be given to the canals that are fed from the reservoir.

The catchment basin, above the dam, contains 196 square miles on which the annual rainfall is about 200 inches.

**The Tansa Dam**† (Plate LVII.) was constructed to form a large reservoir for the water-supply of Bombay. This project was first proposed by Major Hector Tullock, R.E., in 1870. The final plans were prepared by Mr. W. Clerk, who has had full charge of the construction of the works as Executive Engineer.

The total length of the dam is 8800 feet and its maximum height above the foundations is 118 feet. The structure is, however, designed sufficiently strong to permit of its height being increased 17 feet, in which case its length would be 9350 feet.

---

\* Irrigation in India, by Herbert M. Wilson (see XIIth Annual Report, U. S. Geological Survey).

† See Engineering News, June 30, 1892.

" Engineering Record, December 19, 1891.

" XIIth Annual Report of the U. S. Geological Survey. Irrigation in India, by Herbert M. Wilson.

1650 lineal feet of the dam forms the waste-weir, the crest of which is 3 feet below the top of the dam.

The reservoir has an area of 8 square miles. The available depth of water above the sill of the discharge-slucies is only 20 feet. The net available capacity of the reservoir is 691,300,000 cubic feet, but this might be much increased, if necessary, by placing the sluice-gates lower.

The catchment basin above the dam is only  $52\frac{1}{2}$  square miles. Owing to the steepness of the slopes and a rainfall of 150–200 inches per annum, the daily discharge from this basin is estimated at about 8,000,000 cubic feet per day.

The site of the dam is in a dense forest and jungle. To carry on the work a village had to be built for the native workmen and a macadamized road, 8 miles long, had to be constructed to the nearest railroad station.

The dam was founded throughout on rock, the excavation for the foundations being in places 45 feet deep. Its alignment consists of two tangents, located so as to make the excavation to the bed-rock as little as possible.

The dam was constructed entirely of uncoursed rubble masonry, roughly scabbled on the facing. The stones used were hard trap or greenstone, in pieces which could be carried by two men.

An excellent hydraulic lime was obtained from the nodules of limestone, called kunker, which are found in the ground in abundance. Most of the cement used in India is obtained from these kunkers, which are generally about the size of a man's fist, although in the Ganges Valley they are found in blocks weighing 100 pounds or more. They are found in the clay deposits, which are very abundant in India.

The cement was burnt at the site of the dam. Kunker nodules were excavated some feet below the surface of the ground, exposed to the sun, dried, beaten, and washed clean, before being burnt.

The sand used, clean, sharp trap or quartz, was carefully washed before being mixed with the cement.

Some idea of the magnitude of this piece of construction can be formed by the following items of work performed:

Total excavation, . . . . .	251,127 cubic yards.
Loose rubble-stone, . . . . .	544,700 " "
Lime, . . . . .	81,700 " "
Washed sand, . . . . .	122,555 " "
Rubble masonry, . . . . .	408,520 " "

The proportion of the mortar (consisting of 1 part cement to  $1\frac{1}{2}$  parts of sand) in the masonry was found by a careful calculation to be  $36\frac{7}{8}$  per cent. In the lower part of the dam some Portland cement was used.

The largest amount of masonry per month was laid in January 1891, when 700 masons laid 26,000 cubic yards of rubble.

During the working season (May to October), 9000–12,000 men were employed on the work.

During the rainy season the work had to be suspended.

The construction was commenced by the contractors, Glover & Co., in March 1886, and completed in April 1891, 15 months ahead of the contract time.

The cost of the dam was about \$1,000,000.

The masonry has proved to be perfectly water-tight.

**The Bhatgur Dam\*** was constructed on the Yeluand River, about 40 miles south of Poona, in the Presidency of Bombay, to form a large reservoir for irrigation purposes. The uncertainty of the rainfall in a portion of the Poona collectorate led Col. Fife, R.E., in 1863, to make surveys to find some means of supplying this region with water. This work was soon discontinued, but resumed subsequently by Mr. J. E. Whiting, C.E., and continued to 1871, when the final plans were decided upon.

The works were carried out under the direction of Mr. Whiting. They consist of the Bhatgur reservoir, having a capacity of 5,510,740,000 cubic feet, of the Nira canal, 129 miles long, and of a diversion-weir, at the head of the canal, 19 miles below the reservoir site.

The reservoir is formed by a masonry dam having the following general dimensions:

Length of dam, . . . . .	4067 feet.
Maximum height above foundation, . . . . .	130 "
Top-width, . . . . .	12 "
Bottom-width, . . . . .	73.7 "

The maxima pressures in the masonry are:

At down-stream face, . . . . .	5.8 tons per square foot.
At up-stream face, . . . . .	6.7 " " " "

The profile of the dam was determined by a modern formula, similar to that of M. Bouvier's.

The catchment basin above the dam contains 128 square miles.

Waste-weirs, having a total length of 810 feet, are constructed in the body of the main dam, at both ends. They can pass a depth of water of 8 feet. The roadway is carried over the weirs by a series of arches having spans of 10 feet.

To pass the floods, which amount, at times, to 50,000 cubic feet per second, there are, in addition to the waste-weirs, twenty under-slucices, 4 × 8 feet in area, having their sills 60 feet below high-water mark.

With this great head, the sluices can discharge 20,000 cubic feet per second, the average flood.

The sluice-openings are lined with the best ashlar masonry, and are closed by iron gates, which slide vertically and are operated by steel screws, worked from the top of the dam by a female capstan-screw turned by hand levers.

\* XIIth Annual Report of the U. S. Geological Survey. Irrigation in India, by Herbert M. Wilson. Engineering Record, December 19, 1891, and July 30, 1892.

The main object of the sluices is to discharge the water from the reservoir into the river in which it flows about 20 miles to the diversion-weir at the head of the Nira canal. A less number of sluices would have been sufficient for this purpose, the object of having so many being to prevent the silting up of the reservoir. This can only be accomplished by keeping all of the sluices partially open, when the river carries much sediment.

In this connection, Mr. A. Hill, the superintending engineer, states:

"Scouring sluices have little effect unless the area of the openings is great compared to the area of the floods. To remove silt already deposited they are useless, as has been proved by the manner in which they have silted up at Lake Fife and at Vir and other places where their area is small compared with that of the area of the floods. At Bhatgur they are intended not to remove silt deposited already, but to prevent its deposit by carrying it off while in suspension. If the dam is high and the discharge of the under-sluices will keep the flood level below the full-supply level, then they will be efficient. If the dam is low and the sluices will not keep the flood level below full-supply level, they will have little effect."

Automatic sluice-gates 8 feet by 10 feet, patented by Mr. E. K. Reinold, are to be placed on the waste-weirs. They will be arranged so as to be wide open when the floods reach a level of 8 feet below the crest of the dam, and to close gradually as the water lowers.

**The Betwa Dam\*** has been built recently across the valley of the Betwa River, an affluent of the Jumna River, in India, to divert its water into an irrigation canal, and to form a large storage reservoir, having a capacity of 1,603,000,000 cubic feet.

Water is supplied in this manner to about 150,000 acres of land, which are contained in a region which has an annual rainfall of only 35 inches.

The Betwa project was first proposed by General Strachey in 1855. It was investigated by various engineers from time to time, but the plans were not finally approved by the Government until 1873.

The flow of the Betwa River varies from 50 cubic feet per second to 750,000. To pass the large quantity of water in time of freshets, the whole dam was built as an overfall weir. It was skilfully located at a wide part of the river, where a rocky ledge offered a good foundation.

The total length of the dam is 3296 feet, its height varying from 0.4 feet to 60 feet. The plan is convex up-stream. Two islands divide the weir into three parts.

As originally proposed, the dam was to have a top-width of 10.5 feet and a slope on both faces of 10 feet horizontal for 25½ feet vertical. The Chief Engineer, Col. Greathed, changed the plan, however, so as to make the top-width 15 feet and the down-stream face nearly vertical, so that 6 inches depth of water would pass over the weir without falling on the face of the dam. The dam was made excessively strong, its bottom-width being greater than its height.

A water cushion was formed in front of the weir, by building a subsidiary dam,

---

\* XIIth Annual Report of the U. S. Geological Survey. Irrigation in India, by Herbert M. Wilson.

having a maximum height of 18 feet, about 1,400 feet down-stream from the main structure, across the channel of the river.

Below the water, thus backed up against the dam, a large block of masonry 15 feet wide by about 20 feet high was constructed in front of the dam.

The body of the dam was built of rubble masonry, coursed at both faces and laid in native hydraulic-lime cement. The coping was made of granite ashlar, 18 inches thick, laid in Portland-cement mortar.

The dam is provided with suitable sluices for scouring the reservoir and for controlling the flow into the canal.

**The Periar Dam** (Plate LVIII) was constructed in 1888-98 across the Periar River,\* in the Province of Madras, India, to form a reservoir of about 13,100,000,000 cubic feet capacity for irrigating purposes. The water is conveyed into the valley of the Vigay River by means of a tunnel 6,650 feet long, having an area of 80 square feet, and is used for irrigating about 140,000 acres of land.

The project of diverting water from the Periar River to the Vigay Valley was considered as early as 1808 by Sir James Caldwell, who rejected the scheme as unworthy of consideration.

In 1867 Major Ryves revived the project and made a report recommending the construction of an earthen dam, 162 feet high, across the Periar River. Colonel Pennycuik, who was given full charge of the project in 1868, proposed the construction of a masonry dam instead of one of earth, and worked out the details of the plans that were finally adopted. The cost of the reservoir, tunnel, and auxiliary works was estimated at \$3,220,000.

The construction of the masonry dam was commenced in 1888 and was completed in 1897. The profile adopted for the dam is shown on Plate LVIII. It was based on the conditions that the lines of pressure, reservoir full or empty, should be kept within the centre third of the profile, and that the maxima pressures, at the back or front face of the dam, should never exceed 18,000 lbs. per square foot, calculated by M. Bouvier's formulæ.

Owing to the difficulty experienced in obtaining skilled masons, it was determined to build the dam of concrete formed of 25 parts of hydraulic lime, 30 of sand, and 100 of broken stone. Both faces of the dam, however, were to be constructed of uncoursed rubble.

The ingredients of the concrete were mixed mechanically by means of turbine wheels. The lime used was obtained from a quarry situated about 16 miles from the dam, and was of excellent quality, being about equal to the well-known "Theil lime" which was used for the large masonry dams near St. Etienne, France.

Good, sharp, syenitic sand was found in the river-bed.

Most of the stone for the masonry was obtained from the excavations made in connection with this work. About 185,000 cubic yards of masonry was required for the dam.

There are two waste-ways, one on each bank of the river, for which depressions in the hills will be used. They aggregate 920 feet in length.

---

\* Written also "Periyar River."

The construction of the Periar Dam involved unusual difficulties, the work on the foundations having been limited to the three dry months January, February, and March. From the end of May to the beginning of December the ordinary flow of the Periar River is about 4000 cubic feet per second. In January the discharge commences to diminish very much and amounts to only about 250 cubic feet per second. During February and March it is even less. The drainage area back of the dam is 300 square miles, on which annually 65-200 inches of rain fall, the average being about 125 inches. The depth of water flowing off the shed is about 49 inches yearly.

But the flow of water in the river was not the only difficulty to be overcome. From the end of March to the beginning of June the malaria is deadly. Some idea of the difficulties involved in this construction may be formed from the following extract of a letter written by Colonel Pennycuik, the Chief Engineer of the work, to the writer in April 1890:

"The peculiarity of this work is not so much the actual height of the dam (173 feet), as the combination of height with the size of the river, the discharge of which rises to over 120,000 cubic feet per second at times, and the peculiar conditions of the site, which is in a jungle inhabited by nothing but elephants, bison, and tigers, seventeen miles from the nearest habitation, and eighty-three from the nearest railway station. Labor has to be paid for at appalling rates, and the country bears a bad name for fever, of which the natives are much afraid. We have, in fact, to stop work entirely on that account for three months, and those the best of the year for river work; add to this that except in February and March you cannot be certain of a fortnight, at a time, without a flood, and that it is an every-day occurrence for the discharge to rise in a few hours from 500 cubic feet per second to 4000 or more, and you will understand that putting a dam across a river of this kind is not an easy job."

For a full account of how the difficulties involved in building the foundation of the Periar Dam were overcome we refer the reader to a series of articles on this subject by A. T. Mackenzie, A.M.I.C.E., in "Engineering" for 1892, and to a condensed account in "Engineering Record" of December 31, 1892. See also "the XIIth Annual Report of the U. S. Geological Survey. Irrigation in India, by Herbert M. Wilson."

**The Beetaloo Dam,\*** in South Australia, was constructed in 1888-1890 to form a reservoir of 800,000,000 imperial gallons' capacity for impounding water for the domestic water-supply and irrigation needs of a district of 1715 square miles, including several towns.

The water is distributed by 255 miles of pipes 2-18 inches in diameter.

The dam was constructed entirely of concrete mixed by machinery, the total quantity required being about 60,000 cubic yards.

---

\* *Engineering News*, May 30, 1891, and September 19, 1891.

Its general dimensions are as follows:

Maximum height, . . . . .	110 feet.
Width at top, . . . . .	14 "
"    " bottom, . . . . .	110 "
Length at top, . . . . .	580 "
Spillway 200 feet long by 5 feet deep.	

The plan was curved to a radius of 1414 feet. The profile adopted for the dam was Prof. Rankine's Logarithmic type (see Plate III). The masonry was founded entirely on rock.

The reservoir formed has a length of  $1\frac{1}{4}$  miles, an average width of 530 feet, and a depth at the dam of 105 feet.

The work was begun in February 1888 and completed in October 1890, the total cost being \$570,000. Mr. A. B. Moncrieff was Chief Engineer.

The Geelong Dam\* (Plate LIX.)—This dam was built across the valley of Stony Creek to form a reservoir for the water-supply of Victoria, Australia. It is built on a curvilinear plan, the radius of the vertical part of the back face being 300 feet.

The masonry consists entirely of concrete, as it was thought to be cheaper than rubble, and also to form a more perfect monolith. The concrete was made of broken sandstone, mixed in a puddling-mill with hydraulic mortar which was composed of Portland cement and pit-sand. The best results were obtained by mixing the ingredients in the following proportions:

2" stone, . . . . .	4 $\frac{1}{2}$ parts.
Screenings, . . . . .	1 $\frac{1}{2}$ "
Sand, . . . . .	1 $\frac{1}{2}$ "
Cement, . . . . .	1 "
Total, . . . . .	8 $\frac{1}{2}$ parts.

The stone of which the concrete was made weighed about 163 pounds per cubic foot. The average weight of the concrete was 143 pounds per cubic foot.

The cement and sand were mixed dry, then made into mortar and thrown over the broken stone. Great pains were taken to place the concrete before the cement commenced to set. The work was carried up in courses a few inches thick, each course being rammed until the mortar flushed the surface. Before commencing a new course the surface of the preceding one was well watered and mopped over with cement grout immediately in advance of the new concrete.

The Geelong Dam is coped with heavy blue stones, which are 3' 3" wide by 1' 9" deep. Although waves four feet high break over the top of the dam, not the slightest damage is apparent.

Two pipes, 24" diameter, pass through the dam: one serves for the "outlet," and

\* Proc. Inst. C. E., vol. lvi., p. 93.



the other, which is placed at a lower level, to scour the reservoir. Both pipes have stop-cocks on the down-stream side of the dam.

When the Geelong reservoir was first filled, a little water found its way through the dam; but this leakage soon stopped, owing to hard incrustations of lime being formed on the dam.

**The Tytam Dam** (Plate LX) \* was constructed near Hong Kong, about 1887, for the Tytam Water Works. The foundation was laid on decomposed granite and boulders, as solid rock could not be found without going to a great depth. Owing to the difficulty of securing skilled masons for this work, it was decided to build the dam of stones about 3 to 6 cubic feet in size, laid in a matrix of concrete. The wall was constructed in the following manner:

The inner face was composed of ashlar masonry of granite, laid in courses one foot high with plenty of headers. The side joints of the stones were grouted, the mortar being composed of 1 part Portland cement to 2 parts of sand. Next to the inner face 2 feet of "extra fine" concrete, composed of 4 parts of stone (1" cubes), 6 parts of sand, and 2½ parts of Portland cement, was placed in order to form a water-tight skin. Next came 5 feet of "fine concrete," composed of 4½ parts of stone, 3½ parts of sand, and 1 part of Portland cement. The "hearting" of the wall consists of "fine concrete" mixed as above, with stones 3 to 6 cubic feet in size imbedded in it. These stones were not placed closer than 3 inches from each other, the spaces between them being filled with concrete, which is well rammed. The outer face was carried up in steps for convenience of getting across the valley. It was not built exactly as shown in Plate LX. The facing is only one stone thick, and has its back irregular so as to bond with the concrete.

The dam was constructed in courses about 2 feet thick, and inclined up-stream so that the front face was about 2½ feet higher than the back face. Each course had plenty of projecting stones to bond it with the next one.

After the outer facing and the rubble-concrete hearting of a course had been laid, the "fine concrete" was placed between this masonry and planks. The back face was then carried up, and finally the "extra fine" concrete was rammed between this face and the "fine concrete." About three fifths of the bulk of the whole wall consists of concrete and two fifths of stone. The best London Portland cement was used, about one barrel of cement being required per cubic yard of masonry.

The stone for the concrete was crushed to pass through a 1¼" hole by machinery, and was mixed with the mortar in revolving cylinders. The screenings from the "crusher" were used as sand, this article being very scarce. The river sand used was not washed, as the clay, or rather decomposed granite, it contained was considered an advantage as conducing to water-tightness. For the same reason the engineers in charge of this work used plenty of sand in the concrete, and took care not to have it too sharp or clean, the object being not so much to obtain strength as to make the mortar impervious.

The foundation of the dam was prepared in the following manner: After cleaning the surface of decomposed rock and boulders thoroughly, liquid cement mortar, mixed 3 to 1, was spread over it; then 3 inches of stiffer mortar was placed. Before this mortar could dry, 18 inches of "extra fine" concrete was laid, then 3 feet of fine concrete, and finally the rubble blocks.

---

\* This description was written in 1887.

To allow any water that might leak into the wall to escape freely, perforated zinc pipes  $1\frac{1}{2}$  inches diameter were placed in the masonry about 5 feet apart, and later on only bamboos; but this precaution was hardly necessary. When the water had risen to the top of the fourth step, the leakage could be carried off by a one-inch pipe without pressure.

The water will be taken from the reservoir by means of a valve-well having inlets at different elevations. The well is placed at the centre of the dam, which is reinforced at this point by a pier. A cast-iron midfeather divides the well into halves, one being full of water and the other dry. The valves are placed in the dry part.

The description of the Tytam Dam which we have given above has been taken from a letter of Mr. James Orange, the engineer in charge of the work, addressed to Mr. B. S. Church, Chief Engineer of the New Croton Aqueduct, to whom we are indebted for this information.

The Toolsee Dam,\* was built according to the logarithmic profile designed by Prof. Rankine (see Plate III), its total height above bed-rock being 79 feet. It forms a lake for the water-supply of Bombay.

The Meer Allum Dam,† India, was constructed about 1800 to form a reservoir, known as Meer Allum Lake, from which the city of Hyderabad draws its water-supply. The

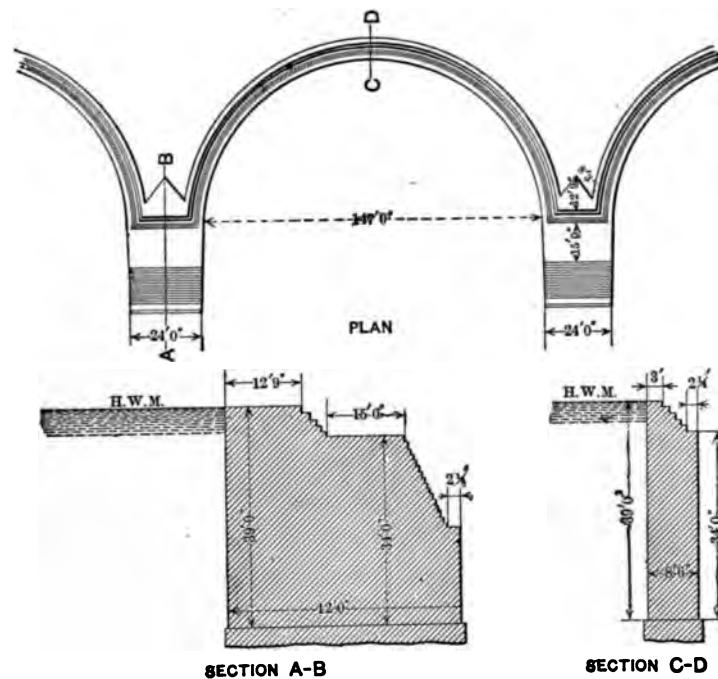


FIG. 31.—MEER ALLUM DAM.

reservoir covers about 900 acres of land and stores about 2,123,000,000 gallons of water. The greatest depth of water in the reservoir is about 50 feet.

\* Spon's Dictionary of Engineering. Vol. VIII, p. 2743.

† The description of the Meer Allum Dam and Fig. 31 are taken from "Irrigation Engineering," by H. M. Wilson, M. Am. Soc. C. E. See also *Engineering Record*, January 10, 1903.

The watershed of the reservoir is hilly and undulating and is well covered with jungle. The main feeder of the lake takes its rise from the river Esee and is about eight miles long.

The dam, which forms in plan a large arch about half a mile long, consists of 21 smaller arches or scallops, which transmit the water pressure to solid-masonry buttresses. The small arches or scallops have spans of 70-147 feet. Fig. 31 shows the largest of these spans, which is built in the centre of the dam. Both faces of the arch are vertical except near the top, where the thickness of the arch is reduced from  $8\frac{1}{2}$  feet to 3 feet by steps.

A waste-weir is constructed at one end of the dam, but is insufficient to discharge the water flowing into the reservoir during heavy rainstorms. In such cases about one or two inches of water flows over the crest of the dam.

**The Belubula Dam**, New South Wales,\* was built about 1898, across the Belubula River, to form a reservoir for storing water and furnishing power for the Lyndhurst-Goldfields Company of New South Wales. The dam is located in a narrow gorge, just above a succession of falls having a total descent of 175 feet. The valley above this gorge is of such width and slope that 16 feet of water stores about 652,000,000 gallons and gives a head of nearly 200 feet for turbines that are located about half a mile below the dam.

The rock at the site of the dam lies in a number of sharp ridges parallel with the axis of the stream with deep channels between. To have built an ordinary masonry wall in such a location would have involved expensive foundation work. Mr. Oscar Schulze, C.E., of Sydney, who designed the work and directed its execution, decided therefore to construct a buttressed wall, to be built largely of brick, as this was the cheapest available material in that locality.

The dam has a total crest length, including the waste-weir, of 431 feet and a maximum height of 60 feet. The foundation is laid in concrete, varying in height from 1 to 23 feet, and above this there is 36 feet 9 inches of brickwork. In the central part of the dam there are six buttresses of brickwork, 28 feet apart, centre to centre, which form piers for five elliptical brick arches which are 4 feet thick at the bottom, 1 foot 7 inches thick at the top, and lean down-stream at an angle of  $60^\circ$ . The buttresses are 40 feet long, 12 feet wide where they abut against the wall, and 5 feet wide at the outer end. Each buttress, as it is carried up, forms a segment of a circle of 36 feet 2 inches radius and it diminishes in thickness from  $8\frac{1}{2}$  feet at the centre to 4 feet at the outer circumference.

The spandrels between the arches are filled with concrete which covers the crown of the arches to a depth of 12 inches and joins the side walls of the dam, which are built of concrete in which large boulders were placed to save expense.

The overflow, which is constructed at one end of a side wall, is 65 feet wide. It is divided by piers into five sluiceways. Provision is also made for passing water over the tops of the arches in cases of high floods. During the construction the river flowed through an arched outlet at the base of the dam, which has been fitted as an emergency outlet for the reservoir by building out a projection on the water face of the dam, in which

---

\* *Engineering News*, September 8, 1898.

a well is constructed. This well is covered by a 12-inch wooden lid that can be raised by a 50-ton hydraulic ram, which is worked by a pump at the back of the wall.

The dam has a 12-inch outlet-pipe and two 6-inch scour-pipes, which are carried through the dam.

**The Barossa Dam,\*** South Australia, Fig. 32, was constructed in 1899-1903 to form a reservoir for supplying the town of Gawler, South Australia, and the surrounding farming district with water.

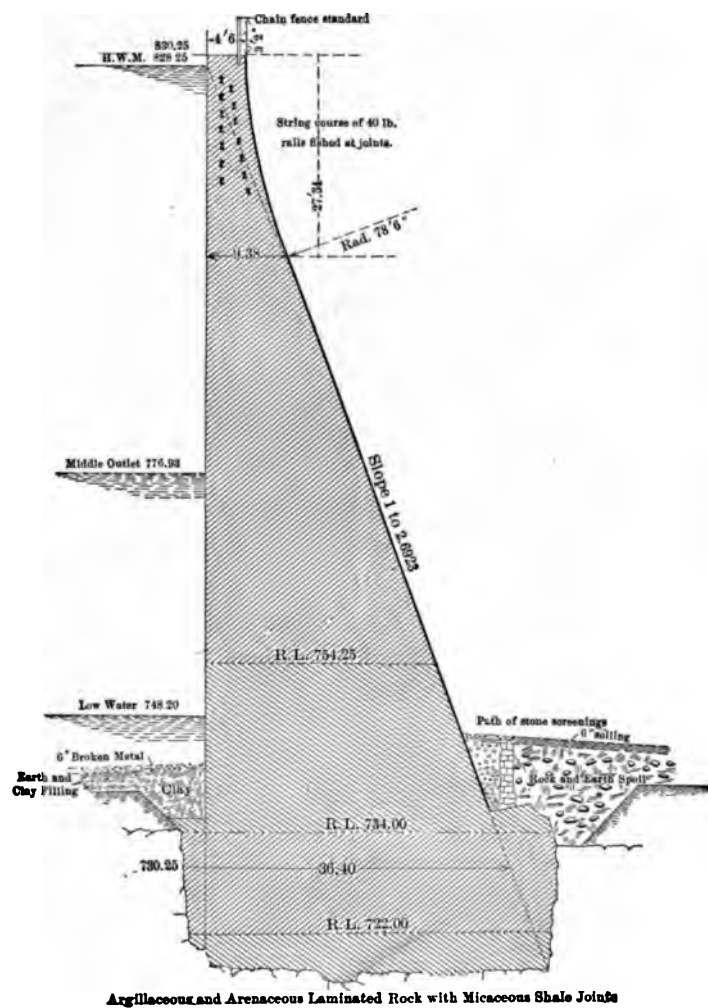


FIG. 32.—BAROSSA DAM.

The dam is located in a narrow valley with a steep rock cliff, about 100 feet high on one side and a gently sloping spur of the range on the other side. The dam was built of concrete on a curved plan, the radius of the up-stream side of the top of the dam being 200 feet. It is  $4\frac{1}{2}$  feet wide at the top and the greatest thickness of the concrete above the line of the foundation is 34 feet at the ground-line. The dam has a height of 95 feet above the bed of the creek across which it is built, the maximum height above the

\* *Engineering News*, April 7, 1904.

foundation being 112 feet. It was founded entirely on rock which was carefully stepped for the reception of the thrust of the arch into the wall on both sides.

The profile adopted for the dam is of the triangular type (Fig. 32), the section being considerably reduced from a "gravity section" on account of the dam's being built on a curved plan.

Great pains were taken to establish by experiments the best proportions for the ingredients of the concrete. After the concrete had been brought to the natural surface moulding timbers were introduced, which were hung on bolts built into the wall at every four feet vertical. Before inserting these bolts, they were covered with paper from the cement casks and tied around with cotton, which facilitated their removal from the wall. After the bolts and the paper were withdrawn, the holes were washed clean and filled with mortar. In the upper 15 feet of the wall string courses of iron tram-rails were built in horizontally, 40 tons being used.

The dam was completed in February, 1903, but the reservoir was not completely filled until September, 1903. The atmospheric temperature during the construction varied from 30° to 168° F.

**The Cataract Dam, New South Wales,\*** has been under construction since October, 1902, and is to be completed during the year 1907. It will form a reservoir of 21,000,000,000 imperial gallons capacity for the water-supply of Sydney.

The dam will be 811 feet long and 16 feet wide on top, 194 feet high above bed-rock, and 158 feet wide at the base. Its plan is straight. The maximum depth of water in the reservoir will be 148 feet. The heart of the dam is being built of large blocks of sandstone, laid in Portland-cement mortar, the joints being filled with concrete. This masonry is faced on the up-stream side with concrete blocks (about  $5 \times 2\frac{1}{2} \times 2$  feet in size) made of crushed bluestone or basalt and Portland-cement mortar. The blocks are backed by about 3 feet of bluestone concrete. On the down-stream side the dam is faced with concrete, about 6 feet thick. Drains are placed in the body of the dam and will discharge the seepage water at the down-stream face.

A waste-weir 720 feet long is provided, its crest being 7 feet below the top of the dam. Four 48-inch pipes provided with suitable valves were laid in the dam and discharged the river during the construction. Two of these pipes will form the permanent outlet of the reservoir.

---

\* *Engineering Record*, November 5, 1904, and April 20, 1907; *Engineering News*, December 6, 1906.

## CHAPTER XIII.

## AMERICAN DAMS.

**The Boyd's Corners Dam\*** (Plate LXI.) was constructed on the west branch of the Croton River, to form a storage reservoir having a capacity of 2,722,720,000 gallons for the city of New York. The reservoir has a surface of 279 acres, the maximum depth of the water being 57 feet. The general dimensions of the dam are:

Length on top, . . . . .	670.0 feet.
“ at level of the river, . . . . .	200.0 “
Maximum height above foundation, . . . . .	78.0 “
Width at top, . . . . .	8.6 “
“ “ base, . . . . .	57.0 “

Plate LXI. shows the profile of the dam as designed by the Chief Engineer, Geo. S. Greene. It was built with cut-stone facings, and a hearting of concrete into which large stones were placed from the base to 15 feet above the stream. The concrete was mixed in the proportion of  $4\frac{1}{2}$  parts of stone, 2 of sand and 1 of cement. It weighed 133 $\frac{1}{2}$  pounds per cubic foot.

Water is drawn from the reservoir by means of a tower having two 36-inch outlet-pipes which pass through the dam. The overflow is about 100 feet long, and was formed by excavating the rock at the north-east end of the dam.

The work was done originally under the direction of "The Croton Aqueduct Board." However, in 1870, when the dam was almost completed, the control of the work was transferred to the Department of Public Works. The new authorities changed the plans by building against the up-stream face of the dam an earthen bank 20 feet wide on top and having a slope of 5 to 2. According to Mr. J. J. R. Croes, the engineer in charge of the construction of the dam, this embankment was built of porous material which would not puddle well. "It was built by contract, and not rolled or thoroughly rammed, but merely carted over."

Under these circumstances the earthen embankment must have become saturated, subjecting thereby the dam to an increased pressure instead of reinforcing it.

The work was commenced in September, 1866, and completed in the fall of 1872. The masonry dam contains about 21,000 cubic yards of concrete and 6000 cubic yards of cut stone.

**The Bridgeport Dam†** (Plate LXII.). This dam was built across the Mill River at a point  $5\frac{1}{4}$  miles from Bridgeport, to form a new storage reservoir for the water-supply of that town. The general dimensions of the dam are:

Length on top, . . . . .	640 feet.
“ at bottom of stream, . . . . .	50 “
Maximum height, . . . . .	40 “

The west end of the dam forms an overflow-weir 80 feet long, being 5 feet below the guard-wall.

\* See "Memoir on the Construction of a Masonry Dam," by J. J. R. Croes, C.E., in the Papers of the American Society of Civil Engineers for 1874.

† *Engineering News*, April 9, 1897.

The scouring-gallery is 3 feet 4 inches by 3 feet 4 inches in the clear, and is closed by a suitable gate, which is operated by worm gearing.

A gate-chamber 10 feet by 15 feet in the clear, lined with 12 inches of brick, is built against the dam, the back of which forms one side of the chamber. The other sides consist of rubble walls 7 feet thick at the base and 3 feet at the top. The chamber is divided into two partitions by means of two walls, projecting 2 feet 10 inches, between which a fish-screen is placed.

Three openings, 30 inches in diameter and located at different heights, serve as the inlet to the gate-chamber. Each opening is provided with a suitable gate. After passing through the screen, the water is drawn from the reservoir by means of a 30-inch cast-iron outlet-pipe, having a stop-cock in the gate-chamber.

The wall was founded entirely on rock, and was built of rubble masonry made of gneiss rock and hydraulic mortar consisting of 1 part of Rosendale cement to 2 parts of sand.

The area of the reservoir is about 60 acres, and its capacity, 240,000,000 gallons.

The original plan was of the Krantz type, as indicated by the dotted line in Plate LVI.; the dam was built, however, in steps, as shown. When the reservoir was first filled, the dam proved to be very pervious, and it has therefore been proposed to build an earthen embankment of 50 feet base at the lowest point of the valley and extending within 10 feet of the overflow against the up-stream face of the wall.

Messrs. Hull and Palmer are the engineers who designed and executed this work.

**The Wigwam Dam,\*** Plate LXIII, was built in 1893 to 1903 to form a new reservoir of 735,000,000 gallons capacity for the water-supply of the city of Waterbury, Connecticut. The watershed supplying the reservoir contains 18 square miles.

The dam is located at the junction of the West Branch of the Naugatuck River with Fenn Brook. The valley at this point is only 80 feet wide at the bottom and 600 feet at 75 feet above the river-bed. The dam is founded entirely on rock. Its central part is curved to a radius of 600 feet on a chord of 391 feet, and the ends, which are only under a pressure of 20 feet of water, are made straight on the extension of the chord of the curved part.

The dam has a maximum height of 91 feet above the foundation. The top width is 12 feet. The body of the dam is formed of rubble masonry, which is faced on both sides with broken ashlar of granite averaging 30 inches in thickness. The facing stones are set normal to the line of pressure. The cement used was Portland, mixed 2:1 for the foundation and 3:1 elsewhere, with the exception of some Rosendale 2:1 in the interior of the heavy part of the wall.

Water is drawn from the reservoir through two 30-inch cast-iron outlet-pipes that pass through the dam. The flow through these pipes is regulated in a gate-house that is built in the up-stream side of the dam. This gate-house is divided into two compartments, or wells, one for each pipe-line. Each compartment has an inlet at its bottom, 55 feet below the flow-line of the reservoir. Higher inlets are provided 11 feet apart and are alternated between the compartments. Each of the wells can be drained out into the old brook channel. Vertical screens, 5 feet wide, of copper wire in wood frames extend from the top to the bottom of each well. At the down-stream end of the outlet-pipes a gate-

---

\* *Engineering News*, May 7, 1903.

house is placed, where either pipe-line or both may be used to supply the 36-inch pipe-line leading to the city. Immediately below the gate-house a 36-inch Venturi meter is placed for recording the water supplied to the city.

At the north end of the dam there is a waste-weir 48 feet long over which the roadway is carried on three flat masonry arches. The main overflow is at another part of the reservoir, this weir securing better circulation near the intake. The top of the dam is finished with heavy granite coping, carrying a railing, and a granolithic roadway.

The construction was begun in the spring of 1893 and all work done that year was by the day. In the winter of 1893-4 contracts were let for completing all work required to impound water to a level of 15 feet below the flow-line adopted for a full reservoir. These contracts were executed and a regular supply was furnished in January 1896. In 1901-02 the dam was built up to the full height contemplated in the plans.

In addition to the masonry dam an earth dam with a concrete core-wall was constructed at a depression known as the South Gap, to retain the water in the reservoir. It has a maximum height of 35 feet and a length of 600 feet. At the north end of this dam an overflow 170 feet long was made in rock. The top of the earth dam is 9 feet above this spillway and  $2\frac{1}{2}$  feet above the crest of the masonry dam.

The works were planned and executed under the direction of R. A. Cairns, M. Am. Soc. C. E., City Engineer of Waterbury.

**The San Mateo Dam\*** (Plate LXIV) was built in 1887 and 1888 near San Mateo, California, to form a storage reservoir for the water-supply of San Francisco. This reservoir has covered the old Crystal Springs reservoir from which the city was formerly supplied.

The plans originally contemplated building a masonry dam 170 feet high which would store about 31,000,000,000 U. S. gallons. The top-width of the dam was to be 25 feet. At present the dam has only been carried up to a height of 146 feet, as the storage thus obtained is sufficient for the present demand. Its greatest bottom-width is 176 feet. The dam has been curved up-stream to a radius of 637 feet. At the 170-foot level it will have a length of 680 feet.

As no rock suitable for rubble masonry could be found in the vicinity of the work the dam has been entirely built of concrete made with Portland cement mortar, mixed in the following proportions: 22 cubic feet of broken stone, one barrel of Portland cement, and two barrels of sand. The stone used was quarried in small nodules, which were frequently covered with clay and serpentine. It was crushed by machinery and passed through revolving iron cylinders, where it was thoroughly washed by jets of water. All the sand required for the masonry had to be brought from the dunes of North Beach near San Francisco, a distance of about 32 miles. It was first transported in cars a distance of about a mile to barges, towed up the bay for a distance of about 25 miles to a landing opposite San Mateo, and then hauled in wagons to the dam for a distance of 6 miles.

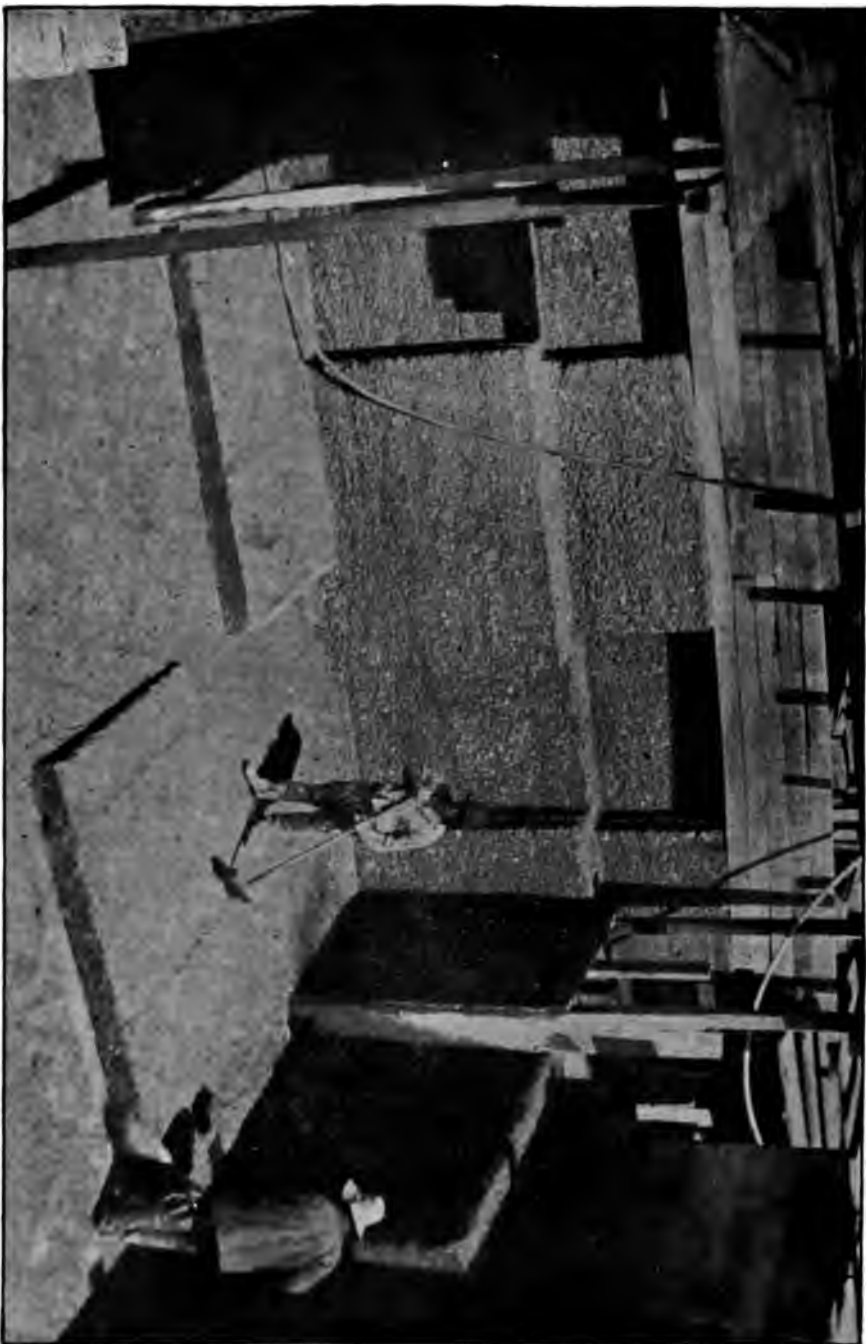
The concrete was mixed in six cubical iron boxes revolved by steam, and was delivered to the work in small cars which were pushed by hand over a double-track tramway. At the dam the tramway was carried on a trestle, built at the top level of the wall, and carried half-way across the valley. The concrete was delivered to

---

\* Eighteenth Annual Report of the U. S. Geological Survey, Part IV.



PLATE I.



SAN MATEO DAM.  
Roughening Surface of Concrete Blocks to Receive Fresh Cement.  
(From "Eighteenth Annual Report of U. S. Geological Survey.")





PLATE J.



BEAR VALLEY DAM.

(From "Eighteenth Annual Report U. S. Geological Survey.")



platforms on the wall through vertical pipes, 16 inches in diameter, which were placed at intervals between the rails of the track. The height from which the concrete was dropped was at times as much as 120 feet, but no injury was done.

The concrete was placed in the dam in large moulds, forming blocks that contained from 200 to 300 cubic feet. These blocks had numerous offsets and were dovetailed together in an ingenious manner. They have been so well bonded in every direction that the dam forms almost a monolith. Since the reservoir has been filled the only signs of any leakage have been a few damp spots in the front face.

The outlet from the reservoir consists of a 54-inch riveted iron pipe, which is laid in a rock tunnel 390 feet long, which was driven through a hill on the north side of the channel. This tunnel is lined throughout with 4 courses of brick and is  $7\frac{1}{2}$  feet high by  $7\frac{1}{2}$  feet wide inside of the lining. A brick-lined shaft 14 feet in inner diameter, placed in the reservoir just inside of the dam, intersects the tunnel. Inside of this shaft there is a stand-pipe connecting with the main outlet-pipe. Three branch tunnels are driven from the shaft at different elevations to the reservoir. In each of these branch tunnels a pipe, controlled in the shaft by a gate-valve, is laid and connected with the stand-pipe. The ends of the tunnels under water have plain cover-valves over elbows and are provided with fish-screens that are put into position from floating barges. A 44-inch pipe is laid from the outlet-pipe to San Francisco.

**The Bear Valley Dam** (Plate LXV) was constructed in 1884 in the Bernardino Mountains in California to form a large reservoir for irrigation purposes. As all the cement, tools, and supplies had to be hauled for about 70 miles over rough mountain roads to the site of the dam, and the available financial means were very restricted, the engineer in charge of the work, F. E. Brown, C.E., designed a structure which surpasses in boldness all other dams built. The profile adopted is so thin that the dam cannot resist the thrust of the water by gravity. It owes its stability solely to the curved form of its plan, which enables the wall to act as an arch. Assuming the weight of the masonry at 166.7 pounds per cubic foot (corresponding to a specific gravity of  $2\frac{2}{3}$ ) we find that the line of pressure, reservoir full, lies almost entirely outside of the profile.

The work was commenced in the summer of 1883 by the construction of an earthen dam, 6 feet high, about  $2\frac{1}{2}$  miles above the site selected for the masonry dam. This dam retained all the water in the stream during the construction, causing it to overflow about 450 acres of land. The masonry dam was built during the latter half of 1884. It was founded on rock and constructed of a rough granite ashlar with a hearting of rubble, all laid in Portland-cement mortar or grout. A barrel of this cement delivered at the dam cost \$14 to \$15, of which amount \$10 was for haulage.

The dam is curved up-stream with a radius of 335 feet, and is about 300 feet long on the crest. Its maximum height is 64 feet. The masonry was carefully laid, the leakage through the dam, when the reservoir was filled, amounting only to a sweating.

The outlet from the reservoir is controlled by a 20×24-inch iron sluice-gate which lets the water into a 2×3-foot culvert built in the bed-rock. The sluice-gate is operated from the top of the dam by a stem passing through a 6-inch vertical pipe.

A waste-weir, 20 feet wide, was excavated in the rock at the south end of the dam

to a depth of 8.5 feet below the level of the crest of the dam. It is provided with flash-boards.

The amount of water stored in the reservoir is 1,742,400,000 cubic feet. It is supplied by a watershed of about 56 square miles.

The irrigation company which built the dam intended to replace this rather dangerous structure by a more substantial rock-filled dam, to be built about 200 feet farther down-stream. This dam was to have a height of 80 feet. Its foundation was laid in 1893, but nothing more was done in the construction.

**The Sweetwater Dam** (Plate LXVI).—This dam was constructed in San Diego County California, by the San Diego Land and Town Company, for storing water for irrigating large tracts of land and for supplying water to National City. The flow of the Sweetwater River, from which water was to be impounded, varies from 1 to 2 cubic feet per second during the dry seasons of the year to 1000 cubic feet per second during periods of freshets.

The construction of the dam and reservoir was decided upon in November, 1886. According to the original plans, the wall was to be formed of concrete and to be 10 feet thick at the base, 3 feet thick at the top, and 50 feet high. On the up-stream side of this concrete dam an earthen bank was to be constructed. After about two months' work had been done Mr. James D. Schuyler, C.E., was given charge of the construction, and wisely modified the plans by deciding to build a substantial dam of rubble masonry, instead of a concrete wall reinforced by an earthen bank.

Owing to the great need of water, the dam was at first carried up to a height of 60 feet, with a profile shown by the dotted lines in Plate LXII. The reservoir thus formed had a storage capacity of 1,221,000,000 gallons. Subsequently the dam was built to a height of 98 feet, increasing the capacity of the reservoir to 5,882,000,000 gallons. The profile adopted is shown by the full lines in Plate LXII.

The principal dimensions of the dam are :

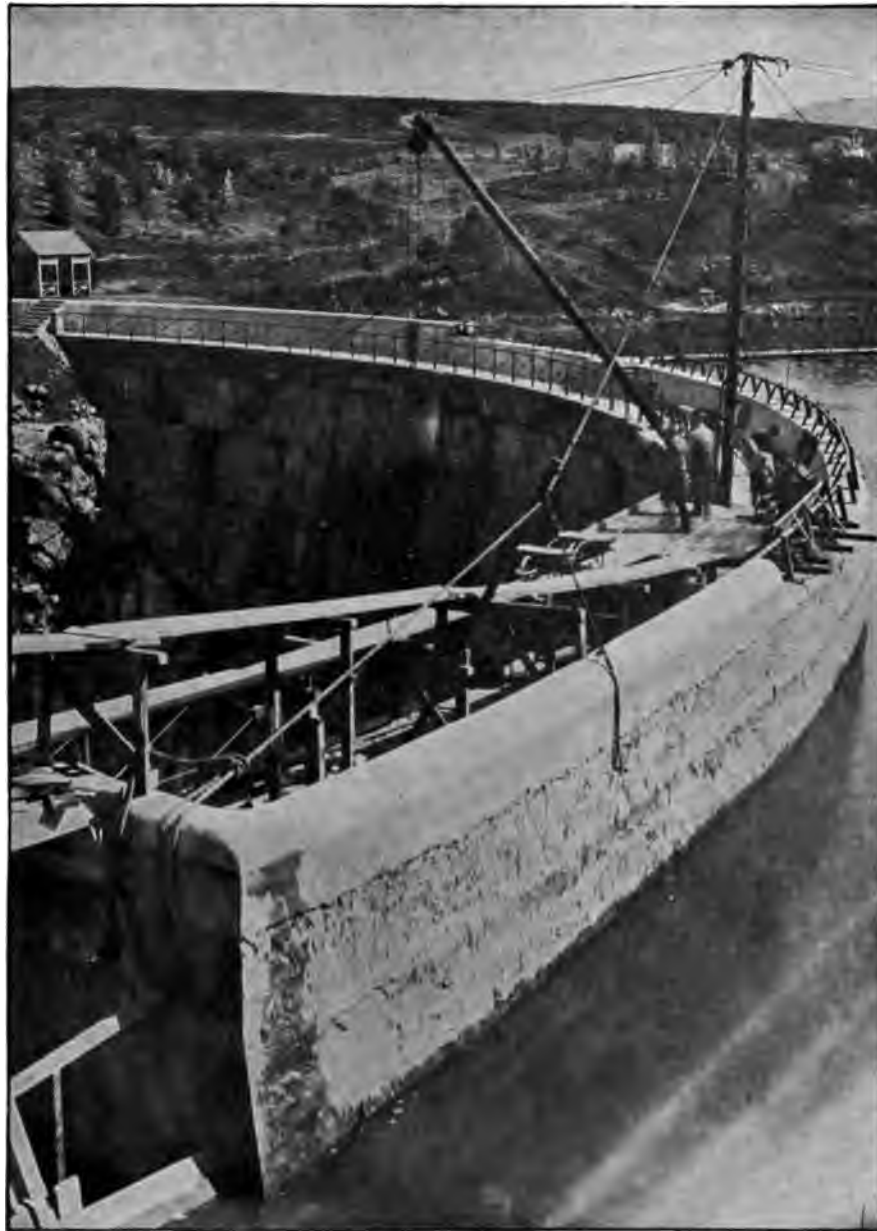
Length at top, . . . . .	380 feet.
Height, . . . . .	98 "
Width at top, . . . . .	12 "
Width at base, . . . . .	46 "

The up-stream face is carried up to within 6 feet of the top of the dam with a batter of 1 in 6. The batter of the down-stream face starts at the base with 1 in 3 for 28 feet, changes then to 1 in 4 for 32 feet, and remains then 1 in 6 to the coping.

The plan is curved, the radius at the top of the up-stream face being 222 feet. Considerable reliance was placed upon the additional strength obtained by curving the plan, as the line of pressure, reservoir full, would be only one sixth the width of the base from its down-stream toe, if the dam resisted simply by gravity.

The dam was founded on solid rock, which was carefully prepared for the masonry. The stone used was dark blue and gray metamorphic rock, impregnated with iron. It weighed about 175–200 lbs. per cubic foot. The quarry was about 800 feet down-stream from the dam. Portland cement of the best quality was used. It was mixed with clear, sharp river sand in a revolving, square iron box. The usual proportion for the mortar was 1 part of cement to 3 parts of sand; but for the masonry near the up-stream face of the dam only 2

PLATE K.



SWEETWATER DAM.—INCREASING THE HEIGHT OF THE PARAPET.  
(From "Eighteenth Annual Report U. S. Geological Survey.")





measures of sand were mixed with 1 of cement. The masonry weighed about 164 lbs. per cubic foot. It was all laid by means of four derricks, worked by horse-power.

Water is drawn from the reservoir by means of an inlet-tower, which is located 50 feet up-stream from the dam. It has seven inlet-valves, which are placed at different elevations. Three outlet-pipes, respectively 14", 18", and 36" in diameter, lead from the tower. They have gates on the down-stream side of the dam, by means of which the flow from the reservoir can be regulated.

The waste-weir is formed by part of the dam. It is 40 feet long and 5 feet deep. By means of piers, it is divided into 8 bays. The weir is calculated to discharge 1500 cubic feet of water per second. There is also a 30-inch blow-off pipe, which can discharge 300 cubic feet of water per second.

The Sweetwater Dam was finished April 7, 1888, the construction having required 16 months' time. The amount of masonry laid, including that in the inlet-tower, waste-weir, etc., was 20,507 cubic yards. The average amount of cement used was 1 barrel of cement to 1.17 cubic yards of masonry. The total cost of the work, which was constructed at a time when wages were very high in California, was \$234,074, not including the cost of the land.

We have taken the above description from the very complete and interesting paper on the Sweetwater Dam by Mr. James D. Schuyler, the engineer in charge of the work, which paper was read before the American Society of Civil Engineers on October 17, 1888.

Since the above account was written, the dam has been subjected to a very severe test during a flood caused by a rainfall of 6 inches in 24 hours. For 40 hours a sheet of water, 22 inches higher than the top of the parapet, flowed over the dam. The masonry of the dam withstood the strains it had to bear very successfully, not a stone being displaced, but great damage was caused to the outlet-pipes by the erosion of the water below the dam. The repairs required and some changes in the construction of the dam which were deemed advisable cost about \$30,000. The alterations made in the dam were as follows:\*

1. The parapet of the dam was raised 2 feet and strengthened so as to be able to hold the water permanently level with its crest. For 200 feet, however, the parapet was kept 2 feet lower so as to form a waste-weir, which was provided with iron frames for flashboards, by means of which the waste-weir can be raised to the level of the other part of the parapet.

The effect of this change has been to raise the high-water level in the reservoir 5.5 feet, which adds 25 per cent to the capacity of the reservoir.

2. The original spillway was extended by adding four more bays, each 5 feet wide. All of the bays were carried up to the new crest of the dam.

3. An unused tunnel, 8 × 12 feet in size, which had been excavated to draw down the water in the reservoir during a lawsuit about some of the land required for the reservoir, was utilized as an additional wasteway by placing two 48-inch and two 30-inch pipes in it. These pipes pass through a masonry bulkhead which was built in the tunnel at the reservoir. They are controlled by gate-valves placed in a shaft which reaches the surface.

4. The face of the rock slopes below the waste-channel from the overflow was covered with a grillage of iron rails embedded in concrete.

---

\* Eighteenth Annual Report of the U. S. Geological Survey, Part IV.

5. A concrete wall, 15 feet high, was built 50 feet down-stream from the dam and concentric therewith, in order to form a pond 5 to 10 feet deep which acts as a water-cushion for the overflow.

6. The main supply-pipe was replaced and protected through the canyon by means of concrete collars and spur-walls.

The profile of the Sweetwater Dam, while not as slender as those of the Zola and Bear Valley dams, is much holder than the types now usually adopted. During the flood mentioned above, the line of resistance, though still within the profile, was within a few feet of the outer toe. This must have caused some tension in the masonry at the up-stream face. The safety of the dam has doubtless been due to the excellent manner in which it was built and to the additional strength obtained by building it curved in plan.

**The La Grange Dam<sup>S\*</sup>** (called also the Turloch Dam), Fig. 33, was built in 1891-94 across the Tuolumne River, in California, to form a weir to divert water from the river into two canals which begin at the dam, one on each side of the valley. It was constructed in a narrow canyon that is only 80 feet wide at the level of the river-bed. The dam is

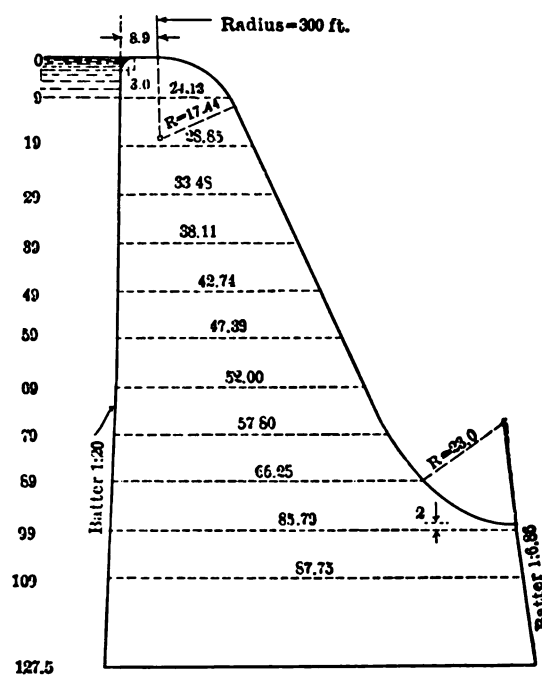


FIG. 33.—LA GRANGE DAM.

125 feet high at the up-stream face and 129 feet high above the down-stream toe. The dam is curved in plan to a radius of 300 feet. Its top and bottom widths are respectively

\*The descriptions marked "S" are taken principally from "Reservoirs for Irrigation, Water-power, and Domestic Water-supply," by James D. Schuyler, M. Am. Soc. C. E.

24 and 90 feet. The whole dam, which has a length of 310 feet on the crest, acts as an overflow-weir. During floods 46,000 cubic feet of water per second, corresponding to a depth of 12 feet of water on the crest, has passed over the dam. As no storage was contemplated, the dam is not provided with pipes. The canyon back of the dam will be allowed to fill with deposit. The dam was built of rubble masonry laid in Portland-cement concrete.

A subsidiary dam, 20 feet high and 120 feet long, was built about 200 feet below the main dam to form a pond 15 feet deep at the main dam, which acts as a water-cushion for the overflow.

The dam, which is the highest overflow-weir built to the present time, was designed by Luther Wagoner, C.E., and was built under the direction of E. H. Barton, engineer of the Turlock irrigation district, H. S. Crowe being in immediate charge of the work.

**The Folsom Dam**<sup>s</sup> (Fig. 34) was built in 1886-91 across the American River, in California, to furnish water-power and, also, to divert part of the river to the plains of the Sacramento Valley for irrigation. All of the work was performed by convict labor from one of the State prisons of California.

The dam was constructed at the top of a natural fall in the rock, and is 98 feet high on the down-stream face and only 69.5 feet high at the upper face. It is 87 feet thick at the base and 24 feet at the crest. This dam is about the only one of the struc-

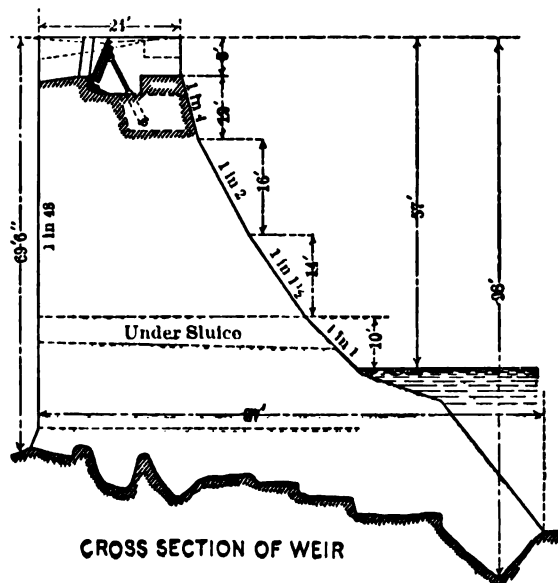


FIG. 34.—FOLSOM DAM.

tures of this kind erected in the Western States which is not curved in plan. It crosses the river on a straight line and is only curved where it joins the side-wall of the diversion canal. The whole length on top, including the curved part at the canal, is 650 feet. An overflow-weir 6×180 feet is formed in the centre of the dam. It can be closed by a single movable shutter consisting of a Pratt truss backed with wood, which is operated by means of hydraulic jacks.

The masonry consists of rough granite ashlar, composed of large blocks weighing

10 tons or more, laid in Portland-cement mortar. The dam proper contains about 48,590 cubic yards of masonry.

**The Hemmet Dam<sup>s</sup>** (Plate LXVII) was built across the south fork of the San Jacinto River, in California, to form a reservoir for irrigation purposes. The enterprise was projected in 1886, but the work on the dam was not begun until January, 1891. According to the original plans the dam was to reach a height of 150 feet above the creek-bed. It was determined, however, to stop the wall, for the present, at an elevation of 122.5 feet, to which height it was brought by the fall of 1895, after various delays caused by freshets. The height above the lowest foundation is 135.5 feet. The dam was built up to an elevation of 110 feet according to the profile designed for a 150-foot dam. At this level, where the dam has a thickness of 30 feet, an offset of 18 feet was made from the front face, and the dam was then carried up 12.5 feet higher, so as to make the top-width 10 feet. Below the 110-foot level the front and back faces are sloped respectively 5 in 10 and 1 in 10. The bottom-width is 100 feet. The lengths of the wall on top and at the bottom of the valley are respectively 280 and 40 feet. The dam is curved in plan to a radius of 225.4 feet. A notch, 1×50 feet, was left in the wall to act as a waste-weir, but during severe freshets the water overflows the whole dam.

The dam contains 31,105 cubic yards of granite rubble masonry. The large stones were placed at least 6 inches apart, the spaces between them being filled with concrete made with Portland-cement mortar in the following proportions, viz.: 1 part cement, 3 parts sand, and 6 parts stone crushed to pass through a 2½-inch ring. The mortar and concrete were mixed in iron boxes revolved by water-power. All the cement used in the dam (about 20,000 barrels) had to be hauled for 23 miles up the mountain to an elevation of 500 to 600 feet, over grades of about 18 per cent. The cost of a barrel of cement delivered on the ground was about \$5.00.

Two 22-inch pipes (respectively at the 45- and 75-foot levels) form the outlet from the reservoir. Their up-stream ends are turned upwards by elbows and flared to 30 inches in diameter. The pipes can be closed in the reservoir by hemispherical covers operated by wire ropes, each passing over a pulley and windlass on top of the dam, but the covers are usually raised and replaced by fish-screens, the outlet-pipes being controlled by stop-cocks set below the dam.

**The Colorado Dam\*** (Plate LXVIII.) was constructed in 1891-92 across the Colorado River, about two miles above Austin, to furnish power for pumping that city's water-supply, for electric lighting, for propelling street cars, and for general manufacturing purposes.

At the site selected for the dam, the river flows in a deep gorge in limestone, with bluffs on either side rising as high as 150 feet. The dam was founded on the rock forming the river-bed, which was only excavated at the faces of the wall, to a depth of about 4 feet. It was constructed entirely of masonry, the faces and the coping being formed of blue granite that was quarried in Bennet County, Texas, at

\* See *Engineering News*, July 11, 1891. See Report on the Austin (Colorado) Dam by J. T. Fanning, Consulting Engineer, June 22, 1892.

a distance of 80 miles from the work, the balance of the dam being built of rubble masonry, composed of hard limestone, obtained at the site of the dam, and of hydraulic mortar composed of 1 part Portland cement to 3 parts of sand. The coping stones were fastened by iron dowels and clamps.

The masonry laid in the dam amounted to about 18,000 cubic yards of granite cut stone and about 70,000 cubic yards of limestone rubble, the price paid for the former class of masonry being \$11—\$15, and for the latter \$3.60 per cubic yard. Fifty cents additional price per cubic yard was paid where Portland cement was used.

Including the bulkheads, at either side, the length of the dam is 1275 feet, of which 1125 feet form the overflow-weir.

The water-shed above the dam contains about 50,000 square miles, from which a maximum quantity of water of about 250,000 cubic feet per second flows over the dam.

The lake formed by the dam is 25 miles long. A canal 90 feet wide and 15 feet deep conveys the water to the turbine-wheels.

The power obtained is estimated at 14,636 H.P. for 60 working hours per week, of which 720 H.P. are required for pumping the city's water-supply.

The cost of the dam was about \$570,000, and the cost of the entire work, including dam, power-house, reservoir and distributing system, was about \$1,400,000.

The whole cost was borne by the city of Austin. The works were designed and constructed under Mr. Joseph Frizzell, Chief Engineer, and Mr. John Bogart and Mr. J. T. Fanning, Consulting Engineers.

The dam failed on April 7, 1900, after a severe rainstorm. Five inches of rain fell.

**Failure of the Colorado Dam at Austin, Texas.\***—A heavy rainfall of 5 inches fell in Austin and vicinity from 1 P.M. on April 6th to 4 A.M. on April 7th, 1900, in a mountainous country and on ground that was already saturated. Tremendous rains fell, also, along the Colorado and its tributaries for a distance of 100 miles above Austin. The river rose rapidly, and by 11.20 A.M. on April 7th it reached a level of 11.07 feet above the top of the dam, 1.27 feet above the highest previous flood-level. The dam gave way at a point about 300 feet from its east end. The current pushed its way through the gap that was made and shoved two sections of the dam, one on each side of the gap, and each about 250 feet long, bodily about 60 feet down-stream, without the slightest overturning, leaving them almost parallel with their original position.

Forty minutes after the break the western section of the dam that had been shoved forwards and part of the eastern section turned over towards the dam and disappeared beneath the torrent. The remaining portion of the eastern section of the dam was swept away during the succeeding night.

The failure of the dam appears to have been due to sliding, made possible by the fact that the down-stream toe of the dam was being undermined by the water flowing over the dam and by a steady stream from the power-house, which flowed in a canal (tail-race) along the toe of the dam to the channel of the river. This location of the tail-race from

---

\* The Austin Dam, by Thomas U. Taylor, Paper No. 40 of Water-supply and Irrigation Papers of the U. S. Geological Survey.

the power-house was very faulty and contrary to the plan of the first chief engineer, Mr. J. P. Frizell, who resigned early in 1892, as the Board of Public Works, under whose direction the dam was built, interfered much in the engineering questions involved.

The foundation on which the dam was built was very poor in places. For the first 150 feet from the eastern bluff a good rock foundation was obtained, but at this point a fault 75 feet wide, extending to an indefinite depth, filled with adobe, or pulverized drock, with an occasional streak of red clay, was encountered. The excavation in this space was carried down 8 or 10 feet in the up-stream trench, which was widened from 4 feet to 10-15 feet. The dam was given an additional protection opposite the fault by dumping clay along its up-stream face.

From the west end of the fault the rock was of poor quality for 350 feet, but for the remaining part of the dam a hard stratum of limestone was obtained as a foundation. At the site selected for the dam the formation consists of alternate hard and soft strata of limestone, the latter being so soft that the material can be excavated with a pick and a shovel. As already stated, the western part of the dam was founded on a hard stratum of limestone. During a freshet in 1892, however, the water flowing over the dam cut through the hard stratum and tore up large pieces of rock, some weighing 7-8 tons, and deposited them 150-200 yards down-stream.

A much better site than the one selected could have been found in the plateau country, 1 to 2 miles up-stream from Austin, where the formation consists of hard limestone in horizontal strata. Such a site would have included certain other advantages and was advocated by Mr. Frizell, who was, however, overruled by the Board of Public Works, which wished to have the dam near Austin.

Mr. Frizell appears to have fully realized the danger to which the dam might be exposed from erosion. His plans contemplated an extension of the massive apron of the dam by a bed of concrete, to be applied as soon as necessary. After he had resigned as chief engineer, Mr. Frizell addressed a letter to the Mayor of Austin on April 8, 1896,—four years before the dam failed,—calling his attention to the dangerous abrasion that might occur 300-400 feet from the east end.

From what has been stated above the causes of the failure of the Austin dam are very evident, viz.: first, a poor foundation, and, second, insufficient protection against the erosive action of the water at the down stream face. If the Board of Public Works in charge of the construction had listened to the advice of its engineers this failure would probably not have had to be recorded.

**The Dam of the Butte City Water Company<sup>S\*</sup>** was constructed in 1893-95 across Basin Creek to form a reservoir for the water-supply of Butte City, Mont.

The dam is located about 5900 feet above the level of the sea in a region where there is practically no rain, the reservoir being filled by melting snow. Its principal dimensions were to be, according to the adopted plans:

---

\* Engineering News, December 17, 1892, August 7, 1893, and September 5, 1895.

Top-width.....	10 feet.
Bottom-width. . . . .	83 "
Maximum height. . . . .	120 "
Length on top. . . . .	350 "
Radius of plan. . . . .	350 "
Length of waste-weir. . . . .	15 "

The reservoir was to have an area of 130 acres and a capacity of 1,000,000,000 U. S. gallons.

The dam has only been built up, thus far, to a level 40 feet below the projected crest. It is at present 88 feet high and stores about 200,000,000 gallons.

The dam was constructed of large stones placed in concrete (made of crushed granite and Yankton Portland-cement mortar), faced with hard blue granite.

A 20-inch waste-pipe and two 20-inch supply-pipes pass through the masonry.

The water is conveyed from the dam to the city by a banded, red-wood stave pipe, 24 inches in diameter, 9 miles long, and, then, by a lap-welded 20-inch steel pipe 3 miles long.

The works were designed by Mr. Chester B. Davis, M. Am. Soc. C. E., and was constructed under the direction of Eugene Carroll, the Chief Engineer of the Water Company.

**The Sodom Dam** (Plate LXIX) was constructed in 1888-1893 to form a new storage reservoir for the water-supply of the city of New York. The work was performed under the direction of the Aqueduct Commissioners (who were given charge of the construction of the New Croton Works by Chapter 490 of the Laws of 1883), Mr. A. Fteley being Chief Engineer.

The Sodom Reservoir and the Bog Brook Reservoir form together what is known as the "Double Reservoir I" on the East Branch of the Croton River. While these two basins have about equal storage capacities, the water-shed of the former is about twenty times as large as that of the latter, the areas of the water-sheds being respectively 73.42 and 3.5 square miles. To compensate for this difference, the two basins are united by a tunnel 10 feet in diameter and 2000 feet long.

The storage capacity of the double reservoir I is about 9,500,000,000 gallons.

The Sodom Reservoir is formed by a masonry dam, built across the East Branch of the Croton River, and by an earthen bank about 9 feet high and 600 feet long, constructed nearly at right angles to the masonry structure on a ridge to the east of it. The earthen dam is continued by a masonry overflow-wall about 8 feet high and 500 feet long, its top being at an elevation of about 415 feet above mean tide in the Hudson River at Sing Sing.

The principal dimensions of the masonry dam are as follows:

Length at coping, . . . . .	500 feet.
Maximum height above foundation, . . . . .	98 "
"    "    "    ground, . . . . .	78 "
Top-width, . . . . .	12 "
Width at foundation, . . . . .	53 "

The total amount of masonry placed in the structure was 35,887 cubic yards.

Near the centre of the dam a gate-house, 37 feet by 42 feet, was built for controlling the flow from the reservoir, which takes place through two 48-inch cast-iron pipes.

The masonry was laid with the utmost care. The foundation, which was throughout solid rock, was swept with wire stable-brooms and washed clean by means of streams from hose-pipes. The irregularities of the bed-rock were generally levelled by layers of concrete made with Portland cement. Where water issued from cracks in the rocks, however, better results were obtained by laying rubble made of small stones, by which the water was confined to small wells about 2 feet in diameter. When the mortar of the rubble masonry had set sufficiently, the wells were bailed out and quickly filled with dry mortar into which large rubble stones were bedded.

The mortar consisted principally of Portland cement and sand, mixed 1 to 2 in the lower and upper parts of the wall and 1 to 3 in the middle part.

An interesting feature of the construction of the Sodom Dam was the use of a steel cable, 2 inches in diameter and weighing 7 lbs. per foot, which was stretched across the valley and served for delivering the building materials on the wall. The cable was stretched across two towers, 667 feet apart, and anchored into the bed-rock.

For a full description of the details of the construction of the Sodom Dam we refer the reader to a paper on this subject written by Mr. Walter McCulloh, M. Am. Soc. C. E. and published in the transactions of the American Society of Civil Engineers for March 1893.

Owing to the great care taken in laying the masonry in the Sodom Dam, this structure has proved to be perfectly water-tight. In this connection we quote the following remarks from the paper just mentioned:

"As to the water-tightness of Sodom Dam, it is perfect. When the reservoir is filled (with 68 feet of water behind the wall) many careful examinations have failed to disclose any leaks whatever, either through the wall or under it, or through the rock around the ends in the side hill. 'Sweating' at the joints in the facing stone appears at several points only, but not in sufficient quantity to produce a trickle. What moisture there is will wholly disappear on a dry, clear day; but if the day be humid, dampness is visible upon the face of the stone as well as at the joints."

The contract for the Sodom Dam and its appurtenances was awarded to Sullivan, Rider & Dougherty on December 30, 1887. Ground was broken on February 22, 1888. Owing to various delays the work was not finished and finally accepted by the Aqueduct Commissioners until October 31, 1892.

The engineers in immediate charge of the work under the directions of the Chief Engineer were Mr. George B. Burbank, Division Engineer, and Mr. Walter McCulloh, Assistant Engineer. On the resignation of the former, June 17, 1891, the latter was appointed Division Engineer and had charge of the work to its completion.

**The Titicus Dam** (Plates LXX. to LXXVI.) was constructed in 1890 to 1895 across the Titicus River, an affluent of the Croton, near the village of Purdy's Station, N. Y., to form a storage reservoir for the water-supply of the city of New York.

The dam consists of a central wall of masonry which is extended on each side





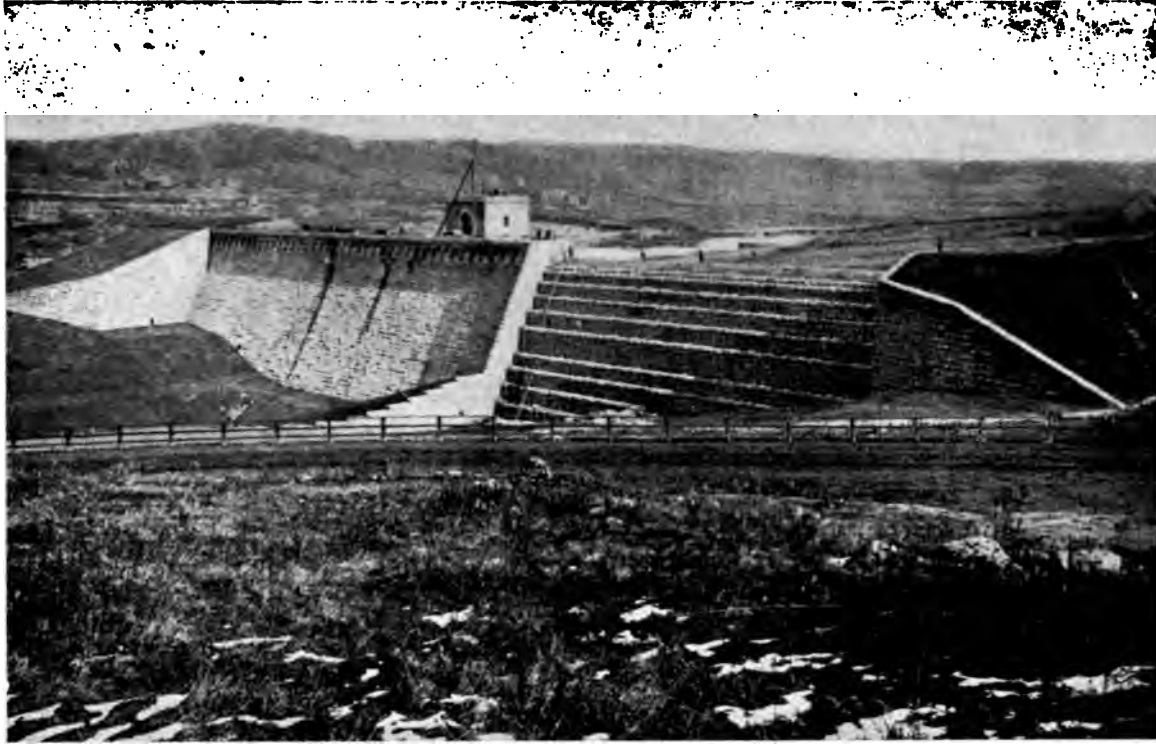
SODOM DAM.



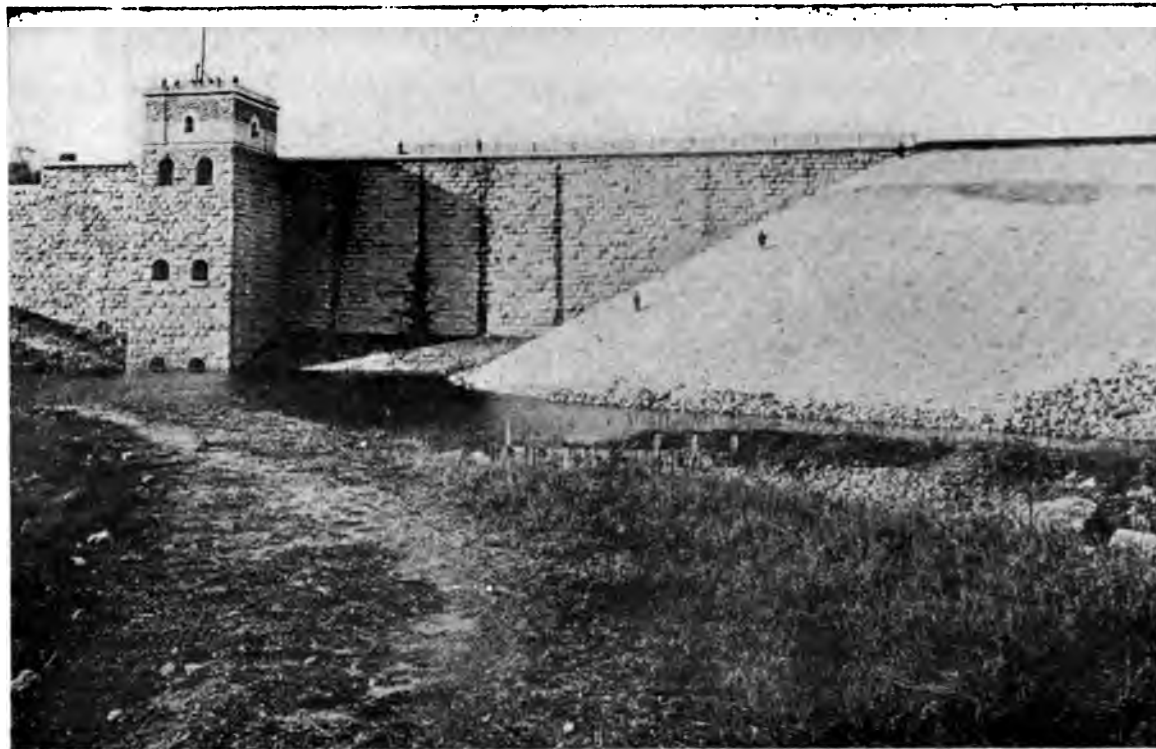
SODOM DAM, IN CONSTRUCTION.



PLATE M.



TITICUS DAM, FRONT FACE.



TITICUS DAM, BACK FACE.

100

1000

by an earthen dam. The central masonry structure, part of which forms the overflow-weir, has a length of 534 feet. The lengths of the north and south earthen dams are respectively 732 and 253 feet, the whole length of the dam being 1519 feet.

The masonry portion of the dam was founded entirely on rock. The earthen dams were provided with masonry core-walls which were founded on hard-pan with the exception of a short distance on both sides of the masonry dam, where a rock foundation was obtained.

The principal dimensions of the masonry dam are:

Width under coping, . . . . .	20.7 feet.
Width about 109 feet below coping, . . . . .	75.2 "
Maximum height above foundation, . . . . .	135.0 "
Maximum height above surface, . . . . .	109.0 "

The waste-weir or overfall, which has a length of 200 feet, is built according to the stepped profile shown on Plate LXXIV.

The masonry consists of rubble, faced up-stream and down-stream with cut stone, laid in regular courses. The bulk of the rubble is composed of large stones, containing 3 to 30 cubic feet, the spaces between them being filled with mortar, into which small stones are bedded.

The cornice of the dam, the top of the overflow, and the superstructure of the gate-house are constructed of granite dimension-stone. All the stone required for the dam was obtained from a quarry situated about  $1\frac{1}{2}$  miles from the work. It was transported on a tramway, partly by gravity and partly by means of a small locomotive.

Both American and Portland cement were used for the mortar, which was usually composed of 1 part cement to 2 parts of sand. Part of the masonry was laid during freezing weather, the mortar being mixed with brine and the sand heated. The stones were steamed before being laid. No masonry was laid, however, when the temperature was below 20° Fahrenheit.

Thirty-six masons with six derricks were usually employed on the wall. They laid on an average 3240 cubic yards of masonry per month and a maximum of 5700 cubic yards.

The earthen dam, constructed on both sides of the masonry structure, has a maximum height of 102 feet above the surface and rises 9 feet above the crest of the overflow-weir. It has a top-width of 30 feet and slopes of about  $2\frac{1}{2}$  to 1. The up-stream face is covered with a paving of stones (18 inches deep, laid on 12 inches of broken stone) which extends 5 feet above the top of the overflow. The top of the dam, the down-stream slope, and the up-stream slope above the paving are sodded.

The core-wall, which is constructed of rubble masonry, is 5 feet wide on top, and 17 feet wide at a depth of 98 feet, both faces being battered about .06 foot per foot. Below this depth both faces are vertical. The core-wall has a maximum height of 124 feet above the foundation.

The flow from the reservoir is regulated by a gate-house, which is constructed

on the up-stream face of the dam, near the overflow-weir. A central wall divides the substructure of the gate-house into two divisions, each of which is divided by a cross-wall into an inlet and an outlet water-chamber. The former has three inlet openings (6 feet wide and 8 to  $9\frac{1}{2}$  feet high): one at the surface of the reservoir, one at mid-depth, and one at the bottom. These openings are protected by screens made of  $\frac{1}{2} \times 2\frac{1}{2}$ -inch iron. They can be closed by means of stop-planks or wooden drop-gates which are placed in grooves provided in the side-walls of the substructure. There are two sets of grooves, 2 feet 5 inches apart. By placing stop-planks in them and filling the intervening space with a puddle of clay and earth a tight coffer-dam can be built which cuts off the gate-house securely from the reservoir. In ordinary cases one set of stop-planks suffices for this purpose, if the joints are properly calked.

The cross-wall between each inlet and outlet chamber has two openings (one at the bottom and one at mid-depth) which are controlled by  $2 \times 5$ -foot sluice-gates, operated from the floor of the gate-house. The top of the cross-wall forms an overflow-weir, the height of which can be regulated by means of stop-planks. Two sets of grooves are provided in the side-walls for these stop-planks, as at the inlet openings.

Two 48-inch outlet-pipes (one for each division of the gate-house) convey the water from the outlet-chambers to the old channel of the Titicus River, which was excavated to rock for a short distance. Each of the lines of outlet-pipes is controlled by a stop-cock placed in a vault about 80 feet below the gate-house. Besides these pipes, a 24-inch drainage-pipe, that was used during the construction of the reservoir, passes through the dam. Its up-stream end is closed by a flap-valve.

The superstructure of the gate-house is 32 feet 6 inches  $\times$  35 feet in plan. It is constructed of granite and has a roof of brick arches sprung from I beams. The floor of the building consists of a cast-iron grating supported by I beams.

Before the work on the dam was commenced, the Titicus River was diverted by building a crib-dam about 1000 feet above the site of the masonry dam. A new channel 1000 feet long (25 feet wide and 8 feet deep) was excavated on the south bank of the river. It was continued by a wooden flume (Plate LXXV.), about 600 feet long, which passed through the masonry dam about 25 feet above the original bed of the river. The flume had two compartments, each 9 feet wide by 7 feet 9 inches high. After the masonry dam had been brought up to the top of the flume, the latter was turned so as to discharge the water it carried into the lowest inlet of the gate-house, whence the water escaped through the 48-inch outlet-pipes. Ordinarily these pipes could discharge all the water flowing in the Titicus River. Provision was made for freshets by keeping part of the overflow-weir 10 to 15 feet below the rest of the masonry. During floods the valley above the dam would fill with water until the depression left in the overflow-weir was reached, where the water would be discharged.

The plans for the work were made by Mr. A. Fteley, Chief Engineer of the Aqueduct Commission of the City of New York. Mr. Charles S. Gowen and later on Mr. Alfred Craven had charge of the work as Division Engineer. Mr. Robert Ridgway was in immediate charge of the work as Assistant Engineer.

The contract for the Titicus Reservoir was let on February 18, 1890, to Washburn,

Shaler & Washburn, who constructed the work in an excellent manner. The reservoir was practically completed by January 1, 1895.

The Old Croton Dam (Plate LXXVI.) was constructed in 1837 to 1842 across the Croton River, to form a storage reservoir for the City of New York. The Old Croton Aqueduct, which has a length of about 41 miles, begins at this reservoir.

At the site selected for this dam the river-channel was 120 feet wide, the ordinary depth of the water being about 4 feet. During freshets this depth was increased to a maximum of about 10 feet. The left bank of the river consists of abrupt rocks, while the right bank is formed of a sandy table-land, about 3 feet higher than the ordinary level of the river, extending back 80 feet to a hill of sand, having a slope of about 45°.

On the location selected for the dam a rock foundation could only be obtained near the south bank. It was, therefore, determined to form the dam of earth, with the exception of the overflow-weir, which was to be constructed of masonry and to be located at the southern extremity of the dam. On the down-stream slope of the earthen bank a protection-wall was to be built.

According to the original plans the overflow-weir was to be 100 feet long, and to be flanked by abutments rising 8 feet above its crest, but, owing to the short distance that the rock extended into the river, the length of the weir was reduced to an average of 90 feet, part of it being obtained by excavating the rock on the south bank. Only the north abutment had to be constructed, the one on the south being formed by the rock. As the length of the weir had been reduced, the north abutment was raised so as to be 15 feet above the crest of the weir on the up-stream, and 12 feet on the down-stream, side. The rock descended so rapidly in the river that an artificial foundation had to be prepared for part of the north abutment.

A waste-culvert, 5 feet by 6 feet, having two sets of suitable gates, operated from a small house on top, was constructed in the abutment, to make it possible to draw down the reservoir whenever it should be required, for repairs or other purposes. A small foot-bridge, placed across the waste-weir, gives access to the gate-house.

Before the earthen dam had been quite completed it was washed away by an unprecedented freshet which occurred during the night of January 7-8, 1841. The gap made by the destruction of the earthen dam was about 200 feet wide. It was decided to fill it up by extending the masonry overflow-weir 180 feet across the channel of the river to a point where it would join the earthen dam near the north bank. As no rock foundation could be obtained for the extension of the masonry structure, an artificial one had to be prepared. The method adopted was as follows (see Plate LXXVI.):

The bottom of the river was cleared of mud and boulders where the masonry was to be built. The space to be occupied by the structure was then enclosed by coffer-dams, formed of heavy cribs which were left in the foundations. The cribs *C* and *D* were first sunk, and covered on top by white-pine planks, 6 inches deep. On top of these cribs two others were placed, and connected together near the top by cross-ties. While the cribs were being carried up, the space between them, *E*, was filled with concrete. In front of *D*, a small crib, *H*, having square timbers only on

its down-stream face, was constructed and securely anchored by timber ties to *D*. The cribs just described formed a coffer-dam on the up-stream side of the foundation. As a protection against the water on the down-stream side the cribs *J*, *K*, and *L* were placed, the crib *J* being filled with concrete and the others with loose stones. On top of these cribs an apron of elm timber was constructed. The square timbers in all the cribs were 12 × 12-inch hemlock. The cross-ties were of oak and were spaced 6 to 10 feet apart. They were dovetailed into the square timbers, and secured by treenails 1 inch in diameter. The crib timbers were fastened together by treenails 2 to 2½ inches in diameter by 30 inches long, placed about 3 feet apart. The planking of the apron was secured to the square timbers on which it rested by 1-inch locust treenails.

After the coffer-dams had been completed the space enclosed by them was excavated to a hard-pan foundation and filled with concrete and masonry as shown on Plate LXXVI. Against the up-stream face of the dam an earthen bank, having a slope of 5 in 1, and extending on the bottom to a width of 275 feet, was constructed. Near the top, the earth bank was paved with stone. Three hundred feet down-stream from the Croton Dam, a secondary dam was constructed of cribs of round timber, filled with stone, the object being to back up the water so as to form a pool to break the force of the water flowing over the weir of the main dam, and, also, to keep the cribs and apron constantly under water.

Since 1842, when the first water-works were completed, the supply of the city of New York has depended on the stability of the Old Croton Dam. As the crest of the masonry part of the dam forms an overflow-weir of only 180 feet in length for a watershed of 360 square miles, much apprehension has been felt, at times, about the safety of the old dam. It has, however, thus far stood, successfully passing during severe freshets a sheet of water over 8 feet deep. Within the next ten years the old dam will be replaced by the New Croton Dam, a masonry wall 290 feet high, which was begun in 1892. This dam is located 3 miles below the old one, which will be submerged about 30 feet when the new reservoir is formed. It was originally intended to build the new dam about a mile further down-stream at the old Quaker Bridge. This project was long before the public. It was finally decided to substitute for it the construction of a dam about a mile further up-stream, which is now being built and is known as the New Croton Dam. As the profile of this dam is based entirely upon that designed for the Quaker Bridge Dam, the exhaustive studies made for the latter have lost none of their interest.

**The Quaker Bridge Dam** (Plate LXXVIII).\*—The plans for the new Croton Aqueduct, which was built in 1884–1891 for the city of New York, included the construction of an immense storage reservoir whose capacity was to be 32,000,000,000 gallons. This artificial lake was to have a surface containing about 3900 acres, and was to be supplied by a watershed of 361 square miles. It was to be formed by closing the Croton Valley about 4½ miles below the present reservoir by a gigantic masonry dam, 1350 feet long, and about 270 feet high at the deepest part of the valley. This structure was named after a bridge near the proposed site, the Quaker Bridge Dam.

---

\* See New Croton Dam, page 162.



According to Chapter 490 of the Laws of 1883, the Department of Public Works of the city of New York is required to prepare all the plans for the new aqueduct and reservoirs, but the construction of these works is entrusted to a commission composed of city officials and private citizens. The first design for the Quaker Bridge Dam\* was prepared, therefore, under the direction of Mr. Isaac Newton, Chief Engineer of the Department of Public Works, who was assisted by E. S. Chesbrough, J. W. Adams and J. B. Francis, as consulting engineers. After receiving this plan, the Aqueduct Commissioners, who were fully impressed with the magnitude and importance of the proposed work, ordered their own Engineer Department, at the head of which they had placed Mr. B. S. Church as Chief Engineer, Mr. Alphonse Fteley as Deputy Chief Engineer, and Mr. J. P. Davis as Consulting Engineer, to make a new and thorough research on the subject of masonry dams. Mr. Fteley was given special charge of this investigation. The mathematical part of the studies was assigned to the writer, who was assisted in this work later on by Mr. Ira A. Shaler.

After protracted investigations the profile shown in Plate LXXVIII. was finally presented to the Aqueduct Commission. Although this design was not then finally accepted, it has been long before the public, and we think, therefore, that a description of it, taken from the published reports of the Chief Engineer, Mr. B. S. Church, and of the Consulting Engineer, Mr. Fteley,† may be of some interest.

The profile was based upon the following data and conditions :

	Elevation, in feet, referred to Croton Datum.‡ Bed-rock.	
Top of dam, . . . . .	210	262
Highest water-level, . . . . .	206	258
River-bed, . . . . .	35	87
Bed-rock, . . . . .	-52	0
Base of dam, . . . . .	-58	-6

The top width of the dam is to be 20 feet.

The water-pressure is supposed to act on the back face of the dam from elevation 206 to -52 = 258 feet; and on the front face from elevation 35 to -52 = 87 feet. Only the horizontal thrust of the water is considered, the vertical component being neglected. The small error resulting from this omission is in the direction of safety.

The wind-pressure is not considered in the calculations.

The weight of the masonry is assumed to be  $156\frac{25}{100}$  pounds per cubic foot (corresponding to a specific gravity of 2.5); this weight being determined by experimental blocks.

The weight of the water is taken as 62.5 pounds per cubic foot.

The weight of the gravel saturated with water, which lie on the slopes of the dam below the river-bed, is assumed to be 145.88 pounds per cubic foot, which equals 94 per cent of an equivalent volume of masonry. This figure is determined by taking the gravel

\* This design is shown on Plate LXXVII.

† Mr. Fteley resigned the position of Deputy Chief Engineer on July 31st, 1886. He acted as Consulting Engineer of the Aqueduct Commission until November 1888, when he succeeded Mr. Church as Chief Engineer.

‡ Croton Datum is the average mean tide at Sing Sing, about 30 miles above New York.

to weigh 125 pounds per cubic foot, and by supposing one third of its bulk to be filled with water.

In all the calculations one cubic foot of masonry is taken as the unit of weight.

The masonry is assumed to be impervious to water.

The profile is to comply with the following conditions:

First. The lines of pressure are to lie within the centre third of the profile, whether the reservoir be full or empty.

Second. The pressures in the masonry are not to exceed the following limits: For a depth of water of 110 feet or less, 8.2 tons of 2000 lbs. per square foot at the front face, and 10.3 tons of 2000 lbs. per square foot at the back face (these limits being equal to 8 and 10 kilos. per square centimetre respectively). From a depth of 110 feet to the base of the dam the pressures are to increase gradually so as to reach a maximum amount of 15 tons of 2000 lbs. per square foot at the base. The pressures in the masonry are to be calculated by formula A or B, page 14.

Third. The dam is to have ample safety against shearing or sliding.

The conditions stated above differ from those given by Rankine and other recent authorities only in the high limit of pressure adopted for the lower part of the dam. This departure from the usual recommendations was rendered necessary by the great height of the dam. Had the limits of pressure of 8.2 tons per square foot at the front face and 10.3 tons at the back face been used for the whole dam, the width of the base would have been about 350 feet, and the faces at the base would have become exceedingly flat. Under these circumstances it cannot be supposed that the maxima pressures at the base would occur at the faces in accordance with formulæ A and B. The thin triangles of masonry between the faces and the base could not transmit great pressures, and would therefore involve a waste of material. Some practical limit must evidently be placed to the flatness of the faces of a dam. This consideration resulted in the profile for the Quaker Bridge Dam being designed with the pressures in the masonry increasing gradually towards the base, where a maximum strain of 30,000 lbs. per square foot would be reached in the *Theoretical Profile*. The necessity of confining the lines of pressure within the centre third of the profile precluded the use of such high pressures in the upper part of the dam.

Although the maxima pressures in the Quaker Bridge Dam will be considerably above the limits usually adopted for similar structures, yet they will exceed but slightly the pressure of about 28,660 lbs. per square foot sustained by the masonry of the Almanza Dam successfully for three centuries. The materials to be employed in the wall will be sufficiently strong to resist much greater stresses than those to which they will be subjected.

The theoretical profile for the Quaker Bridge Dam was calculated by the method\* we have explained in Chapter III., Equations (1) to (7) being used with the following modifications: Equation (1), page 21, is based upon the assumption that the water-surface

---

\* For the preliminary profiles the writer devised a method of trial-calculations, which consists in estimating the probable length of a given joint from that of the joint above, the correctness of the assumed length being tested by taking moments about a vertical axis as explained in the method given for checking a profile, in Chapter III., page 27. This simple but laborious process was subsequently improved by substituting the exact equations given in Chapter III. for the trial-calculations.

is at the top of the dam. As the highest flow-line at the Quaker Bridge Dam was assumed to be 4 feet below the top of the dam, the depth to which both faces could be continued vertical was found by the following formula:

Let  $b$  = the superelevation of the dam above the highest water-level. Using the letters given on page 18. we have

$$x = a = u + v + n. \quad \dots \dots \dots (1),$$

Substituting

$$u = \frac{a}{3}, \quad n = \frac{a}{2}, \quad v = \frac{M}{W} = \frac{a^2}{(d+b)a},$$

we find, by reducing,

$$d^2 - ra^2d - ba^2r = 0.$$

The next courses of the dam were determined by using Equations (2), (3), (4) and (6) to elevation 96, which is at a depth of 110 feet below the surface of the water. It was decided to give one batter to each face of the dam from this elevation to the base, where the limiting pressure should equal 15 tons of 2000 lbs., both for reservoir full and empty. The gravel resting on the dam below the river-bed complicated the conditions. Mr. Ira A. Shaler, Assistant Engineer, found the following equations for determining the width of the base by making the proper substitutions for this special case in the general Equations (I) and (III), pages 16 and 20:

$$\begin{aligned} x^2[p + q - h(1 + \beta\vartheta^2)] + x[lh(\beta\vartheta^2 - 1) - 2w] &= 6M; \\ y[hx(1 + 2\vartheta^2\beta - 3\vartheta^2\beta) + hl(2 - 2\vartheta^2\beta) + 6w] \\ &= hx^2(1 - \vartheta^2\beta + \vartheta^2\beta) - hl^2(1 - \vartheta^2\beta) \\ &+ hxl(1 - 2\vartheta^2\beta + \vartheta^2\beta) - 6wm \\ &+ 4wx - qx^2; \end{aligned}$$

in which

$\beta$  = the ratio of unit weight of gravel to unit weight of masonry;

$\vartheta = \frac{g}{h}$ ,  $g$  being the depth of gravel overlying the base.

The other letters are used as on page 18,

Having calculated the theoretical profile, it was modified in the following manner in order to obtain a practical design:

1st. A few simple batters were substituted for the many changes in the theoretical form.

2d. The thickness of the profile was increased slightly between the top of the dam and elevation 170 (between which limits the water-surface is supposed to fluctuate) in order to increase the strength of this part of the wall against shocks from floating bodies, and also to add to the symmetry of the profile.

Finally, a few steps were substituted for the sharp triangle of masonry between the

front face and the base. This change reduced the width of the base from 230 feet to 216 feet, avoiding thus a considerable amount of expensive excavation.

The practical profile being designed, the pressures in the masonry were calculated and the following results obtained:

Maximum pressure at front face,	. . .	15.4 tons of 2000 lbs. per sq. ft.			
“ “ at back face,	. . .	16.6 “ “ “ “			
Average “ on base,	. . . .	10.5 “ “ “ “			

As regards the plan of the dam, the question whether it ought to be curved or straight was discussed fully in the reports of the Chief Engineer and Consulting Engineer. Both these gentlemen recommended that a straight plan should be adopted on account of the great width of the valley.

In concluding our description of the proposed Quaker Bridge Dam, we wish to state that, while this structure will be about one hundred feet higher than any existing dam, the pressures at its base are within limits that the materials to be employed in the construction fully warrant, and exceed but slightly those sustained safely in the Almanza Dam for more than three centuries. The profile for the Quaker Bridge Dam has been based upon principles which the experience with many high masonry dams, built within recent years abroad, has proved to be safe, and no apprehensions need therefore be felt as regards the strength of the proposed dam to withstand successfully the thrust of the water in the reservoir and the crushing strains in its masonry.

[*Note.*—After the above description of the proposed Quaker Bridge Dam was written, the Aqueduct Commissioners appointed Joseph P. Davis, James J. R. Croes, and William F. Shunk, as a Board of Experts, to consider the plans proposed for this dam. The following extracts from the report of these eminent engineers give the conclusions at which they arrived as regards the profile and plan of the dam:

EXTRACTS FROM REPORT OF THE BOARD OF EXPERTS.

NEW YORK, October 1, 1888.

*To the Honorable the Aqueduct Commissioners:*

By a resolution of the Aqueduct Commissioners, adopted March 7th last, and by subsequent action, the undersigned were appointed a Board of Experts to take into consideration the plans of the Quaker Bridge Dam, as projected by the Engineers of the Commissioners, and modifications which had been or might be suggested by others, either in plan or cross-section, and to fully advise the Commissioners on the subject.

We have found that the work assigned to us required much more extended investigations than were anticipated, but we have at length finished them, and now have the honor to report the conclusions at which we have arrived.

The proposed location of the Quaker Bridge Dam is at a point on the Croton River, at about two miles above its mouth, where the steep sides of the valley approach to form a ravine. This ravine is about 1300 feet wide at an elevation of 230 feet above tide level, 300 feet wide at the level of the river-bed, 35 feet above tide, and has a rock bottom 87 feet below the stream level, or 52 feet below the tide level in the Hudson River.

It is proposed to close this ravine with a masonry dam which will impound the

waters of the stream and raise the water level to a height of 200 feet above mean high tide. The greatest height of the dam from foundation level to the top of road parapet will be, therefore, from 265 to 270 feet, depending upon the character of the surface of the rock at the deepest point.

It will be about 100 feet higher than any dam yet built.

It is to impound upwards of 5,000,000,000 cubic feet of water in an artificial lake 16 miles long and 165 feet deep at its lower end.

The water-shed tributary to it has an area of 361 square miles and contains a number of storage basins with an aggregate capacity of 1,200,000,000 cubic feet, averaging about 7 miles distant from the Quaker Bridge Lake and 300 feet above its level.

A new dam is now building which will increase this capacity to upwards of 1,800,000,000 cubic feet.

The greatest recorded flood of the river, measured at Croton Dam, is 1,070,000,000 cubic feet in 24 hours.

Most dams of great height are built of stone, laid in hydraulic mortar. This is the class of work recommended by recent writers upon the subject. The three profiles presented to us for consideration are proportioned for masonry of this kind, and we understood that its use for Quaker Bridge Dam had been determined upon by the Aque-duct Commissioners. We have therefore limited our studies to dams so built.

Our first discussions related chiefly to the forces, whether usual or exceptional, that might be brought to bear upon the structure. These were classed under four general heads:

(1) The quiescent and ever-acting forces, such as the weight of the masonry and the pressure produced by the impounded water.

(2) Forces produced by the expansion of ice in place, or by floating masses.

(3) Forces produced by waves of translation, the possible cause of such waves being the giving way of a dam above or an extensive land-slide.

(4) Earthquake shocks.

*Quiescent Forces.*—It was determined that the specific gravity of the masonry should be taken at 2.34, making the weight of a cubic foot equal to 2.34 times 62.5 pounds, or 146.25 pounds.

Krantz assumes a specific gravity of 2.3, or a weight of 143.75 pounds per cubic foot for masonry built of hard stone (granite or limestone).

The experiments of M. Bouvier upon granite rubble led him to adopt a weight of 147.3 pounds per cubic foot.

While building Boyd's Corner Dam on the Croton River, a careful account was kept of all the materials entering into its construction, from which account the specific gravities of the various classes of masonry were computed. These varied from 2.13 to 2.71, and the specific gravity of the whole mass was found to be 2.34, and we have thought it best to adopt the same specific gravity for the Quaker Bridge Dam.

The aggregate length of the spillways will be about 1300 feet. A depth of about 2.25 feet on the crest would pass the largest recorded flood in the valley, and it will be only on rare occasions that the water can reach the elevation of 202 feet above the tide.

This elevation for the water surface, as producing what may be termed the maxi-

imum quiescent stresses, has been adopted in computing the pressures which the masonry throughout the body of the dam must resist.

The wasteway, or channel for carrying off the surplus waters from the surface of the reservoir, will be constructed in rock cuts and over subsidiary dams so situated that the overflowing water will not touch the main dam.

*Ice.*—In our search for information upon the expansive force of ice in place, caused by increase of temperature, we found little of value recorded: but we obtained valuable, though somewhat conflicting, information by correspondence and personal interviews, which information, supplemented by experimental data, concerning its strength, elasticity, and rate of expansion under a rising thermometer, has led us to the opinion that the dam should be proportioned to resist a thrust at the highest ice line of about 43,000 pounds per lineal foot.

More positive information was available regarding the force exerted by ice-floes. Under certain unfavorable conditions, where ice-jams form in a quick-running current, it appears to be almost irresistible by direct opposition. But as, in the case of the Quaker Bridge Dam, the water current, when there is one, will tend to divert the floes away from it, and direct impact can be produced only by sheets of ice driven by the wind, we have concluded that, if the dam be proportioned to resist the pressure of 43,000 pounds per lineal foot, above mentioned, it will be of ample strength to withstand the attack of floating masses.

*Waves of Translation.*—To secure the dam from injury by waves of translation, its upper portion, where the effect of such waves would be greatest, has been so designed as to give a coefficient of at least 2 against overturning, when the water level may be at an elevation of 214 feet above tide, or at the top of the parapet.

*Earthquakes.*—Earthquake shocks may vary from a slight tremor to an immeasurable force. The dam, if proportioned to resist the forces before considered, will have ample stability to withstand all but shocks of the severest nature. Probably of all the considerable structures in the region affected by such an earthquake it would be the last to succumb.

*The Profile or Cross-section of the Dam.*—To resist these forces, or at least those of them which may be considered measurable, we have agreed:

- (a) That the coefficient against overturning should, at all points, be not less than 2;
- (b) That the ratio of the weight of the masonry above any horizontal plane or joint, to the maximum force tending to cause sliding or shearing along the plane, should not be less than 3 to 2;
- (c) That the maximum quiescent stress on the down-stream end of the joints at the elevation of the river-bed, 35 feet above tide, should not exceed 10 tons per square foot (139 pounds per square inch);
- (d) That below that elevation, where the strength of the masonry to resist crushing is aided by the lateral pressure of the earth, the maximum quiescent stress should not exceed 14 tons per square foot (194.5 pounds per square inch); and
- (e) That the pressures upon the joints of the up-stream face may be somewhat greater, since they will be permanently reduced as soon as the reservoir begins to fill.

We agree in judging it prudent that in so important a structure as the Quaker Bridge

Dam these conditions should be fulfilled, and we believe that, if fulfilled, the cross-section will be amply strong for the functions it will be called upon to perform.

The profile designed by the Engineers of the Aqueduct Commissioners, and submitted to us by the Commissioners, does not meet the requirements which we think should be met for complete safety. We were therefore, under our instructions as we understood them, called upon to prepare a profile which we could recommend for adoption. We have prepared such a profile, and herewith present it under the title Profile N. (See Plate LXXIX )

Comparing this profile with that of the Aqueduct Engineers, which we have designated Profile Y\* (see Plate LXXIX.), the chief point of difference is in the greater thickness of N in the upper portion of the dam. This increase of thickness appears necessary to resist the shock of ice and excessive freshets. The amount of masonry above the plane 100 feet below the level of the flow line of the reservoir will be about 40,000 cubic yards greater by Profile N than by Profile Y. . . .

We have given the plans laid before us, and the arguments presented to us relative thereto, attentive consideration, covering a field of study so extensive that it has seemed advisable to present herein only the conclusions upon which we are agreed, and not to spread before the Commissioners the method by which they have been reached, or a discussion of the several arguments in detail.

As to curved and straight plans generally, without reference to the Quaker Bridge location, all authorities agree that the same principles should be followed in the designing of the profile, whatever the plan, unless the curve has a very short radius, not exceeding, say, 300 feet.

In studying the transmission of pressures through the masonry of a dam built on a curved plan and subjected to water pressure on one side, we have made calculations of their magnitude, which, while only roughly approximate and showing limits which probably are not exceeded, rather than actual values, yet have appeared to us of sufficient weight to materially aid in reaching just conclusions.

Our conclusions may be thus stated :

(1) That, in designing a dam to close a deep, narrow gorge, it is safe to give a curved form in plan and to rely upon arch action for its stability ; if the radius is short, the cross section of the dam may be reduced below what is termed the gravity section, meaning thereby a cross-section or profile of such proportions that it is able, by the force of gravity alone, to resist the forces tending to overturn it or to slide it on its base at any point.

(2) That a gravity dam, built, in plan, on a curve of long radius, derives no appreciable aid from arch action so long as the masonry remains intact ; but that, in case of a yielding of the masonry, the curved form might prove of advantage.

The division between what may be called a long radius and what may be called a short radius is of course indefinite, and depends somewhat upon the height of the dam. In a general way, we would speak of a radius under 300 feet as a short one, and one of over 600 feet as a long one, for a dam of the height herein contemplated.

(3) That, in a structure of the magnitude and importance of the Quaker Bridge Dam, the question of producing a pleasing architectural effect is second only to that of structural stability, and that such an effect can be better obtained by a plan curved regularly on a long radius than by a plan composed of straight lines with sharp angular deflections.

---

\* This profile is shown by the dotted lines in Plate LXXIX.

(4) That the curved form better accommodates itself to changes of volume due to changes of temperature.

While danger of the rupture of the masonry of the dam by extraordinary forces, if built on the profile herein recommended, is, in our opinion, very remote, yet it exists; and because it exists, and because the curved form is more pleasing to the eye, better satisfies the mind as to the stability of the structure, and more readily accommodates itself to changes of temperature, we think that it should be preferred in any case where it would cause no great addition to the cost.

In comparing different locations of the dam, in order to discover the one which combined most effectively the advantages of economical construction and pleasing effect, we were confronted with the fact that our calculations indicate that, in a dam built upon a curved plan of large radius, the bottom down-stream toe pressures are increased beyond those in a straight dam of the same section, in consequence of the length of the toe being less than the length of the face to which the pressure of the water is applied.

This increase of pressure is not exactly proportional to the decrease of length of toe, but is of such magnitude that it should not be neglected in designing the section of the dam; and it involves the necessity of increasing the mass of masonry in a certain proportion to the radius of the curvature. . . .

*Conclusions.*—In view of the premises and pursuant to our instructions, and believing that the dam will be more pleasing in appearance and better able to resist extraordinary forces if built on a curved plan, and bearing in mind that an excessive thrust in the direction of the curve cannot be produced until the force of gravity has been overcome, and that the profile N is so proportioned that more than twice the greatest pressure exerted by any conceivable ordinary force is necessary to overcome the resistance of gravity, we recommend the adoption of the Profile or Cross-section N, and of a curved plan on a radius of about 1200 feet as hereinbefore described, and we advise that the exact line be determined after further borings shall have established the most desirable location on the conditions prescribed.

It should be added, in conclusion, that the form and dimensions herein recommended for adoption are prescribed on the assumption that the structure shall be well founded, and that its material and workmanship shall be of the first class in their several kinds.

Respectfully submitted,

JOS. P. DAVIS,  
J. J. R. CROES,  
WM. F. SHUNK.]

**The New Croton Dam** (Plates LXXX to LXXXIV).—In the preceding pages we have given an account of the plans prepared for the proposed "Quaker Bridge Dam." Owing to the strong opposition made to this project, the Aqueduct Commissioners decided to build a dam about  $1\frac{1}{4}$  miles farther up-stream on property belonging to A. P. Cornell and others. From this site the dam was at first called the "Cornell Dam," but this name was soon changed to the "New Croton Dam," the reservoir wall built,  $3\frac{1}{4}$  miles farther up-stream, in 1839-1843, to form Croton Lake, being designated as the "Old Croton Dam."

The profile adopted for the New Croton Dam was based entirely on the profile prepared by the engineers of the Aqueduct Commissioners for the Quaker Bridge Dam (Plate LXXVIII), the only difference being that the sharp angles of the latter were



rounded off by the introduction of more changes of batter in the faces and also by increasing the width of the profile of the former dam, somewhat near the top. Both faces of the New Croton Dam were designed to have polygonal outlines, but in actually building the dam curves were substituted for polygonal outlines for the down-stream face.

The construction of the New Croton Dam was begun on September 20, 1892, and was practically completed by January 1, 1907, with the exception of the flash-board equipment for the overflow-weir. The cost of the dam under the original contract, including the construction of about 20 miles of new highways and the reinforcing of about 3 miles of the Old Croton Aqueduct, which is submerged in the reservoir, amounted to \$7,631,185.69.

According to the contract plans the dam was to consist of three parts, viz. (Plates LXXX and LXXXI):

1. A central masonry dam, about 600 feet long, extending across the valley and well into the south slope.

2. A masonry waste-weir, about 1000 feet long, to be built along the rocky side hill forming the north slope of the valley. The waste-weir was to be located nearly at right angles to the main dam and to have its ends connected to said dam and to the hillside by curves. A waste-channel, 50 feet wide at its upper end and 125 feet at its lower end, was to be excavated in rock between the waste-weir and the hillside.

3. An earth dam with masonry core-wall, about 600 feet long, forming a continuation of the masonry dam to the south side of the valley, which was to be built according to the cross-section given on Plate XCIV, Fig. 1.

The masonry dam, waste-weir, and core-wall were all to be founded on rock and to form a continuous wall of masonry across the valley. At the junction of the earth and masonry dams a large masonry wing-wall was to be built. The top of the dam was to be finished as a roadway, which was to be carried across the waste-channel on an arched bridge of 200 feet span. The manner in which the earthen dam was to be built is described on page 242.

On September 16, 1896, the Aqueduct Commissioners decided to extend the masonry dam 110 feet to the south and to reduce the length of the earth dam by the same distance. This change reduced the maximum height of the earth dam from 120 to 50 feet. The discovery of some cracks in the core-wall of the earth dam, which was to have a maximum height of 200 feet, gave rise to some doubts about the safety of this part of the dam. On June 21, 1901, the Aqueduct Commissioners appointed a board of engineers (J. J. R. Croes, Edwin F. Smith, and Elnathan Sweet, members of the American Society of Civil Engineers) to examine the plans for the construction of the dam and the work of construction as far as the same had proceeded, and to report to the Aqueduct Commissioners what changes, if any, should be made in the plans for the construction of the dam. On November 18, 1901, the board of engineers handed in its report, in which it recommended that practically the whole earth dam should be replaced by a masonry dam similar to the one already built, in order to make the dam absolutely secure against disaster. This recommendation was adopted by the Aqueduct Commissioners on April 16, 1902, and the earth dam, which had been about half constructed, was replaced by a masonry structure, with the exception of a short piece 128 feet long from a gate-house built at the point where

the Old Croton Aqueduct crosses the dam, to the southerly end of the dam. The maximum height of this earth bank is only 26 feet.

According to the contract plans the different parts of the dam were to be finished at the following elevations, which refer to Croton Datum, i.e., mean tide at the mouth of the Croton River: Top of waste-weir, elevation 196; top of masonry dam, elevation 210, and top of earth dam, elevation 220. On October 16, 1900, the Aqueduct Commissioners decided to finish the whole dam at elevation 216, and the waste-weir at elevation 200, with the exception of a depressed part 250 feet long, at the junction with the masonry dam, which was to have its crest at elevation 196.

**Protective Works.**—Owing to the great depth to which the foundation-trench for the masonry dam had to be excavated, expensive works were required for turning the river from its former course. A new channel for the river, 125 feet wide and about 1100 feet long, was excavated in the rock on the north side of the valley. To avoid expense it was kept 5 feet higher than the old bed. The river was confined in its new channel on the north by the slope of the hill, and on the south by a masonry wall continued at both ends by earthen dams which extended across the old channel, the upper one serving to turn the river into its new course.

The wall was built for about 300 feet on each side of the centre-line of the dam; it was 3 feet wide at the top and 13 feet at the base, its height being 23 to 25 feet above the grade of the new channel. The face towards the water-channel was almost vertical. On the other side of the wall (except where it crossed the site of the dam) an earth embankment was carried up for about half its height. Some portions of the wall which form permanent work were made stronger than the dimensions given.

The masonry wall was continued at each end by an earthen dam, 10 feet wide on top and about 30 feet high. Towards the channel the banks were sloped  $1\frac{1}{2}$  to 1, and on the opposite side 2 to 1. Water-tightness was insured in these earthen dams by providing them with a core-wall formed of two courses of 3-inch tongued-and-grooved sheet-piles, which extended 3 feet below the top of the banks to about 20 feet below the original surface. The two courses of sheet-piles were spiked together and were stiffened above the river-bed by frequent courses of horizontal range timbers, which were fastened to the sheeting as it was put in place. The toe of the slopes on the channel side was formed of heavy cribwork 10 to 12 feet high. In both dams two cribs, each 10 feet wide, were placed 6 feet apart, the space between them being filled with compact earth. The cribs were joined together by frequent cross-ties extending through the 6-foot spaces. The outer faces of the cribs and those on each side of the filling just mentioned were covered with 3-inch tongued-and-grooved sheeting, sunk  $3\frac{1}{2}$  to 10 feet into the ground below the bottom of the crib. The cribs were to protect the toe of the embankments against the scouring action of the water, which had a depth of 15 to 19 feet during great freshets. The total length of the masonry and earth dams which bound the new channel of the river on the sound was about 1600 feet.

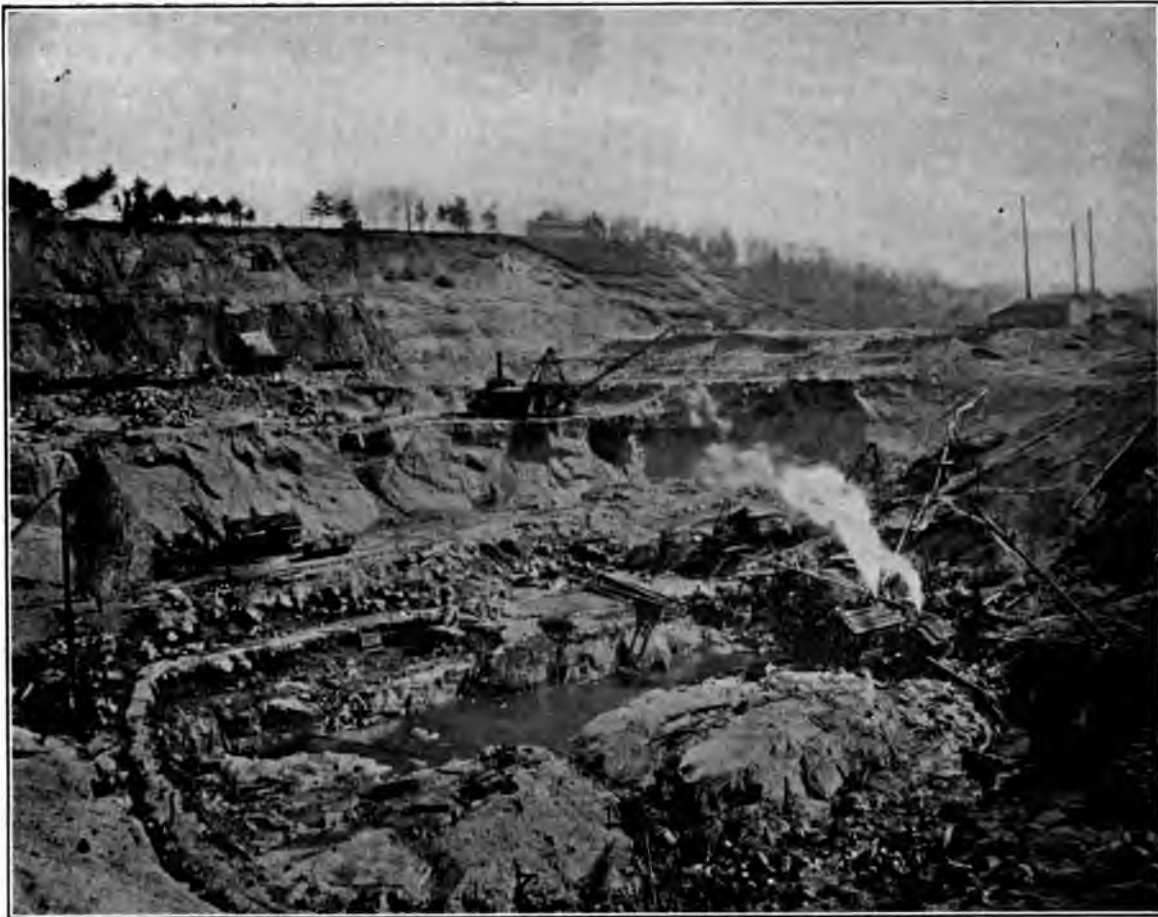
**Excavation for Foundation.**—Owing to the great width of the base of the dam (maximum, 206 feet), the excavation for the foundation had to be made in open trench. In the centre of the valley, sand, gravel, and boulders had to be excavated to a depth of about 70 to 75 feet before the bed-rock was uncovered. Towards the south side of the valley the rock was found to be covered by a layer of hardpan, about 120 feet deep, upon which there was a layer of sand and gravel.

PLATE N.



NEW CROTON DAM.





NEW CROTON DAM. EXCAVATING FOR FOUNDATION.



NEW CROTON DAM. LAYING MASONRY IN FOUNDATION TRENCH.



The excavation below the river-bed was made at first with a large dredge having a  $2\frac{1}{2}$ -cubic-yard dipper on an 80-foot boom. This dredge, which excavated about 800 cubic yards in 10 hours, had to be kept floating in the foundation-trench and was replaced by a steam-shovel of the same capacity when the bed-rock was reached. At one time three steam-shovels were used in making the excavation for the foundation.

Three Lidgerwood cableways, each about 1200 to 1600 feet long, were stretched across the foundation-trench 50 feet apart. They were used in making part of the excavation and, later, in delivering some of the materials required for the masonry. The material excavated was shoveled into skips, holding about 3 cubic yards, which were hoisted and transported by means of the three cableways. As the excavation assumed larger proportions, the cableways were supplemented by railway inclines, placed at different points on the side slopes and operated by means of stationary hoisting engines and cables. From the inclines the materials excavated were hauled by locomotives on a 36-inch-gage track to the spoil-banks.

The bed-rock was found to be gneiss on the north side of the valley and limestone in the centre and on the south side. The two kinds of rock join each other on a line about parallel with and directly under the old river-bed. At the junction of the gneiss and limestone a layer of black schist occurs, about 4 feet wide in places, which extends for a short distance below the surface of the rock. Below the schist the gneiss and limestone are joined like one rock. The gneiss rises rapidly with the north hillside, cropping out in places. The limestone extends level across the valley for a distance of about 400 feet and then rises gradually with the slope of the hillside, being about 25 feet below the surface at the south end of the dam.

The rock upon which the dam had to be founded varied much in character. The gneiss was much fissured and full of seams. The limestone was found, in some places, to be sufficiently hard and water-tight to answer for the foundation, while in other places it was so soft that it could be excavated with a pick and shovel. There were many seams in the limestone and, in one case, a cave, whose dimensions were about  $12 \times 14 \times 20$  feet, was discovered under a heavy stratum of solid rock. All the seams in the limestone contained more or less water, which was, in some cases, under heavy pressure. In one instance the water was under a head of 90 feet, requiring a 10-inch pipe to carry it off.

A great many test-holes were drilled to explore the seams and the rock was excavated to a sufficient depth to insure a good foundation. The maximum depth to which the rock had to be excavated was about 54 feet; the average depth was about 20 feet. The greatest depth of the foundation was 123 feet below the river-bed.

In excavating the foundations for the core-wall, which according to the original plans was to extend about 600 feet from the masonry dam to the side hill, 8 to 24 feet of sand was removed by steam shovels before the hardpan that overlaid the rock was reached. The excavation through the hardpan and 4 to 7 feet into the rock was made in "vertical trench," which was made 6 feet wider than the foundation of the core-wall to allow sufficient space for laying the masonry and for backfilling. The sides of the trench stood vertical when excavated and were sheeted and braced afterwards, as required.

The total amount of material excavated for the foundations of the dam was about 1,821,400 cubic yards of earth and 400,250 cubic yards of rock.

**Masonry.**—After solid rock had been reached and all loose and shaky pieces had been removed, the bottom was thoroughly washed by streams of water under heavy pressure and cleaned with brooms. The rock was then “painted” with a grout of neat cement, applied with brushes, which filled up all small cracks or seams. All erosions and open seams were filled with grout, usually made of Portland cement and fine, sharp sand, mixed, either 1 to 1 or 1 to 2, according to whether the grout had to be pumped or poured. Large seams were filled by placing small stones in the grout. Springs that were encountered in the foundation were either drained off to a sump-hole or were confined in vertical pipes which were finally filled with grout or, in a few cases, with clay that was forced by a drop-hammer into the pipes.

The laying of the foundation masonry was begun on May 26, 1896. With the exception of the extension of the main dam (ordered on April 16, 1902, to replace the earth dam), which was built of cyclopean masonry, the dam and the waste-weir were constructed of rubble masonry, faced above the backfilling with ashlar masonry classified as “facing stone masonry.” In the bottom foundation courses Portland-cement mortar, mixed 1:2, was used. Above the foundation the masonry was laid in American cement mortar, mixed 1 to 2, except in winter, when Portland-cement mortar, mixed 1:3, was used.

The ashlar “facing stone masonry” begins at the waste-weir at the rock surface and for the main dam above the refilling, which was brought up to elevation 70 (i.e., about 27 feet above the old river-bed). This masonry has a depth of at least 28 inches, and is laid in courses ranging in rise from 30 to 20 inches. The joints do not exceed  $\frac{1}{2}$  inch for 4 inches from the face and not over 2 inches wide for the remaining depth. The stretchers are 3 to 7 feet long, and in each course every third stone is a header, at least 4 feet deep. All joints in the up-stream face of the dam and waste-weir were raked out to a depth of 2 inches and pointed with Portland-cement mortar, mixed 1 to 1.

The stone used for the greater part of the dam is a dark-colored granite, named “gabro” rock by geologists. It weighs about 185 pounds per cubic foot, and is very hard and tough.

The work of laying the masonry was continued in winter except in extremely cold weather, when the thermometer remained steadily below the freezing-point. In laying masonry in cold weather salt was added to the cement, the sand was heated in large boxes, provided with steam-coils, and warm water was used in mixing the mortar. On cold nights the fresh work was covered with canvas and in the morning the surfaces and joints of the work were thoroughly cleaned with steam and hot brine.

The maximum force employed on the work, including the quarry, was 851 men (475 on the dam and 376 in the quarry). The best month’s work in the foundation was in June, 1898, when 17,186 cubic yards of masonry was laid.

The description given above applies to the masonry laid in the dam and waste-weir according to the original plans. The extension of the dam, which was ordered to be made to replace the earthen dam, was built of cyclopean masonry, faced above the backfilling with “facing stone masonry” like the rest of the dam.

The profile of the extension of the main dam was made slightly thicker than the contract drawing required, viz., 2.1 feet thicker at elevation 150, the increase diminishing to 0 at elevations 100 and 180, respectively. This was done because the then Chief Engineer, J. Waldo Smith, M. Am. Soc. C. E., considered the profile of the dam to be somewhat deficient in strength in the upper part.



PLATE P.



NEW CROTON DAM. TEMPORARY CHANNEL.



NEW CROTON DAM. LAYING MASONRY ACROSS TEMPORARY CHANNEL.





NEW CROTON DAM. RELIEF OPENINGS IN DAM.



NEW CROTON DAM. UP-STREAM FACE.



The cyclopean masonry consists of large quarry stones, bedded in concrete mixed rather wet in the proportion of 1:2:4, the spaces between the large stones being, also, filled with concrete. About half the bulk of this masonry is concrete. The cyclopean masonry was laid much more rapidly than the rubble masonry that was used for the main part of the dam and for the waste-weir.

One Ransome concrete-mixer and three 4-foot cubical mixers were used on the extension of the dam. Part of the time the work was continued day and night. The maximum amount of cyclopean masonry laid per month was about 16,000 cubic yards, in August, 1904.

In order to avoid the delay caused by shifting derricks, two platforms were erected within the limits of the masonry on the axis of the dam (Plate R\*). The platforms were 55 feet apart. Each platform was supported by six steel columns, about 50 feet high, which were securely anchored to the masonry and braced. The tops of the columns were joined by I-beams, which were covered with 3-inch planks so as to form a platform 25×50 feet, the longer dimension being parallel with the axis of the dam. Four derricks were placed on each platform and kept in use until the masonry reached the level of the platform, viz., elevation 130 (i.e., 86 feet below the top of the dam). As the masonry was carried up the braces and finally the woodwork of the platforms were removed, but the columns were left in the masonry. After the masonry had reached the top of the platforms, a trestlework was built against the down-stream face to support a platform for the derricks and the building materials. Additional trestle-bents were added as the work was carried up (Plate S).

**The Waste-weir.**—The steps on the down-stream side of the waste-weir were built of "block stone masonry," having a uniform rise of 2 feet and sufficient depth to bond under the next step above.

The upper two steps of the waste-weir were coped with large blocks of granite dimension stone, having the exposed surfaces rough pointed. Each of these coping stones was securely anchored to the masonry by means of two 1½-inch twisted Ransome bars, 3½ feet long, which were placed in 2-inch holes, drilled in the coping and masonry and leaded.

**Buttresses, etc.**—The down-stream face of the dam is relieved by four buttresses (see Frontispiece and Plate N). The two central buttresses project about 15 feet, while the two buttresses near the ends of the dam project only 4 feet. On the up-stream side two pilasters are built by corbeling out, opposite the two central buttresses of the down-stream face. They project 1½ feet.

A stairway leading to the floor and roof of the vault-chamber of the blow-off pipes is constructed on the down-stream side of the dam, near its north end. From the level of the roof of the vault-chamber, the stairway is continued inside of the adjoining buttress to the top of the dam.

A similar stairway leading to a platform at elevation 158 is constructed at the next buttress to the south, at the place where originally the earth dam joined the masonry dam, in order to cover the lower part of the dam at this point, which had not been provided with a cut stone facing, as it was to be covered by the slope of the earthen dam.

---

\*The photographs of the New Croton Dam which are reproduced in this book were taken by Pierre Pullis, 32 Park Place, New York.

The ornamental masonry used for the cornice, the parapets at the buttresses, arches for stairway, etc., are built of granite dimension stone.

**Two Gate-houses** were constructed, in connection with the dam, for controlling the flow from the reservoir. The first, known as Gate-house No. 1 (Fig. 36), is built on the down-stream face of the dam near its south end. It regulates the flow into the Old Croton Aqueduct, which crosses the dam at this place. The substructure of the gate-house, which is 55½ feet high, contains four water-chambers. The Old Croton Aqueduct, the flow into which is controlled at the New Croton Gate-house, constructed about three miles above the New Croton Dam, is connected by a brick conduit, 360 feet long, with the southeast chamber. The water flows from this chamber through two sluiceways, each controlled at each end by a 2½×6-foot sluice-gate, into the southwest chamber, which is connected by a masonry conduit, 510 feet long, with the Old Croton Aqueduct below the dam. Water can be drawn at the dam into the northeast chamber of Gate-house No. 1 through a bottom, a middle, or a surface inlet, as may be desired. These inlets consist of masonry conduits

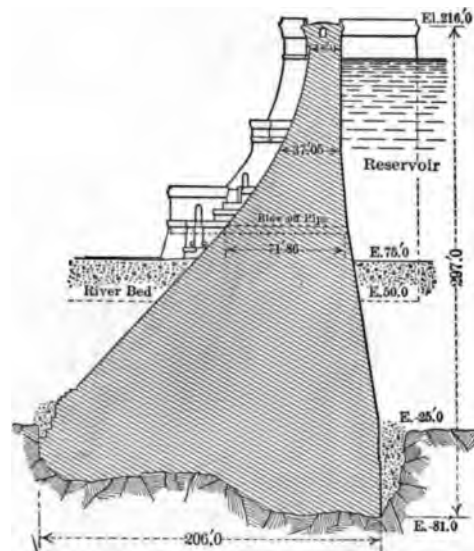


FIG. 35.—MAXIMUM SECTION.

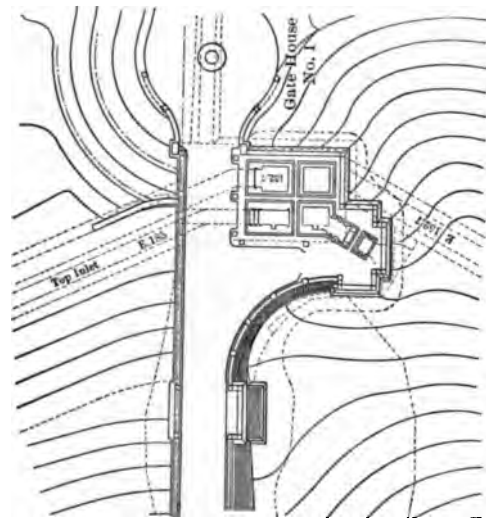


FIG. 36.—GATE-HOUSE NO. 1.

respectively 510 feet, 410 feet, and 22 feet long, having an oval cross-section, 6 feet wide by 10 feet high, on the inside, with an area equal to that of a circle 7½ feet in diameter. The inlets can be closed at the gate-house by timber drop-gates, for which iron grooves are provided in the inlet-openings at the gate-house. The northeast chamber is connected by two sluiceways, each controlled at each end by a 2½×6-foot sluice-gate, with the southeast chamber. It is also connected by an oval passage, 10 feet high by 6 feet wide, with the northwest chamber, from which the water can pass through two sluiceways, each controlled at each end by a 2½×6-foot sluice-gate, into the southwest chamber. The oval passage between the northeast and the northwest chambers can be closed by timber drop-gates. An outlet, controlled by two 2×8-foot sluice-gates is constructed at the northwest corner of the gate-house, which can be connected in the future with a screen-chamber and, then, either with the Old Croton Aqueduct or some new conduit for New York. Iron

pipes, 12 inches in diameter, are placed beneath the floor of the substructure for draining the different water-chambers whenever it may be necessary for repairs or inspection. The different sluice-gates of the gate-house are operated in a vault, constructed beneath the level of the roadway on top of the dam.

Gate-house No. 2 (Fig. 37) was constructed on the up-stream face of the dam at the junction of the masonry dam with the overflow-weir to control the flow through three 48-inch blow-off pipes, which are laid in the masonry of the dam at about elevation 92. The flow into each of these pipes is regulated in the following manner. An inlet-opening 4 feet wide and 52½ feet high is constructed in the up-stream face of the gate-house. Its width is reduced in 2¼ feet to 3 feet. The inlet connects with a chamber 3 feet wide by 6½ feet long extending to the floor of the gate-house (elevation 207). Two sets of 6×6-inch grooves are cut in the sides of this chamber, the up-stream set being used for iron screens, while the down-stream set serves to guide a wooden drop-gate which controls the flow of water from the chamber just described into a sluiceway, 3 feet wide, 6 feet high, and 8 feet long, which leads to a second chamber extending to the floor of the gate-house. For 4 feet this chamber has a width of 7 feet, and for 2 feet, at its down-stream

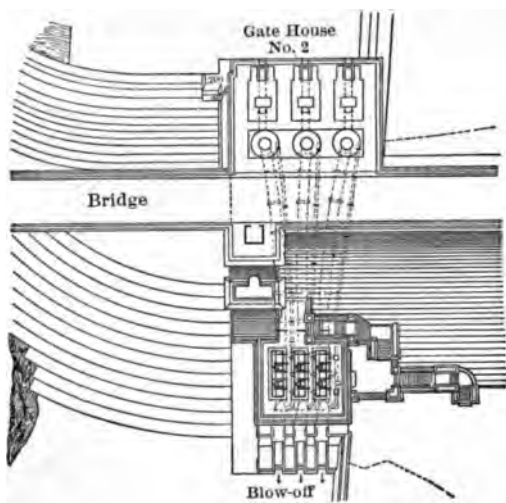


FIG. 37.—GATE-HOUSE No. 2.

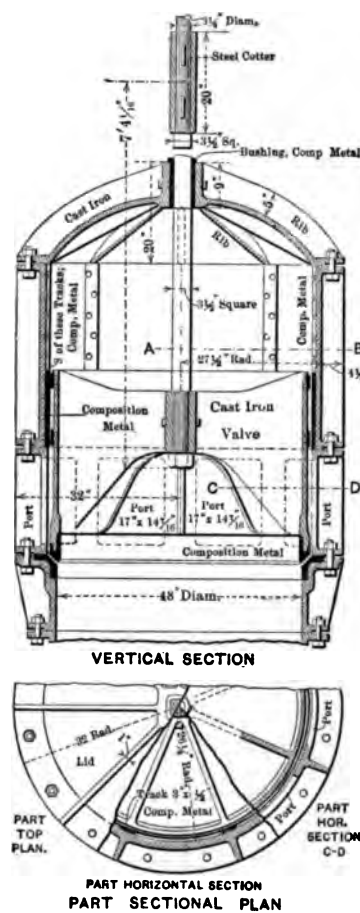


FIG. 38.—BALANCED VALVE.

end, the width is reduced to 3 feet. Grooves are provided in the sides of this chamber, at its down-stream end, for a sluice-gate 3 feet wide by 6 feet high, which is operated from the floor of the gate-house, and controls the flow into a second sluiceway, 3 feet wide, 6 feet high, and 8 feet long.

The sluiceway last described leads to a circular well 12 feet in diameter, constructed in the masonry of the gate-house with its bottom at elevation 99.25. The masonry lining of the well is corbeled, beginning at the elevation 106, so as to terminate the well at the floor of the gate-house with a rectangular opening 7½×12 feet in section. At the

bottom of the well a 48-inch elbow is embedded in the masonry and is connected with one of the blow-off pipes. The inlet into the elbow is controlled by a cylindrical, balanced valve having a conical seat (Fig. 38). This valve is placed in a tight cast-iron casing, which has eight ports through which water can flow into the blow-off pipe when the valve is raised, which is done by means of a stem extending through the casing to the floor of the gate-house, where the hoisting machinery is placed. Each blow-off pipe has, also, a stop-cock which is placed in a vault on the down-stream side of the dam. A 12-inch by-pass pipe, provided with a stop-cock, is placed at the stop-cock of the blow-off pipe in order to reduce the pressure when this stop-cock is to be opened. On each side of the 48-inch stop-cock a 6-inch blow-off is placed at the bottom of the 48-inch pipe.

A 12-inch iron drain-pipe is laid from each of the circular wells in the masonry of the dam to the stop-cock vault, where it is connected with one of the blow-off pipes. This pipe begins at the bottom of the well with an elbow provided with a balanced valve, similar to that of the blow-off valve. From the south drain-pipe a 12-inch iron pipe is laid to a fountain, where it is connected to five vertical jet pipes, one of 6 inches and four of 4 inches diameter. The basin of the fountain has a diameter of 50 feet, and is connected by a 20-inch overflow- and discharge-pipe with the Croton River.

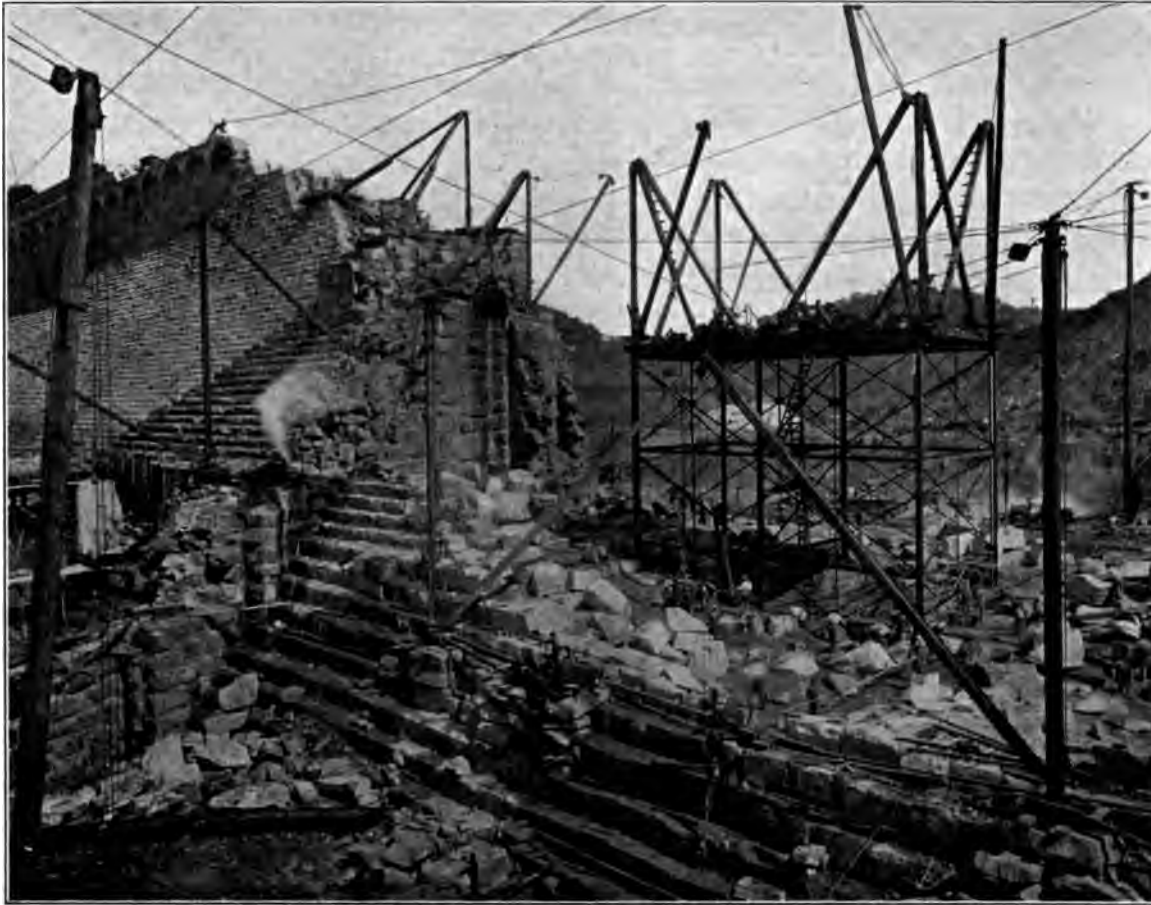
While the foundation of the dam was being constructed below the river-bed, the Croton River was confined in a new channel, 125 feet wide, constructed along the north hillside, as already described. When the masonry was carried up above the river-bed an arched relief opening was constructed in the masonry to permit the river to flow through the dam. The arched opening (Plate Q) was constructed at the new river-channel at about elevation 50. It was made 28 feet wide by 24 feet high at the up-stream face and 20 feet wide by 21 feet high at the down-stream face. The reduction in width and height of the opening was made by four offsets and the sides were "toothed" so as to bond with the concrete with which the opening was finally filled. After the opening had been filled with concrete, grout was forced through small pipes, imbedded in the masonry near the top of the opening, to fill any void spaces that might be found in the concrete.

Two 48-inch scour-pipes were imbedded in the concrete at the bottom of the relief opening. The flow into each of these pipes is controlled on the up-stream face of the dam by a  $2\frac{1}{2} \times 5$ -foot sluice-gate, which is operated by hoisting machinery placed on a small platform constructed at elevation 153, which can be reached from the top of the dam by means of a ladder. Ordinarily this platform is submerged and the scour-gates can only be opened when the water surface of the reservoir has been lowered by means of the three blow-off pipes to elevation 150. Each of the scour-pipes is provided at the down-stream face of the dam with a stop-cock having a 4-inch by-pass pipe with a stop-cock to relieve the pressure. A vault is built over these stop-cocks.

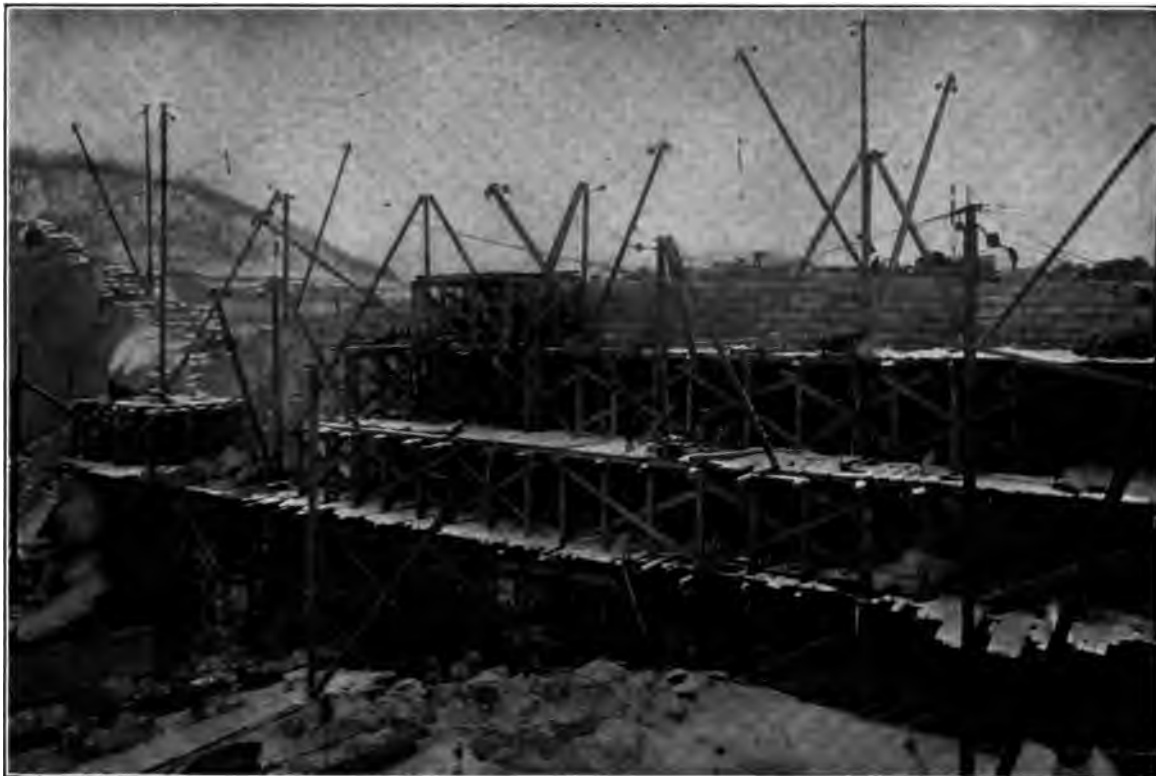
In order to provide an ample outlet for the Croton River during floods, and, also, to facilitate the transportation of building materials from one side to the other of the dam, a second arched opening was constructed in the dam at elevation 60, just south of Gate-house No. 2. This opening was 22 feet wide by 23 feet high at the up-stream face of the dam and 18 feet wide by 21 feet high at the down-stream face, the reduction in width and height being made by two offsets. The sides were toothed and the opening was finally closed with concrete, as in the case of the arched opening at the river-channel.



PLATE R.

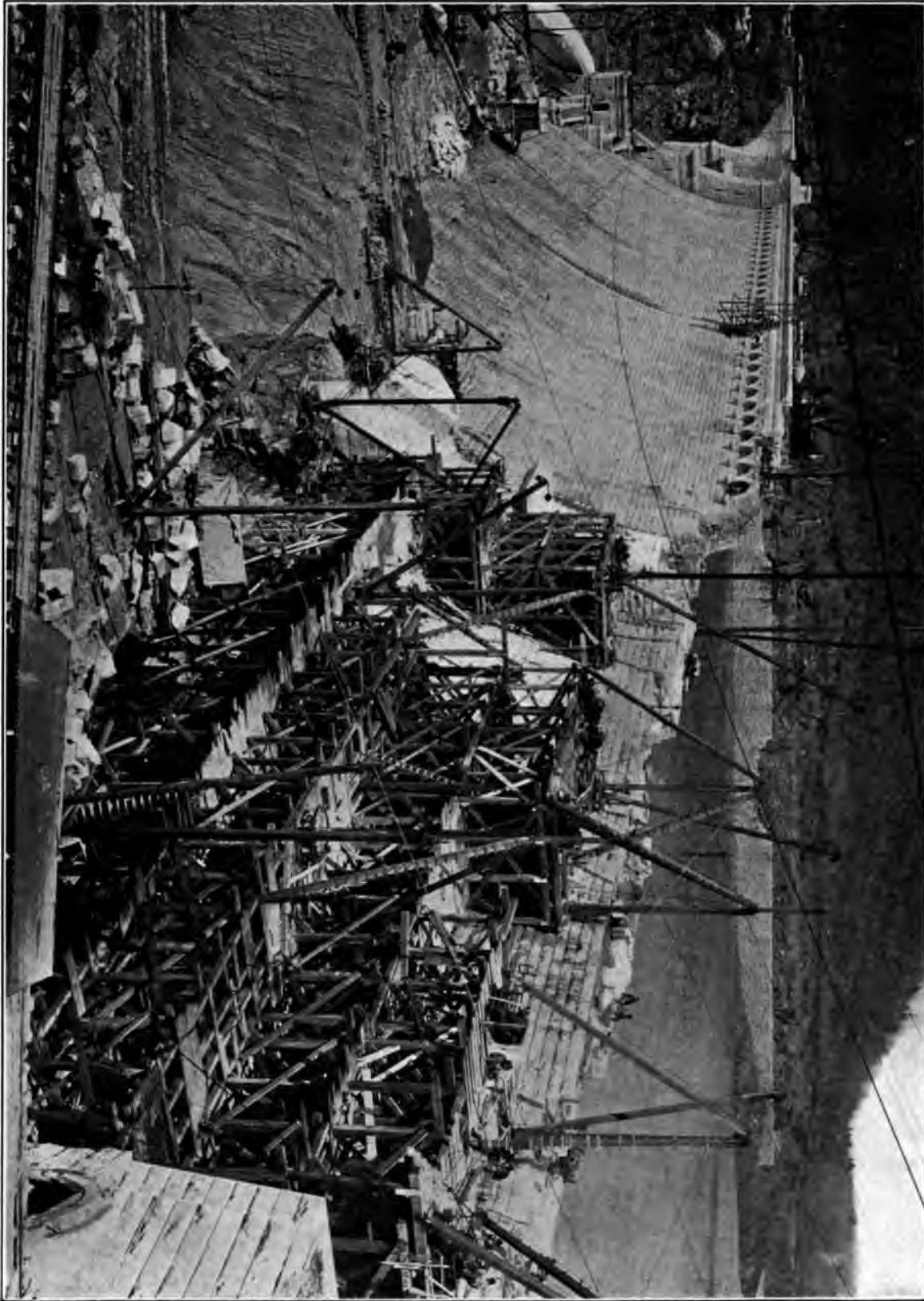


NEW CROTON DAM. DERRICK PLATFORM.



NEW CROTON DAM. TRESTLE ON DOWN-STREAM FACE.

1901



NEW CROTON DAM. BUILDING EXTENSION OF MASONRY DAMS.

11

No pipes were laid in the masonry, except the small pipes used for grouting the concrete.

On January 22, 1905, the scour and blow-off pipes of the dam were closed for the first time, and the reservoir was allowed to fill. By April 1, 1905, the water had risen in the reservoir to about elevation 170. It was not allowed to rise more than a foot or two above this level, as some refilling, etc., remained to be done, and in the following October the water was drawn down to elevation 55 to permit the contractors to complete their work. The last stone was laid in the dam on January 17, 1906.

A roadway 19½ feet wide, formed of concrete laid in sections 6 feet wide, was constructed on top of the dam. The front face of the dam was corbeled out near the top, in order to get the width required for the roadway. The drainage from this roadway is discharged by 8-inch vitrified pipes (placed at intervals of 114 feet on both sides of the roadway and provided with suitable gratings in the gutters) into a 4×4-foot sewer constructed in the masonry of the dam under the roadway. Iron railings are placed on both sides of the roadway, except at the buttresses and pilasters, where stone parapets are built. The railing consists of wrought-iron pipes with cast-iron post caps, bases, and special channels. The railing has panels 9½ feet long between the centres of posts and is 4 feet high above the masonry base. Each post is anchored by 4-inch bronze bolts to the masonry, the bolt-holes being grouted with Portland cement. All ironwork was galvanized and given three coats of paint after being erected.

The roadway is carried across the waste channel by a steel arch bridge of 200 feet span.

**Contractors' Plant.** — The contract for the New Croton Dam included, in addition to the work of the dam, the construction of 21 miles of new highways and the repairs and reinforcement of 3 miles of the Old Croton Aqueduct that were to be submerged by the reservoir. The principal items of the plant used by the contractors on this work were:

- 11 locomotives for 36-inch gauge.
- 82 flat cars for 36-inch gauge.
- 200 dump-cars for 36-inch gauge.
- 750 tons of steel rail (30-40 pounds per yard).
- 3 steam-shovels (bucket 1½-2½ cubic yards).
- 1 dredge, 80 feet boom, 3 cubic yards bucket.
- 39 steam-boilers, total capacity 1,400 H.P.
- 15 steam-pumps, total capacity 20,000,000 gallons per day.
- 51 hoisting-engines.
- 11 steam-engines, 10-50 H.P.
- 20 steam-drills.
- 75 derricks (boom, guy, and stiff-leg).
- 3 cableways, 1,250 to 1,650 feet long, with engines, etc.
- 3 stone-crushing plants.
- 8 concrete-mixing machines, etc., etc.

The pumping-plant required for the foundation-trench consisted of three Worthington compound pumps, each having a nominal capacity of 4,000,000 gallons in twenty-four hours against a head of 90 feet.

**Force Employed, etc.**—When the construction was at its height the contractors employed a force of about 1,564 men. In performing the work covered by their contract, including highways, etc., the contractors used about 381,000 barrels of American cement, 365,000 barrels of Portland cement, and 125,000 tons of coal. All of this material had to be hauled by teams from Croton-on-Hudson to the dam, a distance of about  $2\frac{1}{2}$  miles, as the contractors were prevented from building a railroad from the New York Central and Hudson River Railroad to their work on account of charters that had been obtained by private parties, who wished to sell these charters to the contractors at exorbitant prices.

**Engineers.**—The plans for the New Croton Dam were prepared by the late A. Fteley, Past President Am. Soc. C. E., Chief Engineer of the Aqueduct Commission. The construction of the work was carried on under the direction of Mr. Fteley from September 1, 1892, to January 1, 1900, when he resigned on account of ill health. W. R. Hill, M. Am. Soc. C. E., succeeded Mr. Fteley as Chief Engineer and directed the work of construction until he resigned on October 14, 1903. J. Waldo Smith, M. Am. Soc. C. E., was appointed on October 15, 1903, Chief Engineer of the Aqueduct Commission and served in that capacity until August 1, 1905, when he resigned. Walter H. Sears, M. Am. Soc. C. E., was placed in charge of the work as Acting Chief Engineer, and on January 9, 1906, the Aqueduct Commissioners appointed him Chief Engineer.

Charles S. Gowen, M. Am. Soc. C. E.,\* was in immediate charge of the work as Division Engineer from the beginning of the construction until August 31, 1905, when he resigned. On October 15, 1905, Mr. Frederick B. Rogers was appointed as Mr. Gowen's successor.

The following Assistant Engineers were in immediate charge of the construction of the dam under the direction of the Division Engineer: B. R. Value, September 1, 1892, to June 1, 1900; F. B. Rogers, June 1, 1900, to October 15, 1905; C. E. Smith, October 15, 1905, to completion.

**Contractors.**—The contract for constructing the New Croton Dam was awarded on August 26, 1892, to James S. Coleman, the lowest bidder, at his bid of \$4,150,573. Mr. Coleman assigned the contract for the construction of the dam on January 2, 1895, to the firm of Coleman, Ryan & Brown, who on July 13, 1899, assigned the contract to Coleman, Breuchaud & Coleman. The original contractor, James S. Coleman, was the senior member of both of the firms mentioned above.

**The Indian River Dam, New York,**† was constructed in 1898, on a tributary of the Hudson, to increase the size of Indian Lake in order to store an additional quantity of water to supply the Lake Champlain Canal, to add to the water-power, and to improve the navigation of the Hudson River.

The central part of the dam, which is constructed of masonry, is 207 feet long. It is 7 feet wide at the top and 33 feet wide at the base, its extreme height being 47 feet. The masonry dam is continued by an earth embankment, 200 feet long, having a masonry

---

\* Mr. Gowen has described the construction of the foundations of the dam very fully in a paper read before the American Society of Civil Engineers (see Vol. XLIII., p. 469), and has discussed the important changes made in the plans by substituting a masonry dam for the proposed earthen dam in a second paper read before that Society on January 18, 1906.

† *Engineering News*, May 18, 1899.

core-wall. This embankment is 15 feet wide on top and has an inner slope of  $2\frac{1}{2}$ :1 paved with 12 inches of stone riprap, and an outer slope of 2:1. The core-wall, which is carried up to within 2 feet of the top of the embankment, is 2 feet thick at the top and 4 feet thick at the base.

On the other side of the masonry dam, a masonry waste-weir, 106.5 feet long, is constructed. It is crossed by a foot-bridge resting on five masonry piers. A logway, 15 feet wide, is constructed in the masonry with its crest 17 feet below the top of the dam. This opening can be closed with 45 wooden needle beams ( $4'' \times 8'' \times 20'$ ) which are handled by block and tackle.

The dam has two 50-inch steel pipes, controlled by Eddy flume gates, which are placed in a tower built on the up-stream face of the dam. On the reservoir side of these gates auxiliary wooden sluice-gates are placed. The tower can be filled with water by means of a 6-inch by-pass pipe, which relieves the wooden gates of pressure so that they can be readily raised.

The reservoir formed by the dam floods an area of 5,035 acres and stores 33,500,000,000 gallons. It is supplied by a watershed of 146 square miles.

The dam was built for the Forest Reserve Board of New York State by the Indian River Company. The plans for the work were prepared by Geo. W. Rafter, M. Am. Soc. C. E.

**The Wachusett Dam** \* was constructed in 1900-1906 on the south branch of the Nashua River to form a storage reservoir, having a capacity of about 63,000,000,000 gallons, for the Metropolitan District of Boston, Massachusetts. In addition to this dam two earthen dams were constructed at low points in order to retain the water in the reservoir. From the masonry dam an aqueduct 12 miles long, known as the Wachusett Aqueduct, was built to connect with the older water-works supplying the district.

The masonry dam was located in a narrow rock gorge that has a width of about 100 feet at the bottom of the valley and a width of 1250 feet at the level of "full reservoir." The site selected for the dam was examined by numerous diamond-drill and wash-drill borings, and the results obtained were carefully studied by a geologist.

The dam is composed of a main dam of masonry, 971 feet long, including terminal structures; a masonry waste-weir, 452 feet long, at the northwesterly end of the main dam; and an earthen dam with masonry core-wall, 53 feet long, at the southeasterly end of the dam. The total length of the structure is 1,476 feet.

Plate LXXXIV, Fig. 1, shows the construction of the dam. The main dam has a length of 850 feet between terminal structures. It has a maximum height of 228 feet above the lowest point of the cut-off trench and a height of 114 feet above the restored surface in front of the dam. The minimum thickness of the dam is  $22\frac{1}{2}$  feet at a level 9 feet below the top of the dam, but the thickness is increased above this level by corbeling so as to be 25' 9" at the top of the dam, in order to provide sufficient room for a roadway. The top of the dam is given a super-elevation of 20 feet above the level of "full reservoir."

An examination of the profile of the dam shows that its area is considerably larger

---

\* See Annual Reports of the Metropolitan Water and Sewerage Board of Massachusetts; also *Engineering News*, Sept. 13, 1900.

than that of other masonry dams of similar height. This increase of area resulted from taking into consideration in the calculations an upward pressure of water under the base of the dam. The adoption of the large area of profile, which resulted from this rather extreme assumption, was partly due to the desire to provide a very large factor of safety for a location where very great damage would result from the failure of the dam. Clinton, a town of 13,000 inhabitants, is situated only about half a mile below the site of the dam.

**Terminal Structures.**—The main dam terminates at its northwesterly end in a circular bastion, having an outer diameter of 50 feet, and at its southeasterly end in a semicircular abutment. A room with concrete walls and granolithic floor was constructed in the bastion and serves as a storage-place for the flashboards of the waste-weir. A flight of stone steps leading from the ground to the top of the dam is built on the down-stream wall of the bastion.

The abutment is carried out a short distance into the reservoir beyond the natural flow-line in order to improve the appearance of the structure and to diminish the cost. The floor of the abutment is made of reinforced concrete resting on beams of similar construction, which are supported by six concrete piers. From the abutment to the shore the core-wall of the earth dam is built for a length of about 53 feet. The abutment is flanked by retaining-walls and backed by a large earth embankment.

A terraced path, with frequent short flights of stone steps, leads from each terminal structure to the roadway constructed in front of the dam across the valley.

**The Waste-weir** has a total length of 450 feet. In order to get sufficient length for the weir, it was located from the bastion on an angle of  $56^{\circ} 46'$  with the line of the main dam for a distance of 350 feet, and was then turned to the hillside nearly parallel with the main dam, for a distance of 100 feet. For the first 100 feet from the bastion, the waste-weir was finished 3 feet below the full reservoir level, the remainder of the weir being carried up to this level. A foot-bridge was constructed over the waste-weir, 7 feet above the full-reservoir level. It is supported by heavy cast-iron standards, placed 10 feet apart, which have grooves for stop-planks, by means of which the depressed part of the weir can be raised to the level of "full reservoir." The space occupied by the iron standards reduces the net length of the waste-weir to 419 feet.

Provision is made for flashboards over the whole waste-weir to an elevation of 3 feet above the full-reservoir level. This is not done to raise the reservoir above the normal level, but to prevent the loss of water from waves dashing over the crest. The flashboards are removed in winter, when the reservoir is frozen.

The crest of the weir is rounded sufficiently on the down-stream side to cause the water to follow the masonry. Below the rounded crest the down-stream side of the weir has a facing of ashlar, which is broken towards the bottom into steps to receive the impact of the falling water. A paving of coursed granite was laid above the waste-weir for its whole length. It is usually in 2-foot courses having a depth of 18 to 24 inches. This paving is 25 feet wide and is laid on a 1:3 slope. Below this paving, a paving of uncoursed quarry-stone extends to the original surface of the ground.

With the flashboards on the depressed portion, the waste-weir will discharge in 24 hours, with a depth of 5 feet on the crest, a quantity of water equal to 4.9 inches of water over the whole watershed, which has an area of 119 square miles. Taking the effect of the storage in the reservoir into account, it is expected that a run-off of 8 inches in 24 hours will not raise the



PLATE T.



WACHUSETT DAM



WACHUSETT DAM.



water more than 5 feet above the crest of the waste-weir, assuming the water to be at the level of this crest at the beginning of the freshet.

**The Waste-channel.**—A favorable natural location was found for the waste-channel on the northwesterly side of the valley. The slopes rise rapidly from the river on both sides of the valley, but on the northwesterly side there is a nearly level bench a short distance below the full-reservoir level, and down-stream of the bench there is a valley leading to the river about 800 feet below the dam. The waste-channel was located on the bench and in this valley. It was excavated partly in earth and partly in rock. In order to reduce the velocity of the discharge into the river, the waste-channel was given more width and less depth at its terminus. For about 500 feet from the bastion a retaining-wall, founded on rock, was built to prevent the flood-waters from scouring away the earth which the wall retains.

**Pipes through the Dam.**—Four 4-ft. cast-iron pipes were laid through the dam at elevation 284 (Boston datum, which is approximately mean low tide at Boston). They supply the aqueduct and turbines below the dam and waste the water when required. For the full reservoir these pipes have a capacity of wasting 2500 cubic feet per second, a draft which lowers the reservoir 1.25 feet per day if no water flows into it.

**Upper Gate-chamber** (Plate LXXXV).—The inlet into the four discharge-pipes mentioned above is controlled in a gate-chamber, constructed in the masonry of the dam and in a projection at the up-stream face. Two vertical wells are provided for each pipe. The up-stream well contains the sluice-gates, and the down-stream well conveys the water that has passed the gates to the discharge-pipes. At the level of the bottom of the discharge-pipes (elevation 284) the two wells for each pipe are joined by a short piece of 4-foot pipe, provided with a stop-cock, through which the water back of the dam was discharged during the construction until it rose to elevation 330, the level of the bottom of the lowest inlet-opening of the gate-chamber. So soon as the water reached this level the use of the small pipes at the bottom of the wells was abandoned, their stop-cocks being closed. The lower part of each up-stream well was then closed by a floor, constructed a little below the bottom inlets. The upper part of each inlet-well contains two  $2\frac{1}{2} \times 6$  foot sluice-gates, one just above the floor and the other one half-way up. Under ordinary conditions the upper gates are only under a head of 30 feet, when the reservoir is full, and they can be opened first to reduce the pressure on the lower gates. The latter can, however, be successfully operated under the maximum head to which they can be exposed (about 62 feet head).

Each up-stream well has six inlet-openings, each 8 feet high by  $2\frac{1}{2}$  feet wide. They are provided on the reservoir side with coarse screens to prevent large pieces of water-logged wood from entering the well. The grooves in which the screens are placed are continued to the bottom of the discharge-pipes and may be used, if required, for guiding drop-gates for closing the opening of the short 4-foot pipes at the bottom of the wells, which discharged the water during the construction. On the down-stream side of the inlet-openings three pairs of grooves are provided for stop-planks or screens. They have 30 inches between faces and extend from the top of the dam to the floor at elevation 330. The narrow width of the inlets (viz.,  $2\frac{1}{2}$  feet) was adopted with a view of using comparatively thin stop-planks, fastened together in sections of 10 feet, without making them too heavy for convenient handling.

As the top of the dam is 20 feet above the full reservoir level, the room from which the gates, etc., are operated was constructed below the level of the top of the dam, the

up-stream face being corbeled out. The floor of this room, which is  $2\frac{1}{2}$  feet above the flow-line, has a granolithic finish. The sides are lined with face-brick. The roof is made of concrete. An electric traveling crane is provided for handling the stop-planks, screens, etc.

**The Lower Gate-chamber** (Plate LXXXV), which serves as a head-house for the aqueduct, and also as a power-house for utilizing the fall of the water from the reservoir into the aqueduct, is located immediately below the dam. This gate-chamber is divided into four rectangular wells through which each 4-ft. discharge-pipe passes. In the first well, which is dry, each 4-ft. discharge-pipe is connected by means of a "cross" with two 2-ft. branch pipes, each provided with a stop-cock for regulating the flow of the water into the aqueduct. The 2-ft. branch pipes are all connected in the second well with a 4-ft. perforated pipe, known as the diffuser. The second and third wells contain the feed-pipes of the turbines, which are located at a higher level, and also the discharge-pipes from the turbines. The fourth well, which is ordinarily dry, contains a 4-ft. gate for each of the four discharge-pipes. If more water should be discharged, by accident, than the aqueduct can carry, the surplus water overflows into the fourth well and is carried off through two 5-ft. pipes, without gates, into the waste-conduit. All the wells of the gate-chamber are provided with drain-pipes that lead to a pump-well at a low level, constructed at one end of the fourth well.

**Waste-conduit and Pool.**—Immediately below each 4-ft. gate in the fourth well of the lower gate-chamber, each discharge-pipe increases in diameter at the rate of 1 foot in 10 feet until it has a diameter of 8 feet. It is then continued by a concrete conduit whose diameter increases at the same rate until it is 10 feet.

By diverging the discharge-pipes, as explained, their capacity is increased and the velocity of the discharge is reduced. For a velocity of 50 feet per second in the 4-ft. pipes the discharge at the end of the diverging conduit is only about 8 feet per second.

The four diverging conduits are continued by four concrete conduits, each 10 feet in diameter. These conduits are built, side by side, to a central waste-pool, 56 feet in diameter. Here the two outer and the two inner waste-conduits are connected, respectively, by two annular concentric passages, with flat bottoms and arched tops, which form the substructure of the central pool. The roofs of these passages are pierced by large holes through which the waste water discharges into the central pool at low velocities. The outer passage has 12 holes, each 6 feet in diameter, while the inner one has only 7 holes, each 7 feet in diameter, and 2 holes, each 6 feet in diameter. The areas of the passages are reduced as the holes in the top are reached, in such a manner that the water will be forced through all holes nearly at the same velocity.

The central pool into which the water rises is surrounded by a stone curb, 4 feet high, over which the water flows into an outer pool, 150 feet in diameter, whose floor is at the same level as that of the inner pool. The outer pool is surrounded by a retaining-wall, 7 feet high, except on the down-stream side, where a spillway, 110 feet long, is provided, over which the water discharges into the river. The pools can readily be drained for inspection by operating the drainage-pumps.

**Protective Works.**—Before the contract for the Wachusett Dam was let the Metropolitan Water and Sewerage Board of Massachusetts, under whose direction the works were built, had the excavation of the foundation-trench for the dam begun by day's labor and also constructed two wooden flumes to carry the water of the river past the dam during the construction. A small earth dam was built across the river, about 275 feet above the site of the dam, to

divert the water into the flumes. A small flume, 7' 2" wide by 7' 7" high, was constructed from the earth dam to the head of the Wachusett Aqueduct in order to supply this aqueduct with water during the construction of the masonry dam. A large flume, 40 feet wide, 16 feet high at the up-stream and 13 feet high at the down-stream end, was built to take care of the water during freshets. The large flume had a length of about 700 feet. About half-way it had a bend of about  $8\frac{1}{2}^\circ$ . A second earth dam was constructed across the valley at the lower end of the large flume, in order to protect the foundation-trench from backwater.

The large flume was lined with very smooth planks and was designed to carry 9000 cubic feet per second. It was expected that with this flow there would be a loss of 4 feet head at the entrance of the flume and a depth of water of 15 feet at the upper end which would diminish to less than 13 feet at the lower end.

The smaller flume was placed, where it crossed the site of the dam, in a trench 40 feet deep, on solid rock, and was not undermined by the construction. The larger flume was supported by posts at the crossing of the foundation-trench.

Two severe freshets occurred early in 1900, which proved the capacities of the flumes to be sufficient. One of these freshets was the greatest on record, being caused by unusual conditions. According to measurements taken 1.65 miles below the site of the dam, this freshet caused a flow of about 9050 cubic feet per second from a watershed of 119 square miles, corresponding to 2.83 watershed inches in 24 hours. This flow lasted only for two hours. The total flow for 24 hours averaged 6390 cubic feet per second.

**Details of Construction.**—In excavating the foundation-trench, sand and gravel were encountered for about 30 feet below the river-bed. Below this level, for about 20 feet to bed-rock, for the greater part of the trench, large and small boulders, packed closely together, with the interstices filled with cemented gravel, had to be excavated. Some of the boulders were very large, one containing 621 cubic yards.

The excavation was begun with slopes of  $1\frac{1}{2}:1$ , but on the down-stream side the boulders and cemented gravel were so firm that part of the excavation was made with a nearly vertical slope. A berm of about 20 feet was made on the bed-rock on the up-stream side of the trench, a similar berm 15 feet wide being made on the down-stream side. The maximum width of the excavation at the top of the trench was 376 feet, the greatest width at the surface of the ledge rock being 211 feet.

When the rock was uncovered, it was found to be schist on the easterly side of the gorge, sometimes gray and quite hard, and at other places black and rather soft. The rock on the westerly side is granite. The junction of the schist with the granite was perfect in nearly all cases, and both kinds of rock were found to be water-tight and strong enough to resist the pressure to which they were to be subjected by the dam.

The excavation was continued into the rock for a sufficient depth to obtain a solid foundation nearly free of seams. The average depth of the excavation in the rock was about 13 feet and a cut-off trench, 20 feet wide, was excavated for an additional depth of about 14 feet. In order not to disturb the walls of the cut-off trench, lines of 3-inch holes, 5 inches apart on centres, were drilled to the bottom of the cut-off trench, and the rock in the centre of this trench was removed by careful blasting. Large steel wedges were used in the side holes for removing the rock near the walls of the cut-off trench. A deep recess, about 20 feet wide, was cut by the same method, into the face of the granite cliff, with considerable difficulty.

The masonry dam and waste-weir were built wholly of rubble, with the exception of a thin facing of ashlar on the exposed faces. The rubble consists of large pieces of quarried granite, containing about 1 to 3 cubic yards, and laid generally in natural-cement mortar, mixed 1 part of cement to 2 parts of sand. For the foundation courses and for wet places, however, Portland cement mixed with 2 parts of sand was used. This kind of mortar was also used for a triangular section of the dam at the deepest part of the valley, having a base extending from the down-stream side to about 150 feet up-stream and a height of about 50 feet (Plate LXXXIV, Fig. 1), as this portion of the masonry is exposed to the greatest stress when the reservoir is full.

Those parts of the foundation-trench which were not filled with masonry were carefully refilled with earth. To insure water-tightness, about 10 feet in thickness of clayey material was filled against the up-stream side of the dam, and then an earth filling was carried up to a height of about 34 feet above the bottom of the river. The up-stream face of the rubble, against which the earth was to be filled, was made with specially selected stones, so as to have small joints, which were carefully pointed.

The ashlar face was not only adopted to give the dam a finished appearance, but principally because it can stand frost better than rubble and can be made more water-tight. On the up-stream face the ashlar has a thickness of 14 inches in the lower portion of the dam and of 12 inches in the upper part. Frequent headers tie the ashlar to the rubble masonry. On the down-stream face the ashlar has an average thickness of not less than 12 inches. In order to prevent as much as possible unequal setting between the rubble and the ashlar, the longitudinal joints of the latter were limited to a depth of 4 inches, and these joints were not pointed until after the dam was nearly completed.

The top of the dam was leveled off with concrete, about 5 inches below the finished surface, and was given a granolithic finish, 5 inches deep. A metal fence was erected on top of the dam, on each side.

The total quantity of masonry laid in the dam, including waste-weir and terminal structures, amounted to 273,000 cubic yards. The masonry was composed of 54 per cent large stones, 17 per cent spawls, and 29 per cent mortar. The largest amount of masonry for any week was laid in the week ending June 25, 1904, when 3459 cubic yards of rubble and 42 cubic yards of ashlar were laid by means of 11 derricks.

The following table gives the elevations of different parts of the dam, etc.:

Location.	Elevation.*
Lowest point of cut-off trench. . . . .	187
Lowest point of main trench. . . . .	208
Bottom of river channel. . . . .	269
Bottom of discharge-pipes in dam. . . . .	284
Top of dam. . . . .	415

**Contractors' Plant.**—Practically all the machinery used on the dam and in the quarry, including cableways, derricks, pumps, drills, etc., was operated by compressed air, which was furnished from a central station at the Central Massachusetts Railroad, located between the quarry and the dam. The compressor plant consisted of two cross-compound Rand air-

\* The elevations refer to Boston datum, which is approximately mean low tide at Boston.

compressors, operated by two compound condensing Corliss steam-engines, each rated at 500 horse-power. The diameters of the cylinders of the steam-engines were 18 inches and 34 inches, and the diameters of the air-cylinders of each compressor were 20 inches and 34 inches, the length of stroke being 42 inches. Two Cahall inclined water-tube boilers supplied the steam for the engines. The water required for cooling the compressed air, for condensing the steam, etc., was brought to the plant through a 3-inch pipe, about 3,550 feet long, from a pond having an area of about 26 acres, situated at a sufficient altitude. The waste-water was discharged into the far side of a reservoir, several acres in extent, and was used again, after passing through the reservoir, for cooling and condensing purposes. The main air-pipe, which was 8 inches in diameter, was made of wrought iron. A similar pipe, 6 inches in diameter, was laid to the quarry. The amount of power furnished varied considerably. It averaged about 600 horse-power for the day shift and about 370 horse-power for the night shift. The maximum amount used at any time was 850 horse-power.

The principal pumping-plant consisted of two 12-inch Worthington compound piston-pumps, one placed on the up-stream side and the other on the down-stream side of the foundation-trench of the dam. Most of the time the water was pumped from the trench into the large flume that conveyed the river past the site of the dam. The two Worthington pumps were capable of pumping all the water that reached the foundation-trench, but supplementary pumps were provided for emergencies, and additional small pumps were used for the cut-off trench and for other local pumping. The maximum amount of water pumped per day was about 4,000,000 gallons.

A branch track, 5,490 feet long, was constructed from the Central Massachusetts Railroad to the site of the dam. Part of this track served as the main track from the quarry. The rolling stock used consisted of a 60-ton, ten-wheel, standard-gauge locomotive, 29 flat and gondola cars, and four 4-yard dump-cars. Besides this, fifteen 3-ft.-gauge, 2½-yard cars were used for various purposes. The water required for the locomotives, mortar-mixing, washing the rock foundation, etc., was pumped from the river into a tank, placed 92 feet above it on the hillside. The water needed at the quarry was pumped at the central power-station into a tank located on a hill near the quarry, about 200 feet higher than the level of the river.

When the work was at its height, 8 derricks were used at the quarry and 8 derricks at the dam. Those at the quarry were unusually high, some having masts 82 feet high. The derricks at the quarry were operated by hoisting-engines having cylinders 7×10 inches, and those at the dam had hoisting engines with cylinders 5½×8 inches. All of the derricks were equipped with bull-wheels, which enabled the engineer to swing the derrick without the assistance of a tagman.

Two cableways were erected across the site of the dam and were used in making the excavation and laying the masonry. They had originally spans of 1,150 feet, which were increased, in 1904, to 1,250 feet.

The cement was stored in two storehouses having a capacity of 4,500 bbls. A sand-bin, having a capacity of 370 cubic yards, was built farther up the hill and was so constructed that the sand would run into small cars on either of two tracks, passing under the bin.

The quarry was located, about 1¼ miles from the dam, on land belonging to the Commonwealth of Massachusetts. It furnished a Muscovite granite, weighing 165 lbs. per cubic foot, of good quality for splitting and cutting. Its crushing strength was about the same as that of Cape

Ann and Quincy granite. All the rubble and part of the ashlar placed in the dam was obtained from this quarry. Most of the ashlar was procured from the quarry of H. E. Fletcher & Co. at Chelmsford, Mass. Excellent sand was obtained about  $\frac{3}{4}$  of a mile from the dam, on land belonging to the Commonwealth, and was handled by teams.

**The Contract** for the construction of the dam was given, on October 1, 1900, to McArthur Brothers Company of Chicago, the lowest bidders, at their bid of \$1,603,635. The work was begun on the following October 11th and completed early in March, 1906. The first and the last stones were laid on the dam, respectively, on June 5, 1901, and July 22, 1905. The total cost of the dam, including the engineering and the preliminary work done by day's work, amounted to about \$2,266,000.

**Engineers.**—The dam was designed and constructed under the direction of Frederick P. Stearns, M. Am. Soc. C. E., Chief Engineer of the Metropolitan Water and Sewerage Board. Alphonse Fteley, Joseph P. Davis, Members Am. Soc. C. E., and Hiram F. Mills acted as Consulting Engineers.

The mathematical studies and investigations for the dam were begun by Mr. Reuben Shirreffs, Principal Office Assistant, who resigned in 1899. He was succeeded by Alfred D. Flinn, M. Am. Soc. C. E., under whose direction the studies were completed and the contract drawings prepared. Thomas F. Richardson, M. Am. Soc. C. E., was the Resident Engineer in immediate charge of the work.

The profile adopted for the dam was determined by trial. It was made sufficiently wide to keep the lines of pressure within the centre third of the profile for reservoir full or empty, in the former case an ice pressure of 23.5 tons per lineal foot being assumed, and also an upward water pressure under the base of the dam. This upward pressure was taken to be equal to the full head of "reservoir full" for the width of the cut-off wall and was then assumed to be reduced to two thirds of this pressure and to diminish uniformly to 0 at the down-stream toe of the dam. The profile obtained from these rather extreme assumptions is much wider than usual, but was adopted as it was desired to give the dam an extra-large factor of safety on account of the apprehensions that were felt for the safety of the dam by the many persons living below its site.

**The Spier Falls Dam** was constructed in 1900–1905 across the Hudson River, about 9 miles southeast of Glens Falls, Warren County, New York. It forms a reservoir about  $5\frac{1}{2}$  miles long by  $\frac{1}{2}$  mile wide, giving 80 feet head of water. The water-power thus created is utilized to produce, by means of turbines direct-connected to dynamos, electricity which is supplied to neighboring cities. An intake-canal is constructed on the right bank of the river. From this canal the main dam extends for a distance of 552 feet across the river and is continued by an overflow-weir, 817 feet long, which is constructed across a sand and gravel plateau on the right bank of the river, its crest being 10 and 12 feet lower than the top of the main dam at the junction of the overflow-weir and the main dam. A wing wall, 10 feet wide and about 1500 feet long, is constructed on the down-stream side of the dam in order to prevent the water coming over the spillway from running into the tail-bay and raising the height of the tail-water. A smaller dam, 403 feet long, is constructed near the right bank of the river on the down-stream side of the main dam, and at right angles thereto, to form one side of the intake-canal.

The profile adopted for the main dam is shown in Plate LXXXIV, Fig. 2. The dam was constructed of large stones embedded in and surrounded by concrete, mixed in the proportion of 1 part of Portland cement, 3 parts of sand, and 5 parts of stone, and is faced with hammered



rubble, roughly coursed and laid in 1 to 2½ Portland-cement mortar. It has a maximum height of 154 feet. The dam along the intake-canal is built in the same manner as the main dam, with the exception that the face along the canal is finished in concrete on account of the many grooves, projections, and flaring entrances to the penstocks. This dam is pierced by ten 12-foot penstocks.

The overflow-weir is built according to the profile shown on Plate LXXXVII, Fig. 2, the down-stream face being an ogce curve and the up-stream face slightly battered. The interior of this weir is built of rubble masonry, consisting of granite rock, laid in 1 to 2½ Portland-cement mortar. The down-stream face is made of random-range ashlar, cut to ½-inch joints. The up-stream face is formed of hammered rubble. Special stones were cut for the toe and crest. These stones, which contain from 1½ to 3 cubic yards, are connected to each other and to the adjoining courses by 1½-inch iron clamps that are grouted in. The dam and overflow-weir were founded on clean, firm rock free from seams. To obtain this foundation the rock under the spillway had to be excavated to a considerable depth.

The drainage area of the river above the site of the dam has steep slopes and contain about 2700 square miles. The maximum flow of the river is about 40,000 to 50,000 cubic feet per second, and the minimum flow is about 1000 cubic feet per second. The spillway was constructed first, on the left or north bank of the river, on a plateau composed of boulders and gravel, rising about 35 feet above the river. Four 7×10-foot archways provided with gates were built in the spillway masonry, 35 feet above the old river-bed, to pass the river while the main dam was being constructed. These archways were able to discharge the extreme dry-weather flow. They were finally closed with masonry. Besides the archways a gap, about 90 feet wide and 40 feet deep, was left in the overflow-weir to discharge floods.

After the construction of the overflow-weir had been sufficiently advanced, a coffer-dam, about 900 feet long, was constructed across the river, from the right bank to the overflow-weir, to direct the water into the openings left in the weir. A smaller coffer-dam was run down the river, at right angles to the main coffer-dam, and the excavation was commenced inside of this protective work.

The river-bed consisted of a mass of boulders underlain in many places by cemented gravel and hard-pan. Ordinary sheet-pile coffer-dams could not be used, as piles could not be driven in such a bottom, and crib-work of logs was therefore resorted to. The main crib built was 600 feet long and 90 feet high. At its greatest cross-section it was 250 feet wide at the base and 80 feet at the top. The average widths of the crib were 150 feet at the base and 25 feet at the top, the average height being about 60 feet. After the crib-work was in place, a heavy fill of broken rock was made along its up-stream face, the largest stones being placed against the crib and covered with small stones. Gravel was dumped on the up-stream face of the rock-fill, and the material excavated for the foundation was placed on top of the fill. By this construction a practically tight protective work was obtained. When a leak started, the stones would settle and lodge, and the outer gravel-fill would then easily be held. After the main crib-work had been completed a 6-inch centrifugal pump handled the entire leakage. A gap, about 100 feet wide, was left at first in the main crib as a waterway to pass floods. It was crossed by a trussed bridge and was closed later by small cribs provided with sluiceways, which were finally closed. By means of the cribs described above the river was diverted to its left or north bank.

For details of how the dam was built the reader is referred to a paper by Charles F. Parsons in the Trans. Amer. Institute of Mining Engineers for 1903, the *Engineering News*, June 18, 1903, and *Engineering Record*, June 27, 1903.

The dam and works were constructed by the Hudson River Water Power Company of Glens Falls, New York, principally by day's labor. The works were designed by Charles F. Parsons, with the assistance of William Barclay Parsons, M. Am. Soc. C. E., and S. E. Evans, M. Am. Soc. C. E., as Consulting Engineers.

**The Boonton Dam\*** was constructed in 1900-1905 across Rockaway River, an affluent of the Passaic River, about three quarters of a mile east of the station of the Delaware, Lackawanna and Western Railroad at Boonton, New Jersey. The dam, which is constructed principally of masonry, forms, with an auxiliary dam of earth, a storage reservoir of 7,200,000,000 gallons available capacity for the water-supply of Jersey City. The total capacity of the reservoir amounts to 8,600,000,000 gallons. The reservoir, when full, covers about 800 acres, and is about two miles long by three-quarters of a mile wide. The spillway is at elevation 305.25 above mean tide, and the plane of the lowest available gravity draft is at elevation 259.75, the bed of the river at the dam being at elevation 200. The maximum depth of the water is 105 feet. A conduit which conveys the water from the reservoir to Jersey City has a length of about 23 miles and consists of a reinforced-concrete cut-and-cover conduit, steel pipe, and grade tunnels, laid on a hydraulic grade of 6 inches per mile, the water running with a free upper surface.

The main dam is a masonry structure, 2,150 feet long, which is flanked on each side by an earthen dam with concrete core-wall. These embankments are, respectively, 450 and 500 feet long, making the total length of the dam 3,150 feet. The masonry dam (Plates LXXXVI and LXXXVII) is 17 feet wide on top, 77 feet wide at the base, and has a maximum height of 114 feet above the foundation. A portion of the structure, 300 feet long, is constructed as a spillway, with its crest 5 feet below the top of the main dam.

The dam is founded on Triassic sandstone shales, the inclination of the stratification being almost at right angles to the "line of pressure" in the dam with the reservoir full. This rock is very uniform in character. A cut-off wall, 8 feet wide with an average depth of about 10 feet, was built into the rock a few feet inside the up-stream face of the dam.

The dam was built almost entirely of cyclopean masonry (large blocks of irregular-shaped stones, just as they come from the quarry, embedded in and surrounded by concrete). The concrete was mixed very wet in cubical mixers, the proportions of the ingredients being carefully watched and varied in accordance with the run of the crusher so as to produce a mixture free from voids. The average proportion of cement, sand, and stone in the concrete was 1:2 $\frac{3}{4}$ :6 $\frac{1}{2}$ . The backing-stones, which measured from  $\frac{1}{4}$  to 4 cubic yards, were washed upon platform cars as received from the quarry, lifted by a derrick, dropped into place in the concrete closely together, and thoroughly shaken with bars to insure proper bedding. The spaces between the large stones were filled with concrete in which spawls were placed to obtain as large a percentage of stone in the masonry as possible. Care was taken to have the stones break joints both vertically and horizontally.

The down-stream face is covered below elevation 245 with an earth embankment, seeded down. Below the top of this embankment the down-stream face of the dam is built of selected rubble, but above this level it consists of regular courses of ashlar, ranging from 36 to 18 inches

---

\* This description is based upon information furnished the author by Edlow W. Harrison, M. Am. Soc. C. E., Chief Engineer of the Jersey City Water Supply Company.

in thickness. The up-stream face is built of similar ashlar above the water-line and of selected rubble below this level. The mason work on the two faces was always kept 2 to 4 feet higher than the centre and served thus as forms for the cyclopean masonry.

The stone used both for the backing and ashlar facing is syenite, quarried about 4 miles north of the dam. For the concrete 1 part of cement was mixed with 9 parts of ballast of broken stone (the run of the crusher) and sand. The cyclopean masonry weighs 166 pounds per cubic foot, and consists of about half of concrete and half of stone. Very little skilled labor is required in laying this kind of masonry.

The dam was constructed with great rapidity, all the masonry being laid from May, 1892, to November, 1894. In fifteen working months 214,000 cubic yards of masonry were laid, the maximum quantities per day and per month being, respectively, 960 cubic yards and 21,000 cubic yards. The average amount of cement used was 0.68 bbl. per cubic yard for all kinds of masonry. The total quantity of masonry of all kinds laid in the dam is about 255,000 cubic yards, its average weight being 166 lbs. per cubic foot.

The flow from the reservoir to the aqueduct is controlled in a gate-house, built as an offset in the up-stream side of the dam, on the southern slope of the original valley. The gate-house has inlet openings at three different elevations (surface, intermediate, and lowest), and duplicate passages leading to wells. The head in the reservoir is broken in passing through the gate-house, and the delivery to the aqueduct is at a constant head, at the elevation of the lowest available supply draft.

The reservoir can be drained from the bottom by two 48-inch pipes, embedded in concrete in the masonry of the dam at elevation 205. The gates of these pipes are set in chambers which can be reached by two 60-inch steel pipes, built vertically into the masonry to the top of the dam. The stems of the gates are placed in these pipe-shafts and are operated from the top of the dam. Although the pipe-shafts are placed within 6 feet of the water-face of the dam, very little seepage enters them. Flap-valves in the waste-pipes, down-stream from the gates, provide for drainage of the shafts.

Notwithstanding its length the dam has shown very few temperature cracks, and very little leakage has occurred when the dam has been subjected to the full-reservoir head. The leakage has steadily diminished.

During the construction of the dam thermophones were embedded in the masonry in different places to determine the range of temperature in the interior of the dam during the setting of the mortar. The results thus obtained have not, at the present date, been fully completed and tabulated.

The auxiliary dam of the reservoir consists of an earth embankment with concrete core-wall, 3500 feet long, which was constructed on the divide of the watershed at the south end of the valley.

The general plans of the Boonton Reservoir were prepared under the direction of Edlow W. Harrison, M. Am. Soc. C. E., the Consulting Engineer of the Jersey City Water Supply Company, which had a contract for the construction of the new water-works for Jersey City. In April, 1902, Mr. Harrison was appointed Chief Engineer of the above-mentioned company and J. Waldo Smith, M. Am. Soc. C. E., was made Consulting Engineer. The detailed plans for the dam and reservoir were prepared, under the supervision of Mr. Harrison, by William B. Fuller, M. Am. Soc. C. E., the Resident Engineer in charge of the works. George G. Honness, Assoc. M. Am. Soc. C. E., had charge of the construction of the dam and reservoir as Division Engineer.

The construction of the dam was begun in the spring of 1900, and the excavation of the foundation of the dam and the quarrying of stone were prosecuted that year. Owing to financial difficulties in which the Jersey City Water Supply Company became involved, practically no work was done on the dam during 1901. In April, 1902, new interests took control of the contract for the construction of the water-works, and a subcontract for the completion of the dam was given to Joseph S. Qualey & Co., of New York.

**The Lake Cheesman Dam** \* was constructed in 1900-1904 to form a storage reservoir on the South Platte River for the water-supply of the city of Denver, Colorado. The dam and reservoir were constructed by the South Platte Canal and Reservoir Company, a subsidiary company of the Denver Union Water Company. The first plans for the works were prepared by C. P. Allen,

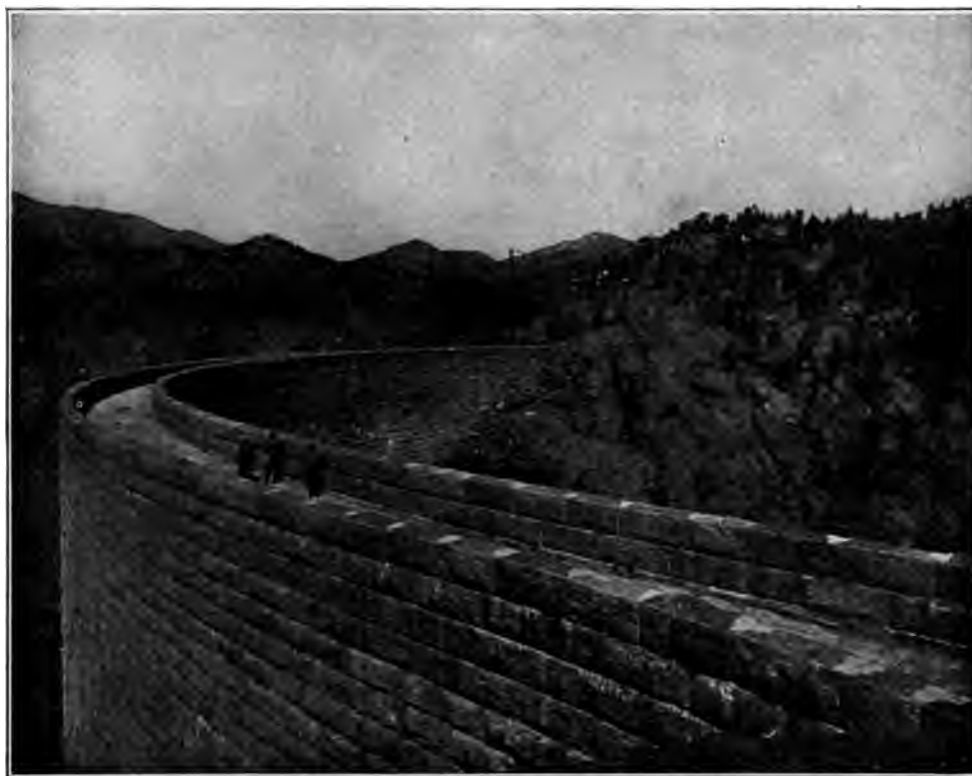


FIG. 39.—LAKE CHEESMAN DAM.

the Chief Engineer of the above-named companies, who recommended the construction of a rock-fill dam at a narrow canyon situated just below the junction of the Platte River and Goose Creek. This dam was to have a maximum height of about 220 feet, a top width of 15 feet, and slopes of  $\frac{1}{2}$  to 1 and  $1\frac{1}{2}$  to 1, respectively, on the up-stream and down-stream faces. The up-stream face was to be protected by stone, laid by hand, which was to be covered with 12 inches of concrete, upon which a steel plate was to be laid. This plate was to be attached to 6-inch I-beams, which were to be anchored into the rock-fill by  $\frac{1}{2}$ -inch rods 5 feet long, and it was also to be anchored into a footing of Portland-Cement masonry. The plan of the dam was to be straight.

\* See paper on the Lake Cheesman Dam and Reservoir, by Charles L. Harrison, in Trans. Am. Soc. C. E. for 1904, from which Fig. 39 is taken.

The construction of this dam was begun in 1898 and continued until May 3, 1900, when a flood occurred that overtopped the dam, which had been built to a height of about 38 feet, and destroyed it completely, with the exception of the masonry and the steel facing.

On June 1, 1900, Charles L. Harrison, M. Am. Soc. C. E., was appointed Chief Engineer of the above-mentioned companies and instructed to prepare plans for a new dam at the site originally selected, with the advice of L. E. Cooley, M. Am. Soc. C. E., as Consulting Engineer. At a later date an additional Consulting Engineer, Alfred Noble, Past-President Am. Soc. C. E., was appointed. Mr. Harrison remained in charge of the work until May 24, 1902, when he was succeeded by Alexander E. Kastl, M. Am. Soc. C. E.

Mr. Harrison and Mr. Cooley recommended the construction of a masonry dam having its plan curved up-stream, the radius of the up-stream face being 400 feet. The profile designed for the dam (Plate LXXXVIII, Fig. 2) was calculated to give the structure sufficient strength to resist the water pressure by gravity, and the plan was curved to add additional strength to the dam. The proposed plans were adopted, and the construction of the masonry dam was begun in September, 1900.

According to the plans adopted, the top of the dam was to be at elevation 210 (the datum plane being low water in the river at the site of the dam, which is 6644 feet above sea-level). After the dam had been brought up to elevation 100, it was decided to carry it up to a higher elevation than had been contemplated. Under the direction of the Consulting Engineers a number of sections for the dam were calculated by Silas H. Woodward, Assoc. M. Am. Soc. C. E., who made an interesting mathematical investigation of the action of a curved dam as an arch.\*

It was finally decided to finish the top of the dam at elevation 217 and the crest of the spillway at elevation 212. On account of the increase of 7 feet in the height of the dam, the thickness of the profile was slightly augmented above elevation 100.

**Details of Construction.**—The widths of the canyon at the site of the dam are as follows, at the down-stream face: at the bottom, about 30 feet; at elevation 30, about 40 feet; at elevation 90, about 130 feet; and at elevation 217, about 710 feet. The bed-rock is at elevation  $-10$  along the axis of the dam, with the exception of one pot-hole that extended down to elevation  $-15$ .

The bed-rock on which the dam was founded is granite, which was overlain by boulders and coarse gravel to a depth of about 8 feet. The entire bottom is a series of pot-holes 1 to 6 feet deep, eroded in the solid rock. Similar holes exist in the walls of the canyon up to elevation 50. The foundation was excavated to an average elevation of  $-10$ , the deepest point being at elevation  $-15$ .

The dam was built of gray granite, quarried about 2000 feet from the site of the dam. Portland cement, which was furnished by the Company free of cost to the contractors, was used in the mortar. For laying the stones in the up-stream face of the dam, in the foundation course, and at the ends of the dam, adjoining the solid rock, the mortar was composed of 1 part of cement to  $2\frac{1}{2}$  parts of sand. For the rest of the dam the cement and sand were mixed in the proportion of 1 to 2. At the faces the stones were laid, with 1-inch joints, in regular courses 2 feet thick. The exposed faces of the stones were not dressed, but the joints were rough-pointed. One fourth of the face area was composed of headers, 4 to 6 feet long, the remaining part being built of stretchers, varying from 3 to 7 feet in length. Large, well-shaped stones, about 2 feet thick, were

---

\* See "Analysis of Stresses in Lake Cheesman Dam," by Silas H. Woodward, in Trans. Am. Soc. C. E. for 1904.

used for the down-stream face. They were laid in steps, giving a good appearance for rough work. The interior of the dam was built of rubble, composed of good-sized stones, well shaped and breaking joints in all directions.

The dam has a width of 176 feet at the foundation (elevation - 10), and a width of 18 feet from elevation 190 to the top. The maximum height of the dam above the lowest point in the foundation (elevation - 15) is 232 feet. A stone parapet, 4 feet high, is built on each side of the top of the dam. In excavating the foundation of the dam, 26,000 cubic yards of earth and rock were excavated, and in building the dam 103,000 cubic yards of masonry were laid.

**The Spillway**, which is about 300 feet long, was constructed in a natural saddle in the rock ridge, and was made partly by excavation and partly by building walls, 14 feet wide on top. Its crest is at elevation 212. The south end of the spillway is about 200 feet north of the north end of the dam.

**The Outlets of the Reservoir** consist of three tunnels, driven through the granite mountain, at elevations 10, 60, and 110, and controlled by suitable gates.

**The Ithaca Dam**, New York, was built in 1903 on Six Mile Creek, about two miles from the centre of Ithaca, to form a reservoir for the water-supply of that town. The dam is built in a narrow rock gorge that is about 90 feet wide at the level of the creek.



FIG. 40.—ITHACA DAM.

The rock, which is a bluish-gray shale, rises, at the site of the dam, on the east side of the gorge to a height of about 90 feet, overhanging in its rise 4 or 5 feet, while on the west side it is only about 70 feet high and recedes 6 feet in this height.

Owing to the narrowness of the gorge in which the dam was located the designer of the works, Prof. G. S. Williams, M. Am. Soc. C. E., decided to build a curved dam, but instead of following the usual type he designed the dam somewhat like part of a spherical dome (Fig. 40).

A full description of this dam and of the theory upon which its design was based is given by Mr. Williams in Trans. Am. Soc. C. E., Vol. 53, p. 183.

The dam was to have a height of 90 feet. Although the plans were approved by a number of prominent engineers, the fears entertained by the citizens of Ithaca, that the proposed overhanging dam might give way and cause a great loss of life and property,

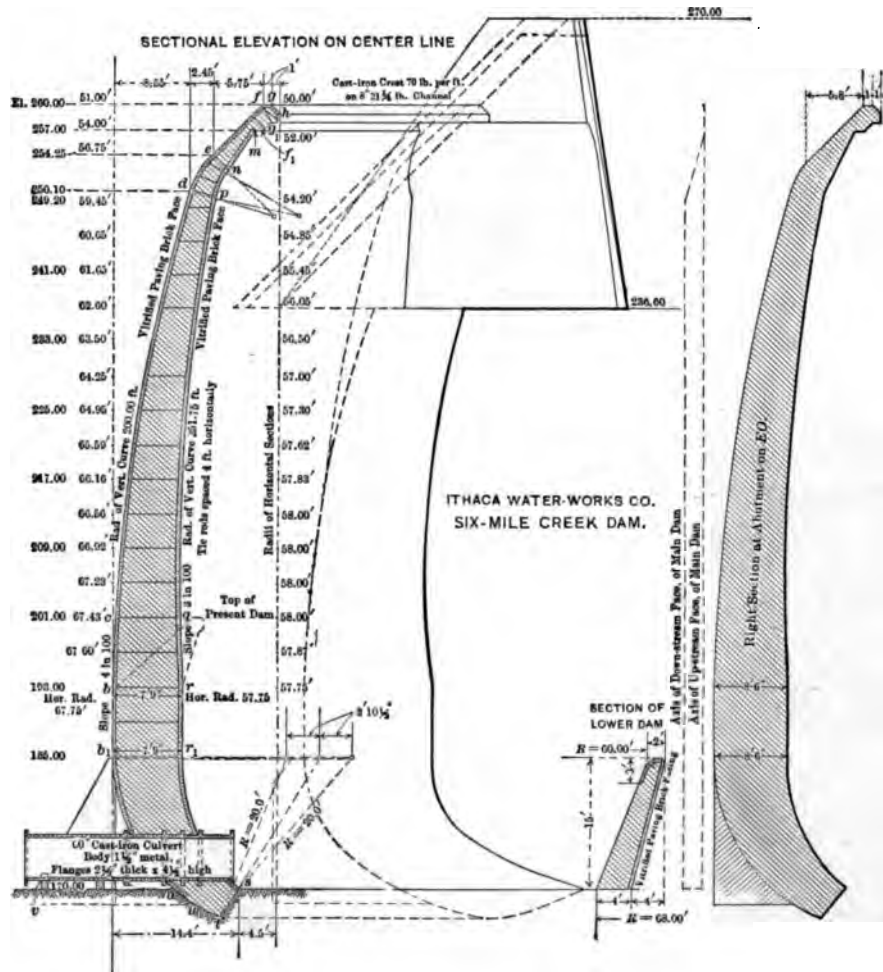


FIG. 41.

induced the water company that was building the dam to reduce its height to 30 feet. It was built according to the original plans to elevation 193, Fig. 41, and was finished at elevation 201, with a crest 60 feet in radius, overhanging on the down-stream side and having a 45° up-stream slope.

The body of the dam is made of concrete composed of 1 part of imported Alsen's cement, 2 parts creek sand, 2 parts gravel, and 2 parts broken stone from drift boulders, crushed to pass through a 4-inch ring. This concrete is faced on each side of the dam by a single course of vitrified paving brick, laid in Portland-cement mortar and anchored

into the body by bent steel anchor-bolts ( $1\frac{1}{2} \times \frac{1}{2} \times 7$  inches) turned up  $\frac{1}{2}$  inch at each end and placed at every fifth brick in every fifth course. A 3-inch mortar face of the same composition as that used for laying the bricks is placed between the brick facing and the concrete. Bands of  $\frac{3}{8} \times 3$ -inch steel are placed in this mortar, about 1 inch from the brickwork, for every 4 feet in height. These bands extend around the structure and are united through the dam every 4 feet horizontally by  $\frac{1}{2}$ -inch steel rods having a nut on each side of the bands. At elevation 185 the band on the up-stream side is made of  $\frac{3}{4} \times 4$ -inch steel and connected as described above to the  $\frac{3}{8} \times 3$ -inch band on the down-stream face, to provide for possible tensions from pier to pier when the pond is empty. Over the steel frame described above a netting of crimped  $\frac{1}{8}$ -inch longitudinal and  $\frac{1}{2}$ -inch vertical wire of 4-inch mesh was laid, extending on each abutment from face to face, and lapped one mesh and wired together at the horizontal joints of the sheets.

All iron and steel was dipped in grout as soon as it arrived on the work in order to prevent rusting.

The bands and netting were placed as close to the outer face as possible, in order to distribute stresses due to changes of temperature, thus preventing local cracks.

The foundations of the dam extend down 5 to 6 feet to solid rock. For a short distance the foundation was laid 18 feet below the river-bed.

The watershed of the creek above the site of the dam contains about 48 square miles. During the construction of the dam provision had to be made for carrying the stream through the work, as it could not be diverted. This was done by placing a 5-foot cast-iron pipe, controlled by a gate, in the base of the dam and by leaving, in addition, openings in the base. These openings were finally closed at a time of low water, when the creek could be discharged through the 5-foot pipe.

The dam was built for the Ithaca Water Works Company under the direction of the designer, Prof. G. S. Williams, M. Am. Soc. C. E., Messrs. Tucker & Vinton of New York being the contractors.

**The Granite Springs Dam\*** was built in 1902-1905 to form a storage reservoir on the Middle Fork of Crow Creek, a tributary of the South Platte River, for the water-supply of Cheyenne, Wyoming. The reservoir covers 185 acres and stores 1,734,000,000 gallons.

The dam is 96 feet high above bed-rock, 10 feet wide at the top and 56 feet wide at the base. Its length is 410 feet at the crest and 10 feet at the base. The dam is founded on granite and is built of uncoursed rubble, laid in Portland-cement mortar, according to a "gravity section." The plan is curved to a radius of 300 feet to provide additional strength and resistance to expansion and contraction. A parapet-wall, 2 feet thick and 3 feet high, is built on top of the dam on each side. The spillway is constructed in a depression at the lower end of the reservoir and is independent of the dam.

The dam contains 14,422 cubic yards of masonry, weighing on an average 177 lbs. per cubic foot. The outlet is formed by a 24-inch cast-iron flanged pipe, which is laid on bed-rock, 12 feet above the creek-bed.

The dam was designed and built under the direction of A. J. Wiley, M. Am. Soc. C. E., Chief Engineer. G. W. Zorn was in immediate charge of the construction as Resident

---

\* *Engineering News*, June 29, 1905.





A sand-crushing plant was also installed to crush dolomite limestone into sand, as experiments showed that mortar mixed with the crushed stone was stronger than that mixed with ordinary sand, and because ordinary sand will not be available when the dam is above the water.

Six  $4\frac{1}{2} \times 10$ -foot gates are to be placed in the outlet-tunnel, mentioned above, and will be used for sluicing purposes and for regulating the flow of water out of the reservoir. The gates will discharge the water directly into the Salt River, and about 50 miles down-stream a diversion-weir will distribute the water into the irrigation channels. The gates and their operating machinery will weigh nearly 800,000 pounds. The pressure on each gate will be about 800,000 pounds (viz., 100 pounds per square inch). With the reservoir full, the six gates will be capable of discharging about 10,000 cubic feet per second.

A power-canal, nearly 19 miles long, having a capacity of 200 cubic feet per second, has been constructed to convey water from above the reservoir to a point below the dam, where it is discharged through turbine wheels under an available head of 226 feet. The power thus obtained is to be used for operating the cement-mill during the construction of the dam, and in pumping ground-water for irrigation in the Salt River Valley.

At the foot of the dam a power-plant was built to contain hydraulic and electrical machinery for utilizing both the energy from the power-canal and that stored in the water in the reservoir. It is intended to draw down the water in the reservoir to the 80-foot level through pipes connecting with water-wheels. The power thus developed will be transmitted from 50 to 70 miles to the Salt River Valley, where it will be used for operating centrifugal pumps for raising the underground water to irrigate the district not covered by canals.

The nearest town, Globe, is 40 miles from the site of the dam, and 20 miles of new road had to be constructed to reach it. A freight road, 60 miles long, was built to connect the works with the Salt River Valley, where freight rates are very low. About 110 miles of new roads will have to be built in connection with the Salt River Reservoir.

The contract for the construction of the dam and reservoir was awarded to John M. O'Rourke & Co. of Galveston, Texas, and was signed by the Secretary of the Interior on April 8, 1905. Up to November 1, 1906, 22 per cent of the work had been performed.

The whole system of dams, canals, distribution, etc., which is known as the Salt River Project, is being constructed under the direction of the United States Reclamation Service, of which A. P. Davis, M. Am. Soc. C. E., is Chief Engineer.\* The dam was designed by Mr. F. Teichmann, under the direction of a board of engineers consisting of A. P. Davis, George Y. Wisner, W. H. Sanders, and L. C. Hill, all members of the American Society of Civil Engineers. Mr. Louis C. Hill is the Supervising Engineer in charge of the reclamation projects in Arizona and Lower California, and Mr. C. W. Smith is the Resident Engineer.

The Pathfinder Dam, Wyoming,† is being constructed by the United States Reclamation Service. It will form a storage reservoir for irrigation having a capacity of about 326,700,000,000 gallons. The work is in charge of Mr. Charles E. Wells, Supervising Engineer, and of Mr. E. H. Baldwin, Resident Engineer. The dam is located on the North Platte River, about three miles below the mouth of the Sweetwater River, in a granite canyon

---

\* F. H. Newell was Chief Engineer of the Reclamation Service from its organization to March 9, 1907, when he was appointed Director of this service.

† See Third and Fourth Annual Reports of the Reclamation Service of the United States Geological Survey.

PLATE U.



SHOSHONE CANYON FROM JUST BELOW SITE OF  
DAM.



CANYON ROAD ALONG CLIFF, SHOSHONE PROJECT  
WYOMING

(From Third Annual Report, Reclamation Service, United States Geological Survey.)

Vertical line of text on the left side of the page.

which is 60 feet wide at the bottom, 160 feet wide at the top, and has an extreme height of about 210 feet. Bed-rock is found at the site of the dam at a depth of about 10 feet.

The plan of the dam is curved up-stream, the radius of the centre-line of the top being 150 feet. Owing to the narrowness of the canyon, the dam will doubtless act as a horizontal arch. This action and the stress in the masonry resulting from changes of temperature were both taken into account in designing the profile of the dam (Plate LXXXIX, Fig. 2), which was made considerably thinner than an ordinary gravity section. The theoretical investigations on which the design of the profile was based were made by Edgar T. Wheeler, M. Am. Soc. C. E., under the direction of George Y. Wisner, Consulting Engineer of the Reclamation Service, who has described these investigations in a report of May 1905, made to the then Chief Engineer, F. H. Newell, M. Am. Soc. C. E.\* An independent investigation on this subject was also made by Mr. J. H. Quantin, Supervising Engineer of the Reclamation Service. The dam is being built of broken-range cyclopean rubble.

During the construction of the dam the river is diverted through a rock tunnel, 13 feet wide, 9 feet high at the sides, and 10 feet in the centre. A spillway, 575 feet long, will be constructed on the right bank of the canyon adjoining the dam. On the left bank the dam will be constructed, for about 100 feet at its end, as an earth- and rock-fill.

The contract for the construction of the dam and some auxiliary works was awarded on September 1, 1905, to the Geddes & Seerie Stone Company of Denver, Colorado. The work was begun on September 25, 1905, and by October 30, 1906, 19 per cent of the work covered by the contract was completed.

**The Shoshone Dam, Wyoming,**† is being constructed to form a reservoir of about 148,500,000,000 gallons capacity for irrigation. The work is being done under the direction of the United States Reclamation Service, of which A. P. Davis, M. Am. Soc. C. E., is Chief Engineer. Mr. H. N. Savage is the Supervising Engineer, and Mr. Jeremiah Ahern is Resident Engineer.

The dam is located in a rock canyon of the Shoshone River (Plate U), 70 feet wide at the bottom and 200 feet wide at the crest of the dam, which will be 240 feet above the river-bed and 310 feet above the foundation. The walls of the canyon are of granite.

The surplus flood-water will be discharged by a spillway, 250 feet long, that connects with a tunnel driven through the granite.

Water will be drawn from the reservoir through two conduits, respectively, at 10 and 60 feet above the river-bed. The lower conduit will consist of a tunnel, 10×10 feet in cross-section below the springing lines of the arched roof and about 480 feet long. Its flow will be 10 feet above the bottom of the reservoir. This tunnel will be provided with suitable gates and will discharge the water into the river-channel below the dam. During the construction this tunnel will be used for diverting the river to a point below the site of the dam. The upper conduit will begin with a tunnel 6×7 feet in cross-section, and will deliver water on top of the high bench at the mouth of the Shoshone Canyon, at which point the irrigable land begins.

The dam is founded on solid granite that lies at an average depth of about 65 feet below the river-channel. Its plan is curved, the radius of the centre-line of the curve being 150 feet.

---

\* *Engineering News*, Aug. 13, 1905.

† See Third and Fourth Annual Reports of the Reclamation Service of the United States Geological Survey.

The profile of the dam (Plate LXXXIX, Fig. 1) was designed in the same manner as that of the Pathfinder Dam (see page 207).

The dam is being constructed of concrete in which pieces of granite rock, weighing 25 to 200 pounds, are placed by hand and rammed until well bedded. These rocks are to be well distributed throughout the dam and are to form at least 25 per cent of its volume.

The dam will be provided with a spillway 300 feet long, which will be connected with a tunnel, 20×20 feet in cross-section and about 500 feet long.

The spillway will be constructed on the left bank of the river about 300 feet above the dam and will discharge through the tunnel about 100 feet below the toe of the dam.

The contract for the construction of the dam was awarded on September 18, 1905, to Pendergast & Clarkson of Chicago, the lowest bidders. Up to October 30, 1906, 10 per cent of the work required by the contract had been completed.

**The Cross River Dam** is being constructed on the Cross River, an affluent of the Croton River, about one mile east of the village of Katonah, Westchester County, New York. It will form a storage reservoir of 9,000,000,000 gallons capacity for the water-supply of the City of New York.

The dam will have a length on top of about 772 feet and a maximum height of 170 feet above the foundation. At its southerly end the dam will terminate with an abutment, from which it will be continued by an earthen dam with a masonry core-wall for about 150 feet to the hillside. A circular structure, called the bastion, is to be built at the northerly end of the dam. From the bastion a waste-weir, about 240 feet long, will be constructed along the hillside. The centre-line of the waste-weir will make with the centre-line of the main dam an included angle of  $122^{\circ} 30'$ . A waste-channel will be excavated in rock and will extend from the waste-weir around the main dam to the river-channel below the dam.

Two 48-inch outlet-pipes have been built into the lower part of the dam, north of the river-channel. They are provided with valves and other devices for controlling the flow of the water, which are placed in two suitable gate-chambers, one constructed on the up stream side and the other on the down-stream side of the dam. From the down-stream chamber a reinforced-concrete conduit is to be constructed to a circular fountain basin, from which the water will overflow into the river-channel.

During the construction of the foundations of the dam the river was diverted by a temporary earthen dam, constructed about 200 feet up-stream of the main dam, into a wooden flume, 16 feet wide by  $6\frac{1}{2}$  feet high. This flume was connected at the dam with two 60-inch steel pipes, which were supported, at first, on a steel trestle and built into the masonry as it was carried up. On the down-stream side of the dam a second flume, similar to the one described above, was built from the steel pipes to a second earthen dam, constructed about 325 feet down-stream of the main dam, where the diverted river was turned again into its original channel. The two steel pipes were provided with circular cut-off ribs of steel angles, which were riveted and calked to the outside and inside of each pipe. When the dam has reached such a height that the two 48-inch outlet-pipes can discharge the river through the dam, the two steel pipes are to be filled with concrete, and their ends will be closed by steel dished heads.

The dam is being built according to the profile shown in Plate XC, which was designed to keep the lines of pressure, reservoir full or empty, within the centre-third of the profile, taking into account the pressure due to the water with its surface at the level of the waste-weir, an upward pressure under the base of the dam, due to the water in the reservoir, and

an ice pressure of 24,000 pounds per lineal foot. The upward pressure under the base of the dam was assumed to be, at the up-stream face of the dam, two thirds of the hydrostatic pressure of the water in the reservoir, and to diminish uniformly so as to be 0 at the down-stream face.

The dam is being constructed of cyclopean masonry faced both on the up-stream and down-stream side by blocks of concrete 2 to 3 feet wide, varying in thickness from 36 inches at the bottom to 24 inches at the top. The concrete for these blocks is made of Portland cement, sand, and broken stone, mixed about in the proportions of  $1:2\frac{1}{2}:4\frac{3}{4}$ , in cubical mixers. The concrete for the blocks is placed in wooden forms, provided with steel plates for the faces of the blocks to insure smoothness. The plumb blocks are made with their faces downward and the others with their top beds down, the batter overhanging to obtain density. The mortar used for setting the blocks is mixed  $1:2\frac{1}{2}$ , and that for pointing is mixed  $1:1$ .

The concrete placed in the interior of the dam is mixed about in the proportion of  $1:3:6$ . All mortar for the hearting of the dam is mixed  $1:3$ . According to the average record of the working season of 1906 the cyclopean masonry consists of about 35 per cent rubble, 64 per cent concrete, and 1 per cent mortar. About 0.75 bbl. of cement was used per cubic yard of masonry.

About 87,810 cubic yards of masonry of all kinds have been laid in the dam to January 1, 1907, which amount is about 56 per cent of the total quantity to be laid. The maximum quantity of masonry laid per month was 18,430 cubic yards in October 1906.

The dam and reservoir are being constructed under the direction of the Aqueduct Commissioners of the City of New York. Walter H. Sears, M. Am. Soc. C. E., is Chief Engineer, and George G. Honness, Assoc. M. Am. Soc. C. E., is the Division Engineer in charge of the work.

The contract for the construction of the dam and reservoir was awarded on June 20, 1905, to MacArthur Brothers Company and Winston & Company, at their bid of \$1,246,211.60.

**The Croton Falls Dam** is being constructed on the West Branch of the Croton River, about a mile above the village of Croton Falls, Westchester County, New York, to form a storage reservoir of 14,000,000,000 gallons capacity for the water-supply of the City of New York. This dam is very similar in design to the Cross River Dam described above. It will have a length on top of 1095 feet and will terminate at the north end with an abutment and at the south end with a bastion from which a waste-weir, 700 feet long, is to be constructed, whose centre-line is to form with the centre-line of the main dam an included angle of  $112^{\circ} 35'$ . From the abutment an earthen dam with a masonry core-wall, about 100 feet long, will continue the dam to the hillside. The maximum height of the masonry dam will be about 170 feet above the foundation. Plate XCI shows the profile of the dam.

The dam will have three 48-inch cast-iron outlet-pipes controlled by gates or valves placed in an up-stream and in a down-stream gate-chamber. A diverting dam about 1185 feet long is to be built on the East Branch of the Croton River to turn some of its flood-water through an open channel into the Croton Falls Reservoir. This dam will be an earth embankment with a masonry core-wall. On its easterly side a masonry waste-weir about 1000 feet long is to be built. The dam is being constructed under the direction of the Aqueduct Commissioners of the City of New York. Mr. Walter H. Sears is the Chief Engineer, and Mr. F. S. Cook is in charge of the construction as Division Engineer.

The contract for the construction of the Croton Falls Dam and Reservoir was awarded on August 21, 1906, to James Malloy & Company.

## CHAPTER XIV.

## REINFORCED CONCRETE DAMS.

**Reinforced Concrete Dams.**—In recent years the use of reinforced concrete has spread very rapidly, and in 1904 a beginning was made of building dams of this material. At first it was only used for low structures, as an improvement on wood, but it has been gradually applied to higher structures.

The Ambursen Hydraulic Construction Company of Boston, Massachusetts, has made a specialty of constructing reinforced concrete dams and has built, up to the present time, 22 such structures,\* 10 to 40 feet high and 60 to 1,200 feet long, constructed on foundations of varying character, such as ledge rock, shale, and cemented gravel. This company is about to enter into an agreement to build seven more reinforced concrete dams, 64 to 120 feet high, and is preparing, by special request, plans for a dam of this kind for an extreme height of 315 feet. Some of the types adopted by this company are shown in Figs. 42 to 49.

Fig. 42 shows the simplest construction. Buttresses extending under the whole depth of the dam and increasing in thickness from the top downward, according to the height of the dam, are built 12½ to 15 feet apart, from centre to centre. They are braced laterally by concrete beams, which serve to support the scaffolding during the construction. The maximum load on the piers of the highest dams does not exceed ten tons per square foot. Openings are constructed in the buttresses which make it possible to inspect the lower side of the dam while water is passing over the rollway. If the rock foundation be rough, the buttresses require no anchorage, but in the case of smooth rock, the buttresses are either fastened down by steel dowels or footings are cut in the rock. To prevent leakage under the dam, a heavy cut-off wall may be sunk in the ledge at the heel of the dam, which also affords additional anchorage.

The buttresses support a deck composed of 1:2:4 concrete, mixed very wet with small stone and floated to a close surface. The deck is reinforced by self-locking steel bars † embedded near its lower surface and spanning the buttresses. The thickness of the deck is proportioned to the depth of water it has to support. The crest is heavily reinforced in thickness, and on rivers subject to ice-gorges the extra stiffening of the deck is carried

---

\* Sheldon Springs, Vt.; Wilton and Goffstown, N. H.; Newton, Russell, and Gloucester, Mass.; Woonsocket, R. I.; Theresa, Schuylerville, Horseshoe, Cairo, Gray, Colliers, and Ramapo, N. Y.; Huntingdon and Ricketts, Pa.; Ilchester, Md.; Deltwood, Ill.; (2) Danville, Ky.; Fenelon Falls and Eugenia Falls, Ontario.

† The best bars attainable are used for this purpose, viz.: The "Johnson bar," made by the Expanded Metal and Corrugated Bar Company of St. Louis, Mo.; the "Thatcher bar" and the "Diamond bar," the latter being made by the Concrete Steel Company of New York.



far below the water line. Bulkheads are formed at the ends of the dam by carrying the same deck above the flood and increasing the height of the buttresses correspondingly, as shown in Fig. 42. Steel rods are embedded in the masonry of the dam in various directions to bind the whole structure together.



FIG. 42.—SECTION OF CONCRETE-STEEL DAM FOR MODERATE HEAD AND LEDGE FOUNDATION.

Fig. 43 shows a modification of Fig. 42 in which the deck is carried a certain distance over the crest in order to throw the ice and water far down-stream.



FIG. 43.—SECTION OF CONCRETE-STEEL CURTAIN-DAM.

In Fig. 43 a dam provided with an apron is shown. Vents in the apron just below the crest admit air behind the sheet of water and prevent the forming of a partial vacuum, the cause of trembling dams.

Where the dam can be founded on solid rock, only half an apron is required as shown in Fig. 45. If the foundation is clay or gravel, a broad layer of concrete must first be laid to support the weight of the dam, and either sheet-piling or cut-off walls must be resorted to at the up-stream and down-stream ends of the foundation to prevent leakage



FIG. 44.—SECTION OF CONCRETE-STEEL APRON-DAM FOR CLAY OR GRAVEL FOUNDATION AND HIGH HEAD.

under the dam. Weepers should be provided in the foundation floor to prevent an upward pressure of the water.

The advantages claimed for reinforced concrete dams compared with solid masonry dams are:

1. Stability of twice that of ordinary masonry dams, which increases with the increase of floods;
2. A saving in cost, the materials being distributed to greater advantage;
3. Complete facili-



FIG. 45.—SECTION OF CONCRETE-STEEL HALF-APRON DAM FOR ROCK FOUNDATION AND HIGH HEAD.

ties for internal inspection; 4. Immunity from injury by ice; 5. Adaptability to any ordinary kind of foundation; 6. Elimination of any upward water pressure on the base; 7. Rapidity of construction.

The space made available by the peculiar construction of reinforced concrete dams enables

a special design of power-house to be incorporated in the bulkhead portion of the dam at a great saving of cost. Figs. 46 and 47, which refer to a dam of this kind, 135 feet high, which is about to be constructed in one of the Southern States, illustrate the arrangement of the parts so clearly as to need no special description. The power-house is inserted in the body



FIG. 46.—PROPOSED CONCRETE-STEEL DAM WITH POWER-HOUSE INSIDE OF DAM.

of the bulkhead. Its walls are independent of the deck of the dam, and are made of ferro-inclave and protected on both sides by cement, making a warm and dry structure. A highway bridge can be carried through the upper section of the dam.

With the type of profile adopted for reinforced concrete dams, the resultant of the

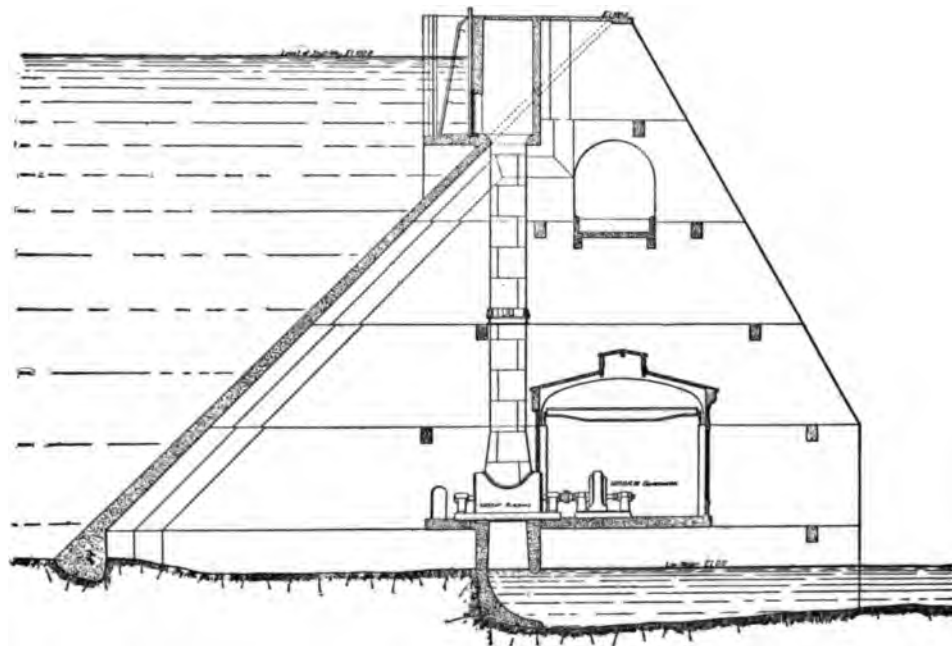


FIG. 47.—CROSS-SECTION OF DAM SHOWN IN FIG. 46.

water pressure and of the weight of the structure falls always near the centre of the base of the dam and overturning is, therefore, impossible. Failure can only occur by sliding, shearing, or crushing under the pressures the different parts of the dam have to sustain. The profile can be designed to keep the resultant pressure of all the forces

acting on the dam always near the centre of the base, securing thus the best distribution of the pressures on the base. Such a profile is shown in Fig. 48, in which the batter of the up-stream face is 1:1, an inclination which may be somewhat varied according to circumstances. The distribution of pressures on the base is shown in this figure, assuming the entire weight to be carried by the buttresses alone, neglecting the weight-carrying capacity of the cut-off wall or heel-block and, also, the counter-action of the water carried on the apron at times of flood. With the profile shown in Fig. 48 it will be found that the resultant pressure of all the forces acting on the dam intersects the base of the dam near its centre for "reservoir empty," moves up-stream until the reservoir is about three-quarters full, never getting outside the centre-third, and then moves down-stream, intersecting the base near its centre for reservoir full and remaining near this point under

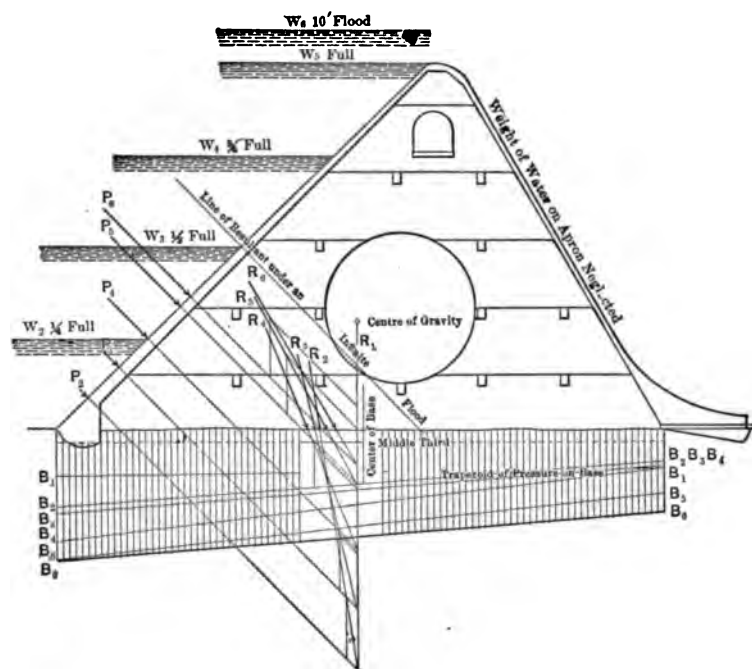


FIG. 48.—PROFILE FOR CONCRETE-STEEL DAM.

the highest floods. We have, therefore, with this profile practically the best distribution of pressures on the base for the time when the dam is most severely tested, viz., during floods.

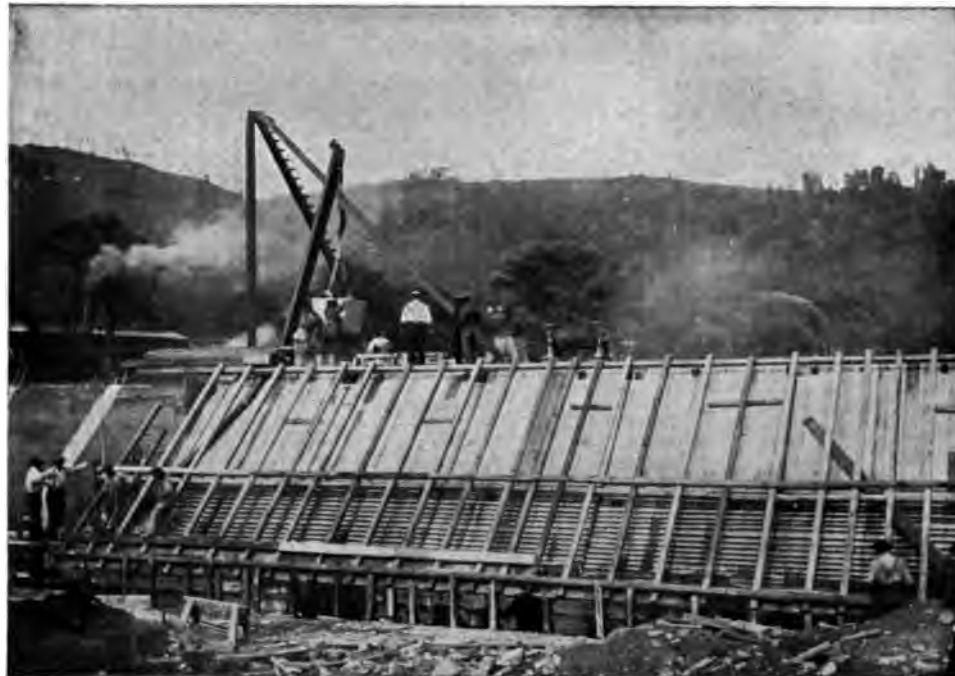
The profile shown in Fig. 48 gives a dam a much broader base than the usual "gravity section" adopted for a solid masonry dam. With the former profile the factor of safety against overturning is never less than 6, while with the latter it varies usually in different parts of the structure from 2 to 3.

Wooden dams are often destroyed by the expansion of ice and by ice-gorges acted on by floods. The relatively soft material of the deck planking gives the ice a chance to bite deeply into it and to tear it from its purlins. The reinforced-concrete dam offers a hard surface to the ice and an easy incline for passing it over the crest of the dam. Solid masonry dams usually have their up-stream faces vertical for a certain depth. On this account some engineers deem it advisable to take into account an ice pressure amounting to as much as 30,000 pounds per lineal foot as acting against a masonry dam. The inclined up-stream face of a reinforced-concrete dam makes such an action impossible.

PLATE V.



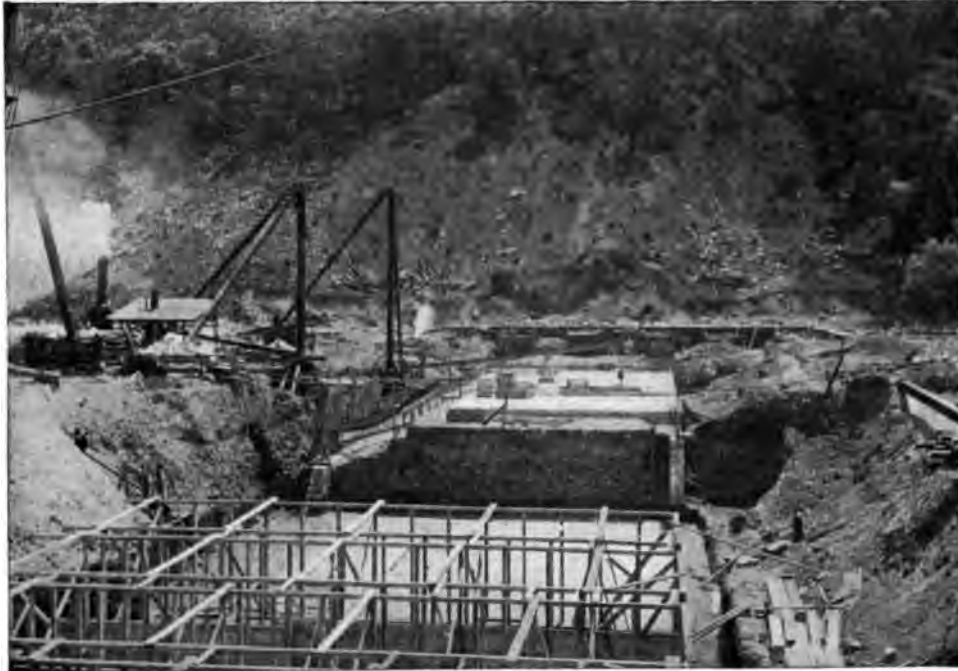
JUNIATA DAM. SHOWING CONSTRUCTION OF BUTTRESSES AND DECK.



JUNIATA DAM. CONSTRUCTING DECK OF REINFORCED CONCRETE.

Vertical line of text or a scanning artifact on the left side of the page.

PLATE W.



JUNIATA DAM. SHOWING WHEEL-PIT, SECTION OF GRAVEL FOUNDATION, CUT-OFF WALLS, AND PORTION OF FLOOR.



JUNIATA DAM. FLOOR NEARLY COMPLETED.





The Dam at Schuylerville, New York,\* was constructed in 1904, for the American Wood Board Company, on the Batten Kil River. The dam was built of reinforced concrete and was made hollow, but the abutments, wing-walls, and bulkheads were built of solid concrete. The dam has a length of rollway of 250 feet between abutments an average height of 25 feet above the river-bed, and a maximum height of 28 feet.

The strains in the dam were calculated for an assumed flood of 5 feet on the rollway. Fig. 49 shows the cross-section of the dam. The dam is founded on Hudson River shale. A trench, 5 feet wide and 3 feet deep, was excavated for the cut-off wall at the upper heel of the dam. No excavation was made for the buttresses or toe, the rock being only washed by a jet of water under pressure to prepare it as a foundation. The passageway in the interior of the dam forms the only means of communication between the mill on

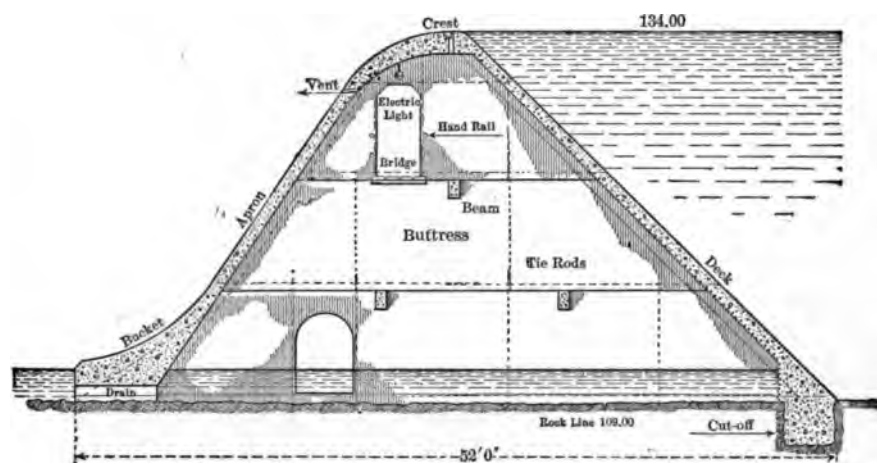


FIG. 49.—SCHUYLERVILLE DAM.

the north bank and the railroad station on the south bank of the river, and is in daily use. It is dry and well ventilated by the air coming through the vents in the apron.

The hydraulic works of the American Wood Board Company were designed by Mr. George F. Hardy of New York; Tucker and Vinton of New York were the general contractors for the dam. The plans for the dam were prepared by the Ambursen Hydraulic Construction Company of Boston, which took a sub-contract for the elaborate false-work and moulds for the dam. The construction was begun on September 27, 1904, and was completed by the following December 31st.

**The Juniata Dam**† (Plates V and W) was constructed in 1906 on the Juniata River, at a gap in Warriors Ridge Range, about four miles west of Huntingdon, Pennsylvania. The drainage area supplying the river above this gap contains about 900 square miles.

The dam extends across the river in a nearly north and south direction. Its south end abuts against the foot of Warriors Ridge and the north end against the power-house. The dam has a rollway 375 feet long, having a maximum height of  $27\frac{1}{2}$  feet. The buttresses of the dam are 10 feet, centre to centre. They are 18 inches thick at the bottom and 14 inches thick at the top, the reduction being made by a 2-inch offset at each side. Two rectangular openings are provided in each buttress. A plank walk carried through

\* *Engineering Record*, March 4, 1905. •

† *Ibid.*, December 22, 1906.

the upper openings serves as a passageway for inspection of the inner surface of the dam, but the lower openings were only made for convenience during the construction.

The river-bed at the site of the dam consists of clayey gravel, underlain by a soft black slaty material. A cut-off wall, both at the up-stream and down-stream toe of the dam, extends down to this slate, but the floor rests on the natural bed of gravel and is provided with weep-holes to relieve any upward hydraulic pressure. A drain-pipe through the concrete below the down-stream toe carries off the seepage-water. The width of the dam from outside to outside of the cut-off walls is  $57\frac{1}{2}$  feet. A floor of boulder concrete is placed on the down-stream side of the dam to prevent scouring during floods. At the south end of the dam the two sections nearest the abutment are raised 10 feet higher than the crest of the rollway to form a buttress. The abutment wall is founded on slate and is joined by the two cut-off walls. The ends of the abutment turn into the bank at an angle of about  $45^\circ$  with the direction of the flow and are extended far enough to prevent leakage around the dam. No buttress is provided at the power-house end of the dam.

The dam and power works were built by the Juniata Hydro-Electric Company. The plans for the dam were prepared by the Ambursen Hydraulic Construction Company of Boston, Massachusetts, which also furnished the construction plant and a skilled superintendent.

**The Upper Otay Dam, California,\*** is an unusually frail masonry dam, which owes its stability to the curving of the plan and to the reinforcing of the upper part of the dam by steel plates and railway cables. It was constructed in a narrow porphyry rock gorge on the west fork of the Otay Creek, which is only 20 feet wide at the creek.

The dam is 4 feet wide on top and 14 feet wide at the base, its maximum height above bed-rock being 84 feet. The plan is curved to a radius of 359 feet and its length on the crest is 350 feet. The dam was built of the best Portland-cement concrete. For the first 34 feet of its height the structure was built as an ordinary masonry dam, but above this level the dam was reinforced by two tiers of steel plate, set longitudinally in the concrete on the axis of the dam, above which  $1\frac{1}{4}$ -inch railway cables were placed vertically in the concrete, at intervals of 2 feet, reaching within 5 feet of the crest of the dam.

The reservoir formed by the dam has a capacity of 650,000,000 gallons, but a watershed of only 8 square miles, which is insufficient to fill the reservoir. For several years after its completion, which took place in the fall of 1900, the reservoir was not filled and the dam was, therefore, not subjected to the full water pressure it was designed to resist. The intention was to fill the reservoir from another storage basin at a higher level, by means of a conduit, but the author is not informed whether this has been done.

The design of the dam has been attributed to Mr. E. S. Babcock, President of the Southern California Water Company, for which the reservoir was built. Mr. C. M. Bose was the engineer in charge of the construction of the dam and reservoir. Considering its height, the dam is one of the boldest structures of its kind.

---

\* "Irrigation Engineering," by H. M. Wilson, M. Am. Soc. C. E.; "Reservoirs for Irrigation, Water Power, and Domestic Water-supply," by James D. Schuyler, M. Am. Soc. C. E.; and *Engineering News*, April 7, 1904.

## PART II.

---

### CHAPTER I.

#### EARTHEN DAMS.

AT a very early period of history the construction of earthen dams to impound water was begun. Many reservoirs constructed in this manner in India, ages ago, are still in use. They are called "tanks." One of them—the Veranum Tank—which covers 35 square miles, is formed by an earthen dam 12 miles long. The Poniary Tank, which is no longer in use, had a water area of 60 to 80 square miles. Its dam had a length of about 30 miles.\*

These old dams, which have withstood so successfully the ravages of time, were constructed in a very primitive manner. They are simply large mounds of argillaceous earth which was brought in baskets to the site of the dam and was compacted by the tread of the army of workmen engaged on the work. Their profiles are much larger than those adopted for modern dams.

By the experience of centuries and the lessons taught by many catastrophes the proper dimensions of earthen dams and the precautions that should be observed in their construction have been fully established. The design of such works should not be based upon mathematical calculations of equilibrium and safe pressure, as in the case of masonry dams, but upon results found by experience. Most of the earth dams constructed within the last century have had a large margin of safety in resisting the water-pressure, both as regards overturning and sliding, and yet frightful distasters, such as the rupture of the Dale Dyke and the Johnstown dams (see page 246), have resulted from faults in designing some details or from neglect in the construction of the work.

**General Plans.**—An earthen dam may consist of—

1. A homogeneous bank of earth.
2. A bank of earth having a puddle-core (Plate XCIII.).
3. A bank of earth having a masonry core-wall (Plate XCIV.)
4. A bank of earth having puddle placed on the water slope.

The first method of construction can only be safely used when a sufficient quantity of earth or gravel containing enough clay to make the dam water-tight can be obtained at a reasonable cost.

---

\* See "The Designing and Construction of Storage Reservoirs," by Arthur Jacob, B.A.

Where it would prove too expensive to form the whole dam of such binding, water-tight material, only a central core is formed of clayey earth or gravel, ordinary earth being used for the other portions of the dam. In this case the whole water-tightness of the dam depends on the core, which is formed of "puddle material," viz., clay, earth, and sometimes gravel, which are thoroughly mixed and compacted. Even when good material is available for the dam, puddle should be placed below the surface in a trench excavated to an impervious stratum, in order to prevent leakage under the dam.

The third plan consists in substituting a masonry "core-wall" for the "puddle-core." This plan will have to be adopted when no clayey earth can be obtained at a reasonable cost. It will generally be found more expensive than plans 1 or 2, but, on the other hand, has great advantages as regards safety. For small or temporary dams the core is occasionally made of planks driven as sheet-piling.

The puddle is sometimes placed on the inner slope with a view of preventing the water from percolating into the dam, but this plan is open to two objections: 1st. The puddle is apt to be injured by the settling of the slope, which is sure to occur to a greater or less extent; 2d. Cracks will appear in the puddle when it is exposed to alternate wetting and drying due to fluctuation in the level of the water.

It is important to prevent the water from percolating to the centre of the dam, but any water that may reach there should be drained off so as not to saturate the outer slope. This may be accomplished, when there is a difference in the quality of the earth put in a dam, by placing the most water-tight material in the inner slope, while the more pervious kinds (gravel, etc.) are deposited in the outer slope. Drain-pipes are occasionally laid at the outer side of the puddle-core to carry off any water that may percolate through the puddle.

In some dams selected water-tight earth is placed on both sides of the puddle-core, the remaining parts of the embankment being made of more pervious material.

**Materials.**—The best material for forming an earthen dam is an earth, a gravel, or a hard-pan containing just enough clay to give it the required water-tightness and binding quality. Clay alone or in a large proportion will not answer the required purposes, as it swells when wetted and shrinks in drying. This quality makes it very dangerous in any part of a dam where it may be alternately wet and dry. Gravel will tend to fill up a hole that may be formed in a dam, but clay is apt to arch over an opening, which may be enlarged and lead to the rupture of the structure. Many failures have been caused by using too much clay in the body of the dam. Some authorities recommend the use of 20 to 30 per cent of clay for the body of the dam or in the puddle-wall, but a much smaller quantity—5 to 20 per cent—will often be found to be sufficient. No general rule can be laid down, as the percentage of clay depends upon the nature of the materials with which it is mixed.

**The Profiles** of earthen dams are determined entirely by practical considerations. The general dimensions of the profile depend upon the materials used and the height of the bank, additional strength being given to high dams. The dimensions usually adopted are as follows:

## PROFILES FOR EARTHEN DAMS.

Top-width, . . . . .	10 to 30 feet.
Superelevation above high water, . . . . .	5 to 25 feet.
Inner (up-stream) slope, . . . . .	2:1 to 3:1.
Outer (down-stream) slope, . . . . .	1½:1 to 2½:1.

The top-width should be at least 10 feet. If the top of the dam is to serve as a road across the valley, it may require a width of 20 to 30 feet, but the latter figure need rarely be exceeded. The top of the dam should be sufficiently raised above the highest water-level to be beyond the reach of the highest waves in the reservoir. The height of the waves depends upon the extent and depth of the reservoir and upon its exposure to winds. Where violent winds occur waves may be dashed against a dam to a height of 10 to 15 feet.

Ordinary earth will stand on a natural slope of 1½ to 1. The outer slope of the dam may be given this inclination, but it is usually made a little flatter, viz., 2 to 1 and even 2½ to 1. In dams of considerable height (60 to 100 feet) the outer slope is often broken by one or more berms, placed about 30 feet apart vertically, in order to increase the cross-section and base of the dam and to prevent any washing of the long outer slope by heavy rain-storms. The berms should be provided with paved gutters which lead the rain-water to the hillsides of the valley (Fig. 1, Plate XCIV.).

Earth saturated with water assumes a much flatter slope than when dry. For this reason the inner slope of the dam is made flatter than the outer one, viz., 2½ to 1 or 3 to 1. The latter slope is usually adopted by English engineers.

The inner slope is protected against the action of the water and against vermin by a paving of rectangular stones having a thickness of 15 to 24 inches, according to the height and importance of the dam. This paving should be placed on a 12- to 18-inch layer of broken stones (about 2 to 3 inches in diameter), and should be carried up 5 to 15 feet above the high-water level, as the height of the waves may require.

The top of the dam, the outer slope, and the inner slope above the paving are covered with good soil and sodded.

**The Puddle-core**, required when Plan No. 2 is adopted, should be made of the best materials that can be obtained at a reasonable expense. Gravel, sand, clay, and occasionally peat have been used for this purpose. A clayey gravel or hard-pan is the best material that can be used. Sometimes additional clay will have to be added to the gravel or hard-pan, but the percentage of clay in the whole mass should not exceed the figures mentioned on page 222. Clay should never be used alone for the puddle-core, as it gets slimy and sticky when wet and cannot be spread uniformly. In drying it shrinks and cracks and may still retain water. The clay should be free of sand and soft stones. The materials used in the puddle-core should be uniformly mixed, sufficiently moistened and worked ("tempered") to make a tough, elastic mass which should be carefully deposited in layers. If the work is interrupted the puddle should be covered with boards or earth to prevent it from cracking by drying too rapidly.

The thickness of the puddle-core depends upon the kind of material of which it is composed, and upon the "head" of the water to be resisted. Considerable variation occurs in cross-sections adopted by different engineers for these walls. The puddle-core should be 4 to 8 feet thick at the highest water-level. Both faces should be battered uniformly so that the thickness of the wall at the natural surface shall be one third of the head of the water to be resisted. From the natural surface to the bottom of the foundation-trench the thickness of the puddle-core is either made uniform or gradually diminished, but never over 50 per cent; i.e., the thickness at the bottom of the trench should be at least one half the thickness at the natural surface. This reduction of the thickness of that portion of the puddle-wall which lies below the surface of the ground is really contrary to theoretical requirements. It is due to the practical difficulties encountered in trying to excavate a deep trench with vertical sides. Offsets in the sheeting are almost sure to occur. This would ordinarily necessitate starting the foundation-trench with a great width, involving much expense, if the puddle-core were required to have the same thickness from top to bottom of the foundation-trench.

The puddle-core must be founded on an impervious stratum (rock, hard-pan, clay, etc.) which will make it impossible for the water to percolate under it. To reach such a stratum the foundation-trench will often have to be excavated to a great depth. A covering of at least 3 to 4 feet of ordinary earth must be placed on top of the puddle-core to protect it against frost. This object is accomplished on the sides by the slopes.

Mr. J. T. Fanning,\* M. Am. Soc. C. E., has used for some dams a very superior kind of puddle composed of coarse gravel, fine gravel, sand, and clay. The voids of the coarse gravel are filled with fine gravel, the voids of the resulting mixture are filled with sand, and enough clay is added to give the mixture sufficient binding quality. This puddle is nearly free of voids. It weighs almost as much as granite and resists not only the action of water, but also the attacks of rats, eels, and other vermin.

The following table gives the theoretical proportions required for this puddle and those used by Mr. Fanning in practice:

PUDDLE OF GRAVEL, SAND, AND CLAY.

MATERIALS.	Percentage of Voids.	CUBIC YARDS REQUIRED.	
		Theoretically.	Practically.
Screened coarse gravel.....	28-30	1.00	1.00
Fine gravel.....	30	0.28	0.35
Sand.....	33	0.08	0.15
Clay.....	....	0.03	0.20
Total of materials.....	....	1.39	1.70
Resulting puddle.....	....	1.00	1.30

\* Treatise on Water-supply Engineering, by J. T. Fanning. New York, 1882.

Fanning describes the manner in which he formed such a puddle-core for a dam as follows:

"When measured by cart-loads, the quantities became eight loads\* of mixed gravels, one load of sand, and two loads of clay, the cubic measure of each load of clay being slightly less than that of the dry materials. The gravel was spread in layers of 2 inches thickness, loose, the clay evenly spread upon the gravel and lumps broken, and the sand spread upon the clay. When the triple layer was spread, a harrow was passed over it until it was thoroughly mixed, and then it was thoroughly rolled with a 2-ton grooved roller, made up in sections, the layer having been first moistened to just that consistency that would cause it to knead like dough under the roller, and become a compact solid mass.

"The proportions adopted for the core were a thickness of 5 feet at the top at a level 3 feet above high-water mark, and approximate slopes of 1 to 1 on each side."

The puddle described by Mr. Fanning is certainly excellent, but, considering the amount of work and care required in mixing it, we doubt whether it is in ordinary cases much cheaper than concrete or rubble masonry.

**Masonry Core-walls** are doubtless the best means of insuring water-tightness in an earthen dam, and should generally be adopted when the means at disposal will permit their use. They can be constructed of concrete or of rubble masonry. The up-stream face should be well plastered with cement mortar.

These walls are not designed to resist the whole water-pressure in the reservoir, as they are simply to act as cut-off walls that will stop any water which may have percolated through the inner slope. Theoretically we would conclude that if any water reaches the core-wall, a section of it might eventually have to resist the whole hydrostatic pressure from the reservoir. As the wall is only backed by earth, we would imagine that the light core-walls adopted in practice might fail, but experience does not prove this to be the case. Tests made by sinking holes along the inner face of core-walls will generally show that water, having a few feet less head than that due to the reservoir, reaches the wall. Nevertheless these walls stand, and we must, therefore, conclude either that they are never subjected to any extent to the full pressure due to the reservoir, or else that the well-rolled earth with which they are backed enables them to resist the pressure.

Core-walls for high dams are usually given a stronger section than those for lower ones. The top of the wall, which should be placed at high-water level, is made  $2\frac{1}{2}$  to 6 feet wide. Both faces are battered uniformly from the top to the surface of the ground and are then vertical to the foundation, which must be laid on an impervious stratum. The thickness of the core-wall at the natural surface should be about  $\frac{1}{4}$  to  $\frac{1}{2}$  of the "head" in the reservoir. Instead of battering the faces the increase in thickness may be made by offsets, about 10 feet apart.

**A Waste-weir (Overflow-weir, Spillway)** to discharge the water which rises above the high-water level must be provided for every reservoir. Its crest is placed 5 to 25 feet below the top of the dam, according to the superelevation given the latter.

---

\* Seven loads of coarse and three loads of fine gravel make, when mixed, about eight loads in bulk.

The waste-weir usually forms part of the main dam, but occasionally the flood-water may be discharged into a lateral valley by excavating a low ridge or by building the waste-weir as an auxiliary dam at some depression lying below the high-water mark. When the material excavated to form a waste-weir consists of rock, it is levelled at the proper height with concrete or rubble. If the excavation is in earth, a suitable overflow-wall must be built.

In the case of a reservoir supplied by a small watershed the waste water may be carried off by means of a well located in the reservoir, usually constructed in the gate-house controlling the outlet.

When the waste-weir forms part of the main dam it is placed near the centre of the valley, if both side hills are of earth. If either of them consists of rock at or near the surface, the waste-weir is formed at the rocky side of the valley by excavating the rock or building a low wall on it, as its elevation may require.

The determination of the proper length of a waste-weir is a very important matter.\* Many a dam has failed because its waste-weir could not discharge an unusual flood. The amount of water which a weir of a certain length will discharge with a given depth of water can be calculated by the following formulæ given by Mr. J. B. Francis for depths of 9 to 36 inches:

For wide-crested weirs

$$Q = 3.012lH^{1.85}.$$

For flashboards with square edges

$$Q = 3.33(l - 0.1nH)H^{\frac{3}{2}};$$

in which  $Q$  = discharge in cubic feet per second;

$l$  = length of the weir in feet;

$H$  = depth of water above the crest, in feet, measured above the weir;

$n$  = number of end-contractions.

No general rule can be given for estimating the maximum amount of flood-water that may reach a reservoir from a given watershed. This quantity will depend upon the rainfall, and the character and extent of the watershed. The larger the watershed, the longer will be the period required for the water flowing off, after a certain rainfall, to reach the reservoir.

An empirical English rule for watersheds of less than 3 square miles area is to allow 1 lineal yard of waste-weir for every 100 acres in the watershed. For watersheds having areas of 1 to 50 square miles E. Sherman Gould, M. Am. Soc. C. E., recommends in his book on "High Masonry Dams" an allowance of 1 lineal yard of overflow-weir per square mile of watershed. He suggests, also, the following empirical formula:

$$\text{Length of overflow in feet} = 20 \sqrt{\text{number of square miles in watershed.}}$$

Whenever it is possible, the engineer should collect data as regards the maximum amount of flood-water likely to reach a reservoir. The greatest recorded depth of



water in the river at some bridge or culvert above the reservoir may furnish valuable information in this connection.

In calculating the length of the waste-weir, the depth of the sheet of water passing over the weir in the worst recorded flood is usually assumed as 1 to 3 feet. As the top of the dam is generally 5 to 15 feet above the crest of the overflow-weir, the flood-water may rise considerably above the assumed highest level without endangering the safety of the dam.

To increase the capacity of a reservoir, the height of a waste-weir is sometimes temporarily raised by means of planks (known as "stop-planks" or "flashboards") placed in grooves in iron standards, or masonry piers built on top of the weir, or by forming a small earthen bank on top of the weir. In the latter case no danger could arise from an unexpected freshet, as the temporary earthen bank would be washed from the top of the overflow-weir. In the former case, the stop-planks must be removed either by hand or by some automatic contrivance, during floods. There is, however, always the danger of the planks not being removed in time.

A suitable channel must be constructed for conveying the waste water of the reservoir from the overflow-weir to some point below the dam where it can be turned into the stream. It is important that this channel should have sufficient capacity to discharge easily the maximum amount of water that may flow over the waste-weir.

A **By-wash** is often provided for reservoirs supplied by streams liable to carry much suspended matter at times. Its object is to lead the stream during floods around the reservoir, discharging the muddy water either into the stream below the reservoir or into compensating reservoirs in which the quality of the water is of no importance. These basins serve during droughts to feed the stream below the reservoir.

The discharge of the stream into the service or the compensating reservoir may be regulated by sluice-gates. Automatic means are sometimes provided for this object. An ingenious arrangement for accomplishing this purpose, known as separating-weirs (Fig. 50), was first introduced in the water-works of Manchester, England. During

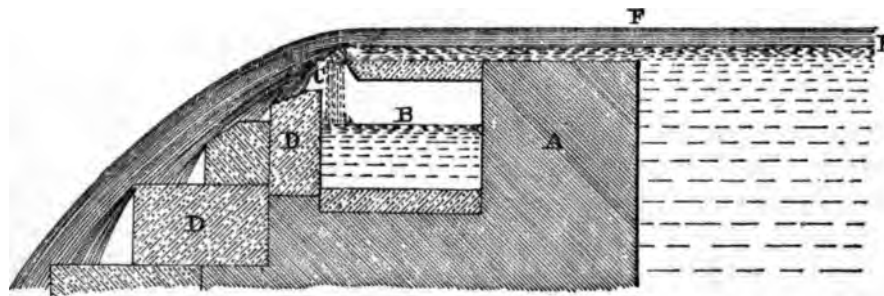


FIG. 50.—SEPARATING WEIR.

floods the water from the gathering-ground is carried, owing to its greater velocity, over an opening of a well into which it falls when its velocity is reduced. The water passing over the opening is led to the by-wash, while that falling into the opening flows to the reservoir. Mechanical means are also sometimes employed for separating the flood from the clear water.

**Outlet- and Waste-pipes.**—A reservoir is usually provided with two outlet-pipes for conveying the water from the reservoir either directly to the place of consumption or to some stream flowing into a lower storage basin. These pipes are arranged so that one line can be in service while the other is undergoing repairs. A scouring- or waste-pipe is also required for emptying the reservoir for repairs and for "blowing out" deposits of silt, etc. The latter object is accomplished by simply opening the pipe, when the rush and pressure of the water will force out ("blow out") the deposit. The waste-pipe should be located at the lowest part of the reservoir in order to be able to drain it completely. Sluice-gates and stop-cocks for controlling the outlet- and scour-pipes are placed in the gate-house and stop-cock vault described on page 230.

One of the most important details connected with the construction of a reservoir is the manner in which the pipes mentioned above are laid through or around the dam. Formerly it was quite customary to lay these pipes right in the dam, without any protection, the earth being simply packed tightly around them. Numerous failures have proved the danger of this method of construction. The outlet-pipes were frequently cracked by a settling in the dam. The water under pressure which found its way thus into the embankment usually flowed along the smooth outer surfaces of the pipes, washing out a channel which led to the rupture of the dam unless the damage was detected and repaired in time.

The danger of the escaping water flowing along the outside of the pipes can be prevented, to a certain extent, by building at intervals "cut-off walls" around the pipes. They should project at least 2 feet all around the pipes, to which they must be closely fitted. Three or more cut-off walls are usually built.

If flanged pipes are used instead of those of the hub-and-spigot pattern, the flanges will act as cut-offs, impeding the flow of the escaping water. This object may be accomplished in a better though more expensive manner by surrounding the outlet-pipe with a ring of brick masonry.

The only safe method of carrying the outlet-pipes through a dam having a puddle-core is to lay them for their whole length through the dam on a masonry wall built on an unyielding foundation. Masonry piers will not answer the purpose, as a settling may occur between them.

Instead of laying the outlet- and blow-off pipes directly in the dam, they may be placed in a masonry culvert passing through the dam. By this arrangement the pipes are relieved of the pressure due to the weight of the earthen bank, which is borne by the masonry. They can, also, be inspected and repaired. The culvert is usually made circular, but if its section is large it is preferable to make it elliptical, the ratio of the horizontal to the vertical diameter being about as 2 to 3. Sometimes a "horseshoe" section is adopted, as its flat invert gives more space than circular or elliptical sections for placing and repairing the pipes.

As the scouring-pipe should start from the lowest point in the reservoir, the culvert is usually built in excavation. Where it crosses the puddle-trench (which has generally considerable depth) the culvert should be supported by a masonry wall built on an unyielding foundation. As a settling may take place on either side of this

wall it is best to provide the culvert at these points with loose, vertical slip-joints which will permit a settling without the masonry being ruptured.

At its down-stream end the culvert is terminated by arches, strongly buttressed to withstand the pressure of the outer slope and provided with wing-walls. The up-stream end of the culvert is usually joined to the gate-house or water-tower containing the sluices for regulating the flow from the reservoir.

In order to reduce the height of the masonry wall in the puddle-trench, the culvert is usually built descending to this trench and rising from it down-stream. Sometimes, however, the culvert has vertical changes of grade.

Although the outlet-pipes can be safely laid through an earthen dam if the proper precautions are observed, it is best to lay these pipes in a lateral tunnel passing through a hill at either side of the dam whenever this method is not found to be too expensive. The tunnel must be closed at the reservoir by a masonry bulkhead (wall) through which the pipes pass. It should be lined with masonry and left open at its down-stream end so as to permit inspection and repairs of the pipes. During the construction of the dam this tunnel may serve—if large enough—as a temporary channel for the stream.

When an earthen dam is provided with a masonry core-wall, the outlet- and scour-pipes can be safely laid through the dam without being supported by masonry, as the core-wall forms a perfect cut-off which prevents any water from reaching the outer slope of the dam. In this case the water may be safely conveyed through the inner slope in a masonry conduit. Iron pipes laid in a culvert, permitting inspection and repairs, carry the water through the outer slope. The pipes are connected with the masonry conduit by iron reducers\* which are built in the core-wall. With this arrangement a settling of the earth either in the inner or outer slope cannot produce any disaster.

Instead of the masonry conduit mentioned above, iron pipes may also be used to convey the water to and through the core-wall. In order to facilitate repairs it is advisable to lay these pipes in a culvert, as in the outer slope. The culvert should be so connected with the inlet gate-house or water-tower that the pipes can be inspected even when the reservoir is full.

The outlet-pipes of low dams are sometimes laid as siphons over the top of the bank. This is the safest arrangement that can be adopted, but the pipes will have to be protected against frost in a cold climate, and a pump will have to be provided to start the siphon when it is stopped by air accumulating at its highest point.

**Gate-house (Water-tower, Valve-tower).**—The outlet from a reservoir is usually controlled by sluice-gates, valves, or stop-planks placed in a gate-house or valve-tower. For a dam having a masonry core-wall the gate-house is generally constructed at the up-stream face of this wall. If the dam consists entirely of earth, the gate-house is placed in the reservoir near the toe of the inner slope, access to it being obtained by means of a foot-bridge.

---

\* Iron pipes whose area is gradually reduced. The largest section, at the masonry conduit, is generally made rectangular. This shape is gradually changed to the circular section of the outlet-pipes. The reducers serve to lessen the loss of head at the inlet.

The gate-house may be a very simple structure or one of importance according to circumstances. Fig. 51 shows the plan of a very simple outlet of masonry which contains simply a double set of grooves in the masonry side walls for stop-planks, and has no sluice-gates. The water is ordinarily controlled by stop-cocks placed in a vault at the outer slope, two sets being provided, one placed behind the other. When it becomes necessary to shut off the water at the gate-house, the stop-planks are dropped in the grooves. By tacking a piece of marlin\* on the bottom side of each stop-plank quite a tight bulkhead will be formed. Any leaks that may exist can be stopped by calking, and if necessary clay can be dropped between the two sets of stop-planks, but this will rarely be required.

A more complicated gate-house, which may be used for an earth or masonry dam, is shown in Plates LXX. and LXXIII. It consists of a masonry substructure, containing the water-chambers, sluice-gates, etc., and of a superstructure, constructed usually of masonry, which protects the hoisting machinery of the sluice-gates. The substructure is divided by a central wall into two divisions, one for each line of outlet-pipes. A cross-wall divides each division into an inlet- and an outlet-chamber. Each inlet-chamber has three openings at the reservoir for drawing water at different levels, one at the surface † of the reservoir, one at mid-depth, and the third near the bottom. These openings are provided with screens (made of bar iron or fine wire netting, as circumstances may require) and can be closed by stop-planks. One or more openings controlled by sluice-gates are constructed in the cross-walls between each set of chambers. In the back wall of the outlet-chambers the reducers for the outlet-pipes are placed. When a gate-house of this kind is built at the core-wall of an earthen dam, either the inlet-pipes must be laid through the inner slope of the dam to the reservoir, or else the inner slope must be omitted at the gate-house, and wing-walls must be built to retain it on both sides.

Instead of a gate-house of the kind just described, a circular valve-tower is sometimes constructed to regulate the outflow from the reservoir. If the water has but little depth, this tower may consist of a vertical cast-iron pipe, having inlet openings at different levels, and connections, at the bottom, with the outlet-pipes. If the depth of the water in the reservoir is considerable, the valve-tower should be constructed of masonry. The inlet openings may consist of short lengths of pipe embedded in the masonry and controlled by stop-cocks, sluice-gates, flap-valves, or poppet-valves operated from the top of the tower. Plate XCII. shows such a tower.

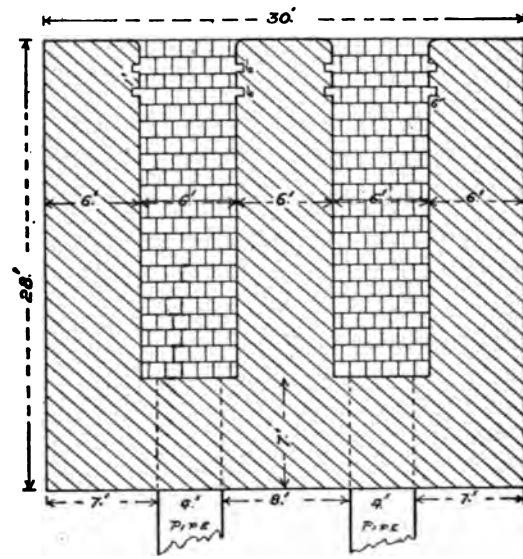


FIG. 51.—OUTLET FROM RESERVOIR.

\* A small tarred cord of two strands used for winding around ropes and cables.

† The best water in a reservoir is usually a few feet below the surface.

Another arrangement consists in confining the water in a vertical stand-pipe, which is placed in the valve-tower. Short horizontal pipes, placed about 10 feet apart vertically, form the inlet openings and are connected with the stand-pipe. Each inlet-pipe is controlled by a bronze flap-valve, placed just outside the tower, and, also, by a stop-cock or sluice-gate inside of the tower. With this arrangement, the gate-keeper can enter the culvert for the outlet-pipes at the outer slope of the dam and pass into the valve-tower, inspecting the whole outlet-pipe system.

**Stop-cock Vault.**—In addition to the arrangements for controlling the flow into the outlet-pipes, one or two sets of stop-cocks are often provided for each line of outlet-pipe. These stop-cocks are placed in a vault constructed near the toe of the outer slope of the dam (Plate LXXIII.). The down-stream set of stop-cocks are generally used. If one of them should get out of order, the up-stream stop-cock of its line would serve to control the flow. The scour-pipe usually passes through this vault, where it is also controlled by a stop-cock.

**Outlet Fountain.**—When the outlet-pipes discharge into a stream the water is sometimes aerated by being thrown upwards in vertical jets in a fountain. If the pipes are of small diameter, their ends may simply be terminated by elbows which make them discharge vertically. In the case of large outlet-pipes, several smaller jets are substituted by pipe-connections for one large one. The basin of the fountain must have a sufficient capacity to contain the outflow from the jets without overflowing. At the point where the water flows from the basin, a weir may be constructed for measuring the water drawn from the reservoir.

**Construction.**—In selecting a site for a dam, careful investigations of the ground on the proposed location must be made by means of test-borings and pits. The core-wall or puddle-core of the dam must be founded on an impervious stratum (solid rock, hard-pan, clay, etc.). It is important to find a site for the dam where an impervious stratum can be reached at a reasonable expense. This stratum must have sufficient depth to be able to support the weight of the dam. Occasionally a thin stratum of impervious hard-pan or clay overlies very pervious material. The test-borings must, therefore, be carried to a sufficient depth to give a clear indication of the ground upon which the dam is to be founded.

Having selected a suitable location for the dam, the first step in beginning the construction is to remove the surface soil from the whole space that is to be covered by the dam. This material is deposited in temporary mounds known as "spoil-banks" and reserved to cover those surfaces of the finished dam that are to be sodded. If the impervious stratum be near the surface, it will be advisable to remove all the material overlying it within the dimensions of the dam. Should this involve too much expense, only a trench for the core-wall or puddle-core need be excavated to the impervious stratum. To attain the desired object, this trench may have to be excavated to a great depth.

Springs are frequently encountered in making the excavations for a dam, especially in the puddle-trench. Whenever possible, they should be stopped by means of hydraulic mortar or masonry. If this cannot be done, the springs should be led in pipes beyond

the toe of the dam, or they may be confined in vertical pipes which are finally closed by filling them with grout or clay.

If the core of the dam is to consist of masonry, it should be constructed either of concrete or rubble, laid in hydraulic cement mortar and made as water-tight as possible, its up-stream face being plastered with mortar. Tests made on earthen dams constructed for the water-works of New York (see page 243) show that even when a core-wall has been well built some water is apt to find its way into the outer slope of the embankment, when the reservoir is full, either through cracks in the core-wall or through fissures in the rock foundation. This may also occur with a puddle-core. It is, therefore, advisable to construct a permanent drainage system under the outer slope of an earthen dam in order to get rid of all seepage-water.

The foundation of the core-wall may change from rock to impervious earth (hard-pan, etc.). If the wall has considerable height, it is apt to crack at the points where the foundation changes, owing to differences in settling. In such a case it is advisable to construct wells in the core-wall at the points of the above changes, which will permit an inspection and repairs of the wall if required. The wells may be filled at first with gravel and finally with masonry. A well of this kind was constructed in the core-wall of the Titicus Dam, described on page 146.

The general manner of forming a puddle-core has already been explained. In excavating the puddle-trench it is generally stepped where sudden changes of grade occur. If the steps have considerable height, they may cause cracks in the puddle-core on account of differences in settling. In such cases it is better to use inclines instead of steps, as this arrangement tends to consolidate the puddle towards the centre of the valley.

A core-wall may be carried up independently of the rest of the dam, but a puddle-core should be brought up simultaneously with the other portions of the dam.

The dam should be constructed in layers which are either horizontal or incline slightly towards the central core-wall or puddle-core. Some engineers make the layers 2 to 3 feet high, but it is preferable to give them a height of only 6 inches. After the earth has been carefully and uniformly deposited in a layer it should be thoroughly rolled, parallel with the axis of the dam, with rollers weighing about 150 to 300 pounds per lineal inch. The best rollers are grooved. In ordinary material the rollers pass at least six times over every portion of each layer.

During the rolling the earth must be sufficiently moistened by sprinkling to make it pack well, but only a little water must be used—there is danger in using too much. The wetting must never be more than a sprinkling. If the material is moist, no water will be required.

After the dam has been constructed, the top and outer slope, which are to be sodded, or seeded with grass-seed, are covered with about 6 inches of good top-soil or loam. The sods used should be of good earth covered with heavy, healthy grass, and should have a uniform thickness of about 3 inches. Each sod should be at least a foot square. The sides of the sods should be bevelled so that their edges should lap. The sods should be well bedded and padded down with a spade. On slopes a



sufficient number of sods must be secured to the ground by wooden pins, about 15 inches long, to keep the sodding in place. In dry weather the new sodding should be occasionally sprinkled.

**High Earthen Dams.**—On page 401 we give a list of high earthen dams, which we reproduce by courtesy of *Engineering News*, from the book it has published on "**Earthen Dams**," by Burr Bassell, M. Am. Soc. C. E. Short descriptions of some ancient dams and of some of the highest earth dams thus far constructed are given below:

**Ancient Dams in India and Ceylon.**—From a remote period of history earthen dams were constructed in India and Ceylon to form reservoirs called "tanks" for irrigation purposes. Captain R. Baird Smith states, in his work on "Irrigation in the Madras Provinces," that there are in the Madras Presidency 43,000 tanks in repair, and 10,000 tanks out of repair, all of which were constructed by the natives. The earth dams forming these tanks aggregate about 30,000 miles in length, and, besides this, there are about 300,000 separate masonry works for the sluice-gates, waste-weirs, etc. According to H. M. Wilson, M. Am. Soc. C. E.,\* there are 37,000 tanks in the Mysore district of southern India, in addition to the 53,000 tanks mentioned by Captain Smith.

Some of the most remarkable of the ancient tanks† are the Poniary tank of Trichinopoly, now out of repair, which had an embankment 30 miles long and covered 60–80 square miles; the Veranum tank, formed by an embankment 12 miles long and covering 35 square miles, which, although very ancient, is still in use; the Chumbrumbaukum tank, having an embankment 16–28 feet high and 19,200 feet long and covering 5,730 acres, and the Cauvery-pauk tank, which has been in use for from 400 to 500 years. The last-mentioned tank is formed by an embankment  $3\frac{1}{2}$  miles long, which is revetted on the water side by a stone wall 22 feet high, 6 feet thick at the bottom and 3 feet thick at the top. This wall rises to a level 3 to 4 feet above high water in the reservoir. The crest of the embankment, which is 12 feet wide, rises 9 feet above high water. The up-stream and down-stream slopes are, respectively,  $2\frac{1}{2}:1$  and  $1\frac{1}{2}:1$ . The exposed surface of the embankment is carefully turfed and planted with grass.

In Ceylon there are 30 immense tanks, besides 500–700 smaller ones in ruins.‡ Most of these works could be easily restored to service. The great tanks of Ceylon exceed the Indian tanks in extent and grandeur. The tank of Kalaweva, constructed A.D. 459, had a circumference of about 40 miles. It was formed by an embankment 12 miles long, which had a spillway of stone.

The tank of Padavil in Ceylon was formed by an earthen embankment, 11 miles long, 30 feet wide at the top and 200 feet wide at the base, and upwards of 70 feet high. The embankment was faced throughout its whole extent with layers of squared stone. In connection with the sluiceway of this reservoir a great deal of ornamental cut stone was used.

---

\* Twelfth Annual Report of the Director of the United States Geological Survey. "Irrigation in India," by H. M. Wilson, M. Am. Soc. C. E.

† "Reservoirs for Irrigation, Water-power, and Domestic Water-supply," by James D. Schuyler, M. Am. Soc. C. E.

‡ The short descriptions given of the tanks in Ceylon were taken from "Reservoirs for Irrigation, Water-power, and Domestic Water-supply," by James D. Schuyler, M. Am. Soc. C. E.

The Mudduck Masur tank,\* built over 400 years ago and now abandoned, had a capacity of about 284,229 million gallons. It was formed by three dams. The central dam, which is 91-108 feet high and has a base of 945-1,100 feet thick, is still intact and the reservoir could be easily restored. Its failure was due to the fact that no spillway was provided.

The Giants' Tank (Kattucarre) is formed by an earth bank, 300 feet thick at base, that can be traced for more than 15 miles. The reservoir was intended to cover about 223 square miles, but was never used, owing to an error made in levels which would have obliged the water in the canal that was to feed this basin to run up-hill.

**Modern Earthen Dams in India.**—A number of important earthen dams have been built by the English engineers in the employ of the Indian Government. Two of the most important of these works were constructed in recent years in the Bombay Presidency, viz., the Ekruk tank near Sholapur and the Ashti tank on the Ashti River. A short description of these tanks is given below:

The Ekruk Dam has a maximum height of 72 feet above surface and a total length of 7,200 feet, including 1,400 feet of masonry at the north end and 1,330 feet of masonry at the south end. It forms a reservoir having a storage capacity of about 24,870 million gallons. The loss from evaporation of this reservoir amounts in eight months to 7 feet in depth.

The Ashti Dam (Fig. 52) has a maximum height of 58 feet above the surface and a total length of 12,709 feet. The crest of the dam, which is 6 feet wide, is placed 12

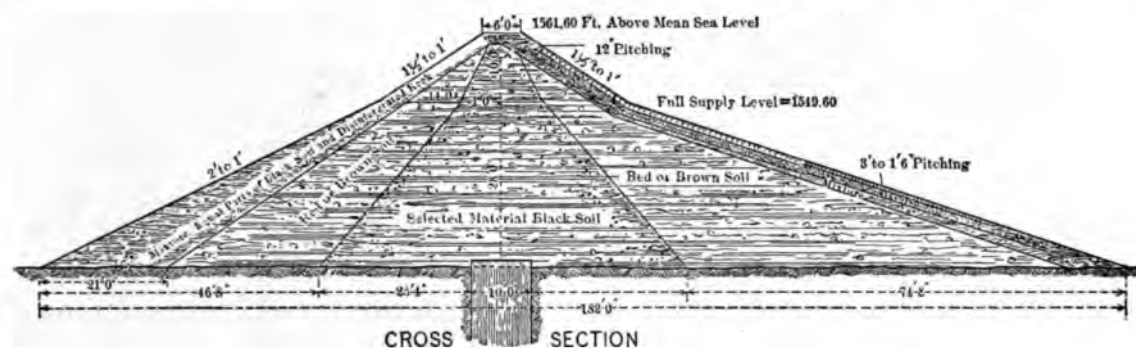


FIG. 52.—CROSS-SECTION OF ASHTI DAM.

feet above high water. The inner slope is paved with stone. The reservoir formed by the dam covers 2,677 acres and stores about 10,675 million gallons. About 28 per cent of this storage is lost annually by evaporation.

In constructing the dam the vegetation and top soil were removed from the whole site of the dam in order to place the embankment on a firm foundation. A puddle trench, 10 feet wide, was excavated to a compact impervious bed for the entire length of the dam and was filled with a mixture of two parts sand and three parts black soil (an argillaceous earth, resulting from the decomposition of trap-rock) to one foot above the natural surface. The central part of the dam was made of selected material of black soil. On both sides

\* Twelfth Annual Report of the Director of the United States Geological Report. "Irrigation in India," by H. M. Wilson, M. Am. Soc. C. E.



of this section brown soil was placed, which was faced with 1 to 15 feet of puddle made of sand and black soil. The inner slope was protected by a stone paving 6 inches thick.

A trench, 5 feet wide, was excavated across the river-bed, along the entire length of the dam, and was extended 100 feet into the banks. This trench was filled on each side with concrete and connected with the puddle trench, which was curved around the concrete wall and continued across the river at a distance of 20 feet from the concrete wall into the up-stream side.

The wasteway of the reservoir consists of a channel 800 feet wide and 12 feet deep below the crest of the dam, which was cut through the ridge rock. For 600 feet in length the crest of the wasteway is level and then slopes 1 per cent to a side channel. With 7 feet of water on its crest the wasteway discharges 48,000 cubic feet of water per second.

A serious slip occurred in the Ashti Dam in 1883 after prolonged rains. It caused a settlement of 16 feet at the crest of the dam and made the ground at the top of the dam bulge upwards. The slip was attributed to the fact that the dam is founded for a considerable portion of its length on clay soil containing nodules of impure lime and alkali, which make it semi-fluid when saturated with water. The defect in the construction was remedied by digging drainage trenches at the down-stream toe and filling them with boulders and broken stone. In addition to this, heavy berms or counterforts of earth were constructed on the down-stream slope for 700-800 feet of its length.

Similar slips, due to the same causes, occurred in the Ekruk dam and proved the necessity of thorough drainage at the down-stream slope of an earthen dam.

**The Vehar Dam** forms a reservoir covering 1,394 acres and storing 10,800,000,000 gallons for the water-supply of Bombay. The dam, which is built of earth, has a maximum height of 84 feet.

Plate XCII, taken from William Humber's "Comprehensive Treatise on the Water-supply of Cities and Towns," shows the arrangement of the outlet tower of the reservoir. The tower has four inlets, placed at intervals of 16 feet. They are 41 inches in diameter and are provided with conical plug-seats faced with gun-metal. A wrought-iron straining-cage, covered with No. 30 gauze copper wire, is placed over the inlet opening that is in use. A similar straining-cage, made of No. 40 gauze wire, is placed at the bottom of the well, over the orifice of the supply-pipe. The tower is a good example of Indian architecture.

**The Yarrow Dam**, Plate XCIII,\* was built for the Rivington Water-works of the City of Liverpool, England. It has a maximum height of 90 feet above the original surface. In order to reach an impervious stratum, the foundation trench had to be excavated to an extreme depth of 97 feet. This trench was begun with a width of 24 feet and was made with a slope of 1:1 for the first 10 feet of depth. It was then continued with slopes of 1 to 12 through sand, gravel, and boulders to bed-rock. The upper surface of the rock was found to be soft, seamy, and bearing water. The trench was kept dry by means of pumps and continued for a depth of 4-5 feet into bed-rock. In the bottom of the trench a 14-inch wall was built on either side and the space between these walls was filled with concrete, mixed in the proportion of 1 part of cement, 1 part sand, and 2 parts of gravel or broken stone. This formed a dry bed for the puddle wall. Two lines of 6-inch pipe were

---

\* Plate XCIII is taken from "The Construction of Catch-water Reservoirs," by Charles H. Beloe.

laid on the bed-rock, just outside of the walls, and pipes, 9 inches in diameter, were extended vertically above the brickwork some 27 feet. These pipes were used for pumping and were subsequently filled with concrete. The trench was refilled with puddle to the original surface, and the puddle wall was then carried up simultaneously with the embankment on a batter of 2:1.

A second dam was required in addition to the one described above to form the reservoir, which covers about 73 acres and stores about 1,000,000 gallons.

The **Druid Lake Dam\*** was constructed in 1864 to form a storage reservoir of 429,000,000 gallons capacity for the water-works of Baltimore, Maryland. The dam was built in Druid Hill Park, across a small stream having a drainage area of less than 100 acres. The principal dimensions of the dam are:

Maximum height . . . . .	119.00 feet.
“ “ of dam at outer toe . . . . .	100.33 “
“ depth “ water . . . . .	82.00 “
Width of dam at top . . . . .	60.00 “
“ “ “ “ high water . . . . .	90.00 “
“ “ “ “ base . . . . .	640.00 “
Inner slope . . . . .	4:1 “
Outer “ . . . . .	2:1 “

In building the dam the vegetable top soil was excavated to a depth of a foot from the surface that was to be covered by the embankment, except where sand was found, in which case the excavation was continued until an impervious stratum was reached. For the puddle-core that was to be placed in the centre of the dam the excavation was continued to rock, into which a groove, 5 feet wide, was cut, extending for the whole length of the dam. In this groove a wall of rubble masonry, laid in hydraulic-cement mortar, was built, the sides being plastered with mortar. It was made 4 feet wide at the base and 2 feet wide at the top. A puddle core-wall, 36 feet wide at the base and 17 feet wide at the top, was constructed on and around the stone wall.

The embankment was carefully constructed in layers. After the up-stream slope had been built of earth it was covered with 2 feet of good puddle upon which 1 foot of gravel was placed, all being carefully rolled. After the completion of the embankment the inside slope was covered with riprap of large stones from 10 feet below to 2 feet above its high-water mark. The top 6 feet of the riprap was covered with stones, 1 to 3 inches in diameter. The top of the dam, the outer slope, and the inner slope above the riprap were sodded. Some time after the dam had been completed, a driveway was constructed on the outer slope about half-way up. This driveway was supported by increasing the width of the dam at the outer slope.

The inlet-, outlet-, and drain-pipes were originally constructed through the dam at its east end. These pipes were laid in trenches upon solid earth and were supported by stone piers, 6 feet apart, where they crossed the puddle-core. The piers were carried up and

---

\* *Engineering News*, February 20, 1902.

around the pipes so as to form collars to prevent water percolating through the dam along the pipes. Some of the pipes in the earth trenches were cracked, probably because the pipes at the puddle core-wall were laid on piers, while the others were only supported by earth, thus making it impossible for the pipes to settle uniformly. The cracked pipes were removed, the ends of the remaining good pipes were closed by caps, and new inlet-, outlet-, and drain-pipes were laid on the south side of the reservoir at a point where the height of the embankment was much lower than at the main dam.

The dam was designed by Robert K. Martin, Chief Engineer of the Baltimore Water-works, and was built under his supervision. The work was begun on March 7, 1864, and was completed by January 2, 1871, when the reservoir was permanently filled. The dam has proved to be perfectly water-tight.

**The Temescal Dam,\*** California, was constructed in 1866-68 to form a reservoir for the water-supply of Oakland. The reservoir is located about  $4\frac{1}{2}$  miles from the city. The work was begun by Mr. Anthony Chabot of Oakland and was completed by the Contra Costa Water Company.

The dam was constructed in layers by means of carts and scrapers and was completed in 1868 with a top-width of 18 feet, at a maximum height of 105 feet above the bed of the creek, across which the dam was built. The slopes were originally 3:1 on the up-stream side and  $2\frac{1}{2}$ :1 on the down-stream side.

The following year Mr. Chabot, who was a practical hydraulic miner, flattened the down-stream slope by sluicing in material by the same process that is used in hydraulic mining, and in 1886 the crest of the dam was raised 10 feet by the hydraulic method. As finished the dam has a maximum height of 115 feet above the creek bed and a down-stream slope of 5:1. The reservoir formed by the dam covers 18 acres and has a storage capacity of 250,000,000 gallons.

**The San Leandro Dam †** (Fig. 53) was constructed in 1874-76 to form a reservoir for the Oakland Water-works. The dam was finished in the latter part of 1875 with a maximum height of 115 feet above the bed of the creek across which it was built. The reservoir formed by the dam covered about 400 acres and stored about 5,000,000,000 gallons. In 1898 the crest of the dam was raised 10 feet, giving the dam a height of 125 feet above the bed of the creek and the up-stream slope was reinforced at the same time. With the water-line 5 feet below its crest, the dam forms now a reservoir covering 436 acres and having an available storage of 5,826,000,000 gallons. By silting up this capacity has been reduced up to January 1, 1903, to about 5,167,000,000 gallons. The drainage area supplying the reservoir contains about 43 square miles.

Fig. 53 shows the cross-section adopted for this dam. According to the original plans the dam was to be raised 10 feet every 4 or 5 years until an extreme height of 175 feet above the creek bed should be attained. This was to be done not only to increase the storage, but also to offset the silting up of the reservoir, which averages about a foot in

---

\* *Engineering News*, September 11, 1902, and "Reservoirs for Irrigation, Water-power, and Domestic Water-supply," by James D. Schuyler, M. Am. Soc. C. E.

† *Engineering News*, September 11, 1902; "Earth Dams," by Burr Bassell, M. Am. Soc. C. E.; and "Reservoirs for Irrigation, Water-power and Domestic Water supply," by James D. Schuyler, M. Am. Soc. C. E.

depth per annum. With a view to this raising, the dam was given a much greater width of base than would otherwise have been adopted. Within a slope of 3:1 on the up-stream side and  $2\frac{1}{2}$ :1 on the down-stream side the dam was made of selected material, placed in layers about a foot thick in the usual way.

The material was dumped on the dam from carts and wagons and was sprinkled sufficiently to pack it well. No rollers were used, the earth being compacted by the carting and by a band of horses, which was led by a boy on horseback over the entire work.

A central trench was excavated 30 feet below the original creek-bed and in the bottom of this trench three secondary trenches were excavated, 3 feet wide by 3 feet deep, and were filled with concrete walls, which were carried up 2 feet above the general floor of the trench in order to break the continuity of its surface.

Outside of the  $2\frac{1}{2}$ :1 slope on the down-stream side the dam was constructed of ordinary earth and more or less rock that were sluiced in by gravity during the winter months. This process was carried on until the canyon below the dam was filled, giving an average slope of 6.7:1 on the down-stream side. Some material was also sluiced in in the up-stream face of the dam.

James D. Schuyler states in his "Reservoirs for Irrigation, etc.," that the dam as completed to a height of 115 feet in 1875 contained about 542,700 cubic yards of material, of which

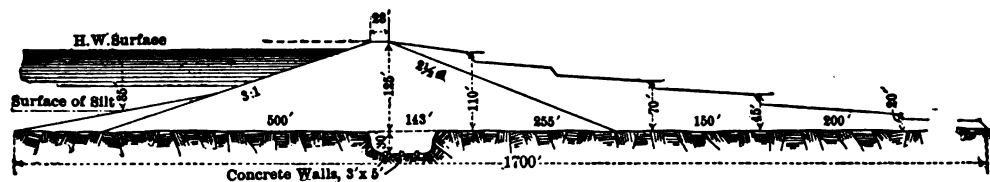


FIG. 53.—DEVELOPED SECTION OF SAN LEANDRO DAM.

about 160,000 cubic yards were sluiced in. The water used for the "hydraulic method" was brought four miles in a ditch and the material was sluiced in a flume, lined with sheet-iron plates, which was built on a grade of 4-6 per cent. About 10-15 cubic feet of water per second was used for this process. It was estimated that the hydraulic method cost only about one-fourth to one-fifth of the ordinary way of building dams by means of sweepers and carts.

The dam, as raised in 1898, is 28 feet wide on the crest and 500 feet long. The original width of the ravine at the base of the dam was 66 feet. The present width of the dam from toe to toe of slopes is 1,700 feet. The maximum depth of water to the silt in the reservoir was about 85 feet in 1902. A wasteway was originally excavated in the bed-rock of the natural hillside at the north end of the dam and was lined with masonry. It has been practically abandoned as menacing the safety of the dam, and was replaced in 1888 by a waste-tunnel, about 10x10 feet in section and 1,487 feet long, having a  $2\frac{1}{2}$ -per-cent grade. This tunnel was driven through a ridge to the north of the dam and was lined throughout with masonry. The outlet-pipes are laid in two tunnels excavated at different elevations near the dam. No pipes or culverts were placed in the dam itself.

The construction of this dam was chiefly due to Mr. Anthony Chabot of Oakland. It was probably due to his experience in hydraulic mining that a large part of the dam

was constructed by the hydraulic method. Mr. W. F. Boardman, a hydraulic engineer of Oakland, California, superintended the construction of the dam.

The Pilarcitos and San Andres Dams, California,\* were constructed to form storage reservoirs for the City of San Francisco.

The Pilarcitos Dam (Fig. 54) is 25 feet wide at the crest and 640 feet long. It is 95 feet high above the original surface of the ground. Its down-stream slope is  $2\frac{1}{2}:1$  and the up-stream slope is 3:1 for a certain distance at the bottom and then  $2\frac{1}{2}:1$ . The

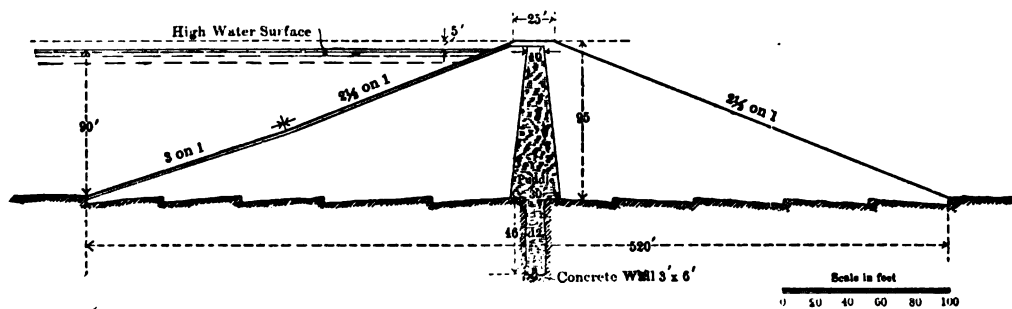


FIG. 54.†—CROSS-SECTION OF PILARCITOS DAM.

dam is provided with a centre puddle-wall which extends down 40 feet below the surface into a trench cut in the rock. The reservoir formed by the dam, which is 696 feet above the sea-level, stores about 1,180,000,000 gallons.

The San Andres Dam (Fig. 55) is 25 feet wide on top and 850 feet long. Its up-stream and down-stream slopes are respectively 3.5:1 and 3:1. Originally the dam was only

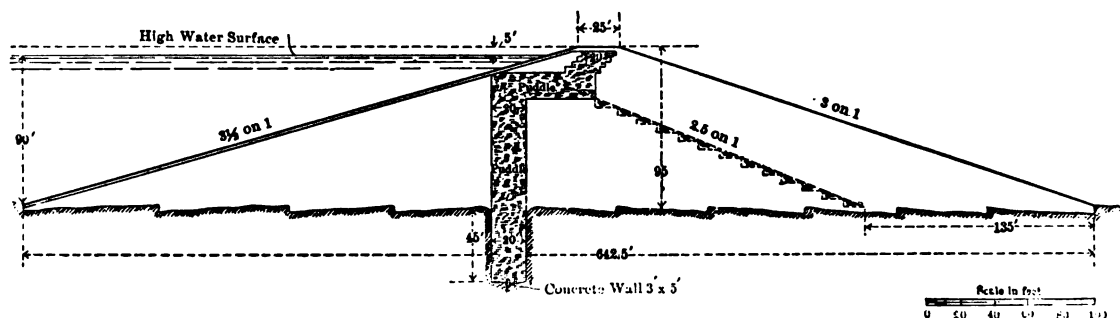


FIG. 55.—CROSS-SECTION OF SAN ANDRES DAM.

77 feet high above the surface, but in 1875 it was built up 16 feet higher, giving it a height of 93 feet above the surface. The base of the dam, as finished in 1875, is 135 feet wide. The central puddle-wall extends through 46 feet of earth and gravel to bed-rock. As the up-stream slope was continued in the same plane in the raising of the dam, the puddle-wall had to be built at the top on an offset, as shown in Fig. 55, in order to keep it in the centre of the dam.

The reservoir formed by the dam stores about 6,500,000,000 gallons.

\* "Reservoirs for Irrigation, Water-power, and Domestic Water-supply," by James D. Schuyler, M. Am. Soc. C. E.

† Figs. 53 and 54 are taken from "Earth Dams," by Burr Bassell, M. Am. Soc. C. E.



tudinal axis the rock was satisfactory, but above the quartz vein fissures and springs occurred.

A system of drains was placed in the excavation in bed-rock in order to remove the water from the springs during construction and to intercept seepage after the reservoir was filled. The drains were generally made either with stone or of small pipes that were protected by inverted angle-irons. According to circumstances the drains were either covered with fine gravel or concrete and then with clay puddle. The main drain consists of an 11-inch iron pipe, which was laid to a weir-box outside of the down-stream slope at a distance of 500 feet from the axis of the dam.

The embankment was made of a red gravelly clay, which was almost an ideal material for constructing a homogeneous dam. The puddle placed on the up-stream slope was only used to "make assurance doubly sure," and was not extended to the top of the dam. As the upper surface of the slate bed-rock was found to be badly fissured, especially near the up-stream toe, and as the rock was not very deep below the surface, the excavation was made to bed-rock for the entire up-stream half of the dam. At the axis of the dam and where the puddle face abutted against the hillsides the excavation was also made to rock. The material placed in the dam was obtained near by from borrow-pits within the limits of the reservoir or at the ends of the dam.

The surface of the ground was plowed and the earth was excavated by means of a steam-shovel and scrapers, and loaded through earth traps into dump-wagons, each holding 3 cubic yards. The wagons, which weighed loaded about 6 tons each, were hauled by 4-horse teams, and the earth was dumped on the dam in long rows, through swinging bottom doors, while the wagons were in motion. These rows were generally parallel with the axis of the dam, except at the ends, where a few rows were made parallel with the intersection of the embankment with the hillsides. The best material was placed on the up-stream half of the dam and at the ends. After the earth was dumped, all roots, stones weighing over five pounds, and other unsuitable material were removed by rock-pickers, who were continually passing along the rows with their carts. The rows were then leveled by 6-horse road-graders and the material was then harrowed and rolled, being sprinkled by water-wagons and by hose and nozzles, as required. The top of the dam was kept basin-shaped during the construction, with a slope of about 1 in 25 from the sides to the centre. This made the central part of the dam receive more water than the other, any excess being carried off by the drains in the foundation.

The specifications required the body of the dam to be constructed in 6-inch layers up to a height of 60 feet and permitted 8-inch layers to be used above this elevation. The thickness of the layers was regulated closely by spacing the rows of earth. The top surface of every finished layer was thoroughly sprinkled and harrowed before the next layer was placed.

Two rollers, each drawn by six horses, were kept constantly in use. One weighed five tons and the other 8 tons, the pressure per lineal inch for the rollers being, respectively, 166 and 200 pounds. The rollers were not grooved, but the smooth surface they left was always harrowed and more or less cut by the passing wagons, which when loaded had a pressure of 750 pounds per inch on their wheels. The wagons were found to compact the earth even more than the rollers. In the bottom trenches some tamping had to be

done by hand and by the trampling of the horses. The trenches were made sufficiently wide to permit the horses to turn in order to have the material in the trenches tramped as much as possible.

The outlet from the reservoir is a tunnel 2,903 feet long, which was driven through solid slate rock in the ridge dividing the watershed of Jackson Creek and Montelumne River. This tunnel is reached from the reservoir by an open cut 350 feet long and at the other end by a cut 39 feet long, each cut having a maximum depth of about 26 feet. The section of this tunnel consists of a rectangle, 6 feet wide by 4 feet high, on top of which there is a semicircle of 3 feet radius. The area of the cross-section of the tunnel contains about 40 square feet.

The water from the reservoir fills the tunnel to a point near the south portal (the one farther from the reservoir), where a receiver is placed and connected with the tunnel by a short pipe-line, 60 inches in diameter. About 175 feet from the receiver a water-tight bulkhead of brick and concrete masonry is built in the tunnel. In the line of 60-inch riveted steel pipe, which connects the reservoir and tunnel with the receiver, there is placed a cast-iron chamber for entrapping silt or sand, with a branch pipe 16 inches in diameter, leading into a ravine, through which sand or silt thus collected can be wasted or washed out. All controlling devices, screens, gates, etc., are at the south end of the tunnel and easily accessible.

The spillway is some distance from the dam. It consists of a cut, 48 feet wide at the bottom and 300 feet long, which was excavated through a hill and discharges into a ravine that joins the main valley 500 feet below the dam. The sill of the spillway is 10 feet below the top of the dam.

The Tabeaud Dam, not including the foundation, was built in eight months, under the direction of Burr Bassell, M. Am. Soc. C. E.

**Dams for the Water-works of New York.**—A number of earthen dams have been built in the Croton watershed to form, either alone or in connection with masonry dams, storage reservoirs for the water-works of New York. They have all been built with masonry core-walls, according to similar plans. The highest of these dams was built as an extension of the masonry dam forming the Titicus Reservoir, q.v.

According to the contract plans, part of the New Croton Dam was to consist of an earthen embankment (see p. 163) which was to be constructed according to the cross-section shown in Plate XCIV, and the specifications given on page 367 of the Appendix, with its top 10 feet above the crest of the masonry dam. This embankment was to have a maximum height of about 120 feet above the surface of the ground, a top width of 30 feet, and slopes on both sides of 2:1. The down-stream slope was to be broken by two berms, 5 feet wide, made, respectively, 30 and 60 feet below the top of the dam. The berms were to be ditched and paved to carry off rain-water. The up-stream slope was to be protected by a stone paving 2 feet deep, which was to be placed on 16 inches of broken stones. This paving was to extend to a level 10 feet above the high-water mark. The top of the dam, except where the roadway was to be formed, the up-stream slope above the paving, and the down-stream slope were to be covered with good soil and sodded.

The construction of this embankment was carried on from the letting of the contract in August 1892, until the fall of 1901. The discovery of some cracks in the core-wall



of the dam, which was to have a maximum height of about 200 feet, gave rise to some apprehensions with reference to the water-tightness and safety of the embankment. Upon the recommendation of the then Chief Engineer, Wm. R. Hill, M. Am. Soc. C. E., the Aqueduct Commissioners, who had charge of the construction of the New Croton Dam, appointed, in June 1901, a Commission of Engineers to examine the plans for the construction of the dam and to report what changes, if any, should be made.

This Commission, which consisted of J. R. Croes, Edwin F. Smith, and Elnathan Sweet, all members of the Am. Soc. C. E., made a very careful examination of all the earth dams that had been built or were in construction in the Croton watershed. Specimens of the materials of which these embankments were made were examined with reference to impermeability in the Cornell hydraulic laboratory and pipes were driven in the inner and outer slopes to determine whether any water had percolated through the dams.

The dams in the Croton watershed are made of glacial drift in which the materials are not evenly distributed so as to form a homogeneous mass. Distinct layers of gravel, boulders, and beds of sand occur in the borrow-pits from which the dams were made, and, also, large pockets of very fine sand, with a small amount of clay, forming a very compact material when not exposed to the action of water, but dissolving readily and becoming quite fluid when reached by water.

In all dams on which observations were made the up-stream slopes were found to be completely saturated with water. In nearly every case water was also found in the down-stream slopes, but the extent of saturation in these slopes varied very greatly, according to the materials used and the care taken in the construction. In the case of the Titicus Dam (described on page 148) the core-wall proved to be impervious, no water being found in the outer slope of the embankment, until a depth of 40 feet below the reservoir level was reached. The presence of this water was readily accounted for by the supposition that there was a slight flow of ground-water from the natural surface which rises from the core-wall at this point and forms a pocket. When this confined water can escape to the toe of the embankment, it assumes a slope of 10.7 in 100, indicating that the embankment is quite porous.

In the outer slopes of the other dams examined the water appeared to be coming from the reservoirs, either by leakage through or under the core-walls, or through fissures in the rock. Water was found in the outer slopes of these dams at depths below high water varying from 7 to 26 feet, and was found to assume slopes varying from 17:100 to 40:100. The more compact the material in the embankment was the steeper the slope of saturation was found to be.

As the result of its observations, the Commission reached the conclusion that in the case of the earth embankment of the New Croton Dam, whose crest was assumed to be 20 feet above high water, the loss of head caused by the core-wall would probably be 21 feet and that the slope of saturation would probably be 20 feet in 100 feet. On this basis the Commission did not consider it safe to construct the earth embankment of the New Croton Dam to a greater height than 70 feet. The Commission recommended that the core-wall and embankment of the New Croton Dam be removed and replaced by a masonry structure similar to that built for the main part of the dam. This recommendation was carried out by the Aqueduct Commissioners.

The conclusions of the Commission were disputed by other prominent engineers, including A. Fteley, Past-President, Am. Soc. C. E., who had designed the New Croton Dam.

The report of the Commission is given in full in the *Engineering News* of November 28, 1901, and the comments on this report by Mr. Fteley and other engineers are printed in the *Engineering News* for 1901 and 1902.

At the time the change in the plans recommended by the Commission took place, more than half of the core-wall and about half of the earth embankment had been constructed. The change made involved considerable expense and loss of time.

The question whether this modification in the original plans was necessary is considered by Charles S. Gowen, who was Division Engineer in charge of the construction of the dam, in a paper read before the American Society of Civil Engineers in January 1906, and by a number of prominent engineers who discussed Mr. Gowen's paper.

**The North Dike of the Wachusett Reservoir** \* was constructed in 1898-1905 to assist in retaining the water in the Wachusett Reservoir of the Metropolitan Water-works of Boston, Massachusetts. The dike is built across a sandy plain having a general level of about 15 feet below the water-level of the reservoir. Its location was determined by numerous wash-drill borings. In all 1,131 borings were made, having an aggregate depth of 17½ miles. The average depth to rock was 83 feet and the maximum depth was 286 feet.

The north dike is of unusual dimensions. As it had been decided, upon sanitary grounds, to strip the surface soil from the whole of the 6½ square miles comprised within the limits of the reservoir, a superabundance of material was available for the construction of the dike. It was decided, therefore, to give the dike an unusual width, in order to make percolation through it practically impossible and also to insure absolute safety.

The dike has a length on the water side, at the full reservoir level, of about 2 miles. It covers an area of 143 acres and contains about 5,500,000 cubic yards of material. At the deepest place the dike is 65 feet high to the full-reservoir level and has a maximum width of 1,930 feet.

The upper layers of the plain on which the dike was built consist generally of coarse sand or fine gravel. In order to prevent the percolation of water through these layers, a cut-off trench was excavated in such places, extending longitudinally under the crest of the dike. This trench has a total length of 9,556 feet, a bottom width of 30 feet, and a maximum depth of 60 feet. For 3,124 feet the trench was excavated in rock and for the remaining distance into fine sand. Wherever the material was such that percolation below the level of the cut-off trench was feared, sheet-piling was driven in the bottom of the cut-off trench. This sheeting was driven for 5,245 feet of the trench, leaving 1,187 feet of the trench without sheeting.

The top of the dike was finished 17 feet above high water, allowing for a probable settling of 2 feet. The width of the dike at full-reservoir level is 189 feet. The downstream slope is, as a rule, 3 in 100. But there are some exceptions, and at one place the slope is 6 in 100. On the water side the slope is 2 in 1, both above and below a berm 15 feet wide, which is made 13 feet below the full-reservoir level. Above the

---

\* Description by Frederick P. Stearns, Chief Engineer, in *Trans. Am. Soc. C. E.*, Vol. XLVIII, page 259. See also *Engineering News*, May 8, 1902.

berm the slope is protected by a layer of coarse gravel, 7 feet thick, resting on an embankment of either sand or gravel. Upon the coarse gravel a paving, 3 feet thick, of large stones embedded in and chinked with broken stones, is placed. This paving extends from 8 feet above the water-level to the berm, but diminishes in thickness towards its upper and lower ends. Below the berm the slope is only protected by a layer of coarse gravel, except in a few exposed places where riprap is used.

The cut-off trench was excavated with slopes of 1:1, as this was found to be more economical than vertical sides and facilitated the work of driving the sheet-piles. This trench furnished most of the sand and gravel that was placed in the dike at its water side. A secondary cut-off trench of somewhat smaller dimensions was provided for a part of the length of the dike, as an additional precaution. The cut-off trenches were refilled with soil compacted by being saturated with water, which experiments showed to be practically water-tight.

The preliminary borings showed that in some places fine sands that were not wholly impervious extended to a depth of 50 feet below the bottom of the cut-off trench. As the sand was free of stones the sheet-piles were driven by means of a water-jet. It was found to be impracticable to obtain single planks for such long sheet-piles, and, where the length exceeded 30 feet, the sheeting was made 6 inches thick and composed of 2-inch planks put together substantially as the Wakefield triple-lap sheet-piling. The planks were planed to an even thickness and nailed together, except at the lower end, where they were bolted together to resist water pressure. The piles were beveled at the bottom for a part of their width to make them keep close to the piles against which they were driven. For lengths of less than 30 feet, 4-inch grooved spruce sheeting was used.

In making the preliminary investigations for the construction of the dam numerous experiments were made upon the filtration of water through soils and sand, on the density of soil compacted in various ways and on the stability of soils under heavy loads.

Experiments were also made with dikes which were built in a water-tight wooden tank, 6 feet wide, 8 feet high, and 60 feet long, which was constructed in a building, 25 feet wide by 70 feet long. The soil was deposited in the dikes in different ways: (1) Shoveled loosely into the tank without consolidation of any kind; (2) deposited by shoveling the soil into water.

Water was admitted to one side of the dike experimented on, and the amount of percolation measured on the other side. It was found that soil that had been thrown in loosely in a dike settled, as it became saturated with water, and became quite compact. After the dike had been subjected to water pressure for several weeks, the percolation amounted to only 1 gallon in 22 minutes.

The work was constructed under the direction of Frederick P. Stearns, M. Am. Soc. C. E., Chief Engineer of the Metropolitan Water and Sewerage Board of Boston, Massachusetts.

**The Belle Fourche Dam\*** (Plate XCV) is now being constructed across Owl Creek, just below the mouth of Dry Creek, about ten miles northeast of the town of Belle Fourche, South Dakota. It will form a reservoir for storing water for irrigation, having a capacity of about 66,500,000,000 gallons.

---

\* Fourth Annual Report of the Reclamation Service of the United States Geological Survey

The dam will be 6,500 feet long and 20 feet wide on top. Its maximum height above the bed of Owl Creek will be 115 feet. The up-stream slope will be 2:1 below the highest water-level and 1:1 above this elevation. It will be protected from wash and ice action by 2 feet of screened gravel, rolled into place on the slope, on which concrete blocks, 4'×6' and 8 inches thick, will be placed. The down-stream slope will be 2:1 in the lower portion and 1.75:1 in the upper portion. It will be provided with concrete gutters for disposing of the rainfall and will be fertilized and seeded with grass to prevent erosion. The dam will be made of heavy clay and gumbo, weighing in some places 120 pounds per cubic foot, and will be built in layers, the material being sprinkled and rolled with heavy steam-rollers.

The reservoir will have two outlet conduits of concrete and steel, surmounted with towers and gathouses for delivering the water into two distributing canals, known respectively as the north and the south canal.

A semicircular waste-weir of concrete will be provided at the high-water line beyond the north end of the dam.

The contract for the construction of the dam was given on November 14, 1905, to Orman & Crook of Pueblo, Colorado, and up to March 1, 1907, 9½ per cent of the work of constructing the dam had been performed.

The work is being done under the direction of the United States Reclamation Service, of which F. H. Newell, M. Am. Soc. C. E., is Director, and A. P. Davis, M. Am. Soc. C. E., is Chief Engineer.

Charles E. Wells, M. Am. Soc. C. E., is Supervising Engineer, and Raymond F. Walter is the Engineer in charge of the Project. The dam is being built under the superintendence of Walter W. Patch, Assoc. M. Am. Soc. C. E., Constructing Engineer, at Orman, South Dakota.

**Failures of Earthen Dams** have been very numerous. The cause of the rupture has generally been a neglect of some detail in the construction,—as an insufficient length of spillway or of the waste channel below it, a faulty manner of laying the outlet-pipes in the dam, etc. The two greatest disasters resulting from the failure of earthen dams occurred in Sheffield, England, on March 11, 1864, and in Johnstown, Pennsylvania, on May 31, 1889. As they teach some important lessons, we shall describe briefly the facts connected with these failures.

**The Dale Dyke Dam** formed the Bradfield reservoir for the water-supply of Sheffield. This reservoir covered 78 acres and stored 114,000,000 cubic feet. The dam was 95 feet high, 1254 feet long, 12 feet wide on top, and 500 feet at the base. Both slopes were 2½ to 1. The puddle-core was 4 feet wide on top and 16 feet at the surface, both faces being battered 1½ inches per foot. To reach an impermeable stratum the puddle-trench was excavated for a great part of its length to a depth of 60 feet. Two 18-inch socket-jointed cast-iron outlet-pipes (1½ inches thick) were laid naked in a trench under the dam at its highest point. The pipes were placed 2 feet 6 inches apart. The whole trench was refilled with puddle, 18 inches of this material being placed both below and above the pipes. Where this trench crossed that of the puddle-core of the dam, it was excavated to the depth of the latter.

In constructing the dam, the engineers adopted the rather original plan of making the inner part of the embankment as much as possible of rubble-stone and shale.\* They based this preference on the idea that earth becomes saturated by water and assumes a flatter slope, while a pervious bank, made principally of stone, will keep its slope. By this arrangement, however, the whole hydrostatic pressure of the water was brought directly against the puddle-core. If settling caused the least crack in this puddle, the water was sure to find its way rapidly through the dam. While the puddle-core is to act as a cut-off in the heart of the bank, an inner slope of well-packed earth should prevent the water from percolating to the centre of the dam, as much as possible.

The reservoir was full when the dam failed, and a narrow crack had appeared on the outer slope. In the investigation which followed the rupture of the dam, the greatest engineers of England testified as experts. Their opinions, as regards the cause of the bursting of the dam, varied very much, and it will never be known what started the failure. It is evident, however, that the plans of the dam were very unsafe in requiring the outlet-pipes to be laid unprotected in the dam, and the inner part of the dam to be made of stone and shale.

**The Johnstown Disaster**, which caused the loss of more than two thousand lives and of millions of dollars' worth of property, resulted from the rupture of an earthen dam which was built across the south branch of the Little Conemaugh River in Pennsylvania. The dam was 70 feet high, and 10 feet wide on top. The inner and outer slopes were respectively 2 to 1 and  $1\frac{1}{2}$  to 1. In this case the inner slope was made of earth properly rolled, but stone was placed in the outer slope. The failure, which occurred after an unprecedented rain-storm, was due to the insufficiency of the waste-weir, which was partly obstructed by fish-screens. At 11.30 A.M. the water commenced to pass over the top of the dam, and it rose to a height of 20 inches above the dam. The water gradually cut a channel through the embankment, until at 3 P.M. the dam burst.

If this dam had been provided with a masonry core-wall, carried up to the high-water mark, the water, instead of cutting a channel through the bank, would have washed away the earth to the top of the core-wall. This wall would have formed a long waste-weir which would not have been ruptured until the outer slope was washed away, and even then only the highest part of the wall might have given way. Considering the fact that the outer slope of the dam was made largely of stone, it is quite probable that the Johnstown disaster would not have occurred if the dam had had a core-wall. Such a wall, besides making a dam water-tight, may be considered as a safeguard against the erosive action of water that may pass over the top of a dam during a great flood.

---

\*See "The Designing and Construction of Storage Reservoirs," by Arthur Jacob, B.A.

## CHAPTER II.

## DAMS MADE BY THE HYDRAULIC PROCESS.

A NOVEL manner of building dams of earth and gravel has been used in some of the Western States. It consists in excavating, transporting, and depositing the material required by the erosive action of water, which is obtained either under pressure from a jet or by gravity from a flume. This method, which was first introduced for what is known as "hydraulic mining," was soon applied in making small dams in California and was used, also, on a very extensive scale, in making embankments for the Northern Pacific and Canadian Pacific Railways. The dams of the Temescal and San Leandro storage-reservoirs for the water-supply of Oakland, California, were partly constructed in this manner (see preceding chapter), and within the last few years a number of dams in the Western States have been constructed by this process.

According to James D. Schuyler,\* M. Am. Soc. C. E., the theory on which such dams are generally planned is:

First: That the inner third of the dam should be composed of material which should consolidate into a mass impervious to water.

Second: That the outer half of each of the other thirds of the dam should consist of coarse, porous material, permitting the passage of water, and

Third: That the inner halves of the outer thirds of the dam should be a mixture of coarse and fine material, which should act as a filter to retain the fine particles of the inner third, while allowing water to percolate slowly.

In order to carry on the hydraulic process of dam construction efficiently, water should be obtained by gravity in a volume of 10 to 15 cubic feet per second, with a pressure of 100 to 150 pounds per square inch at the nozzle of the monitor (the name given to the hydraulic machine used in this method).

The earth eroded by the water at the borrow-pit is sluiced to the dam in a flume or pipe which is carried across the valley at the site of the dam on a light trestle. Lateral flumes or pipes are placed at suitable distances to distribute the sluiced material to the different parts of the dam.

**The Dam at Tyler, Texas**, was built in 1894 by the hydraulic process. The dam is 575 feet long and 32 feet high. The inner and outer slopes are respectively 3 to 1 and 2 to 1. The maximum depth of the water in the reservoir is 26 feet. All the material used in the dam was sluiced in from a hill near by. The average cost of the

---

\* Paper on "Recent Practice in Hydraulic-fill Dam Construction" in Trans. Am. Soc. C. E., June 1907.

PLATE X.



BEGINNING THE CONSTRUCTION OF LA MESA DAM.  
(From "Eighteenth Annual Report of U. S. Geological Survey.")





dam, including the plant and all the appurtenances of the reservoir, was  $4\frac{1}{2}$  cents per cubic yard.

In this case the water required for sluicing was obtained from a 6-inch pipe from the old city pumping-station. This pipe terminated with a common fire-hydrant about half-way up the hill from which the earth was to be washed. An ordinary 2- $\frac{1}{2}$ -inch hose, with a nozzle 1 $\frac{1}{2}$  inches in diameter, was connected with the hydrant and delivered the water, at the place where it was required, under a pressure of 100 pounds per square inch. The stream from the nozzle was directed against the face of the hill. The cutting made by the jet was carried into the hill on a 3 per cent grade. A working-face of 10 feet high was soon obtained and gradually increased to 36 feet. The jet was directed against the face so as to undermine it, and the water washed the material (clay, sand, and loam) to the dam. About 65 per cent of this material was sand, and 35 per cent clay and loam.

The work on the dam was begun by digging a trench 4 feet wide from the surface down into the clay subsoil, a depth of several feet. This trench was then filled with selected puddle-clay which was sluiced into place. The slopes of the dam were then defined by low ridges made by the laborers with hoes, and a flow of water carrying sand and clay was maintained over the top of the dam, the water being drawn off from time to time at either slope. The material was conveyed from the bank in a 13-inch sheet-iron pipe having loose joints, stove-pipe fashion. This pipe extended from the bank to and across the dam on its centre-line. The joints could be readily uncoupled and the stream directed so as to carry the bank up uniformly. The quantity of solids brought down by the water was found to vary from 18 per cent in clay to 30 per cent in sand. As sharp sand does not flow as readily as rounded sand or gravel, the delivery was increased by mixing clay and stones with the sand.

The entire cost of this dam is given as \$1140. The reservoir formed by it covers 17.7 acres and stores about 77,000,000 gallons. The dam is reported to be water-tight.

La Mesa Dam, California, was constructed in 1895 to store the flood-water of San Diego River. The dam (Fig. 57) is 66 feet high, 20 feet wide on top, and

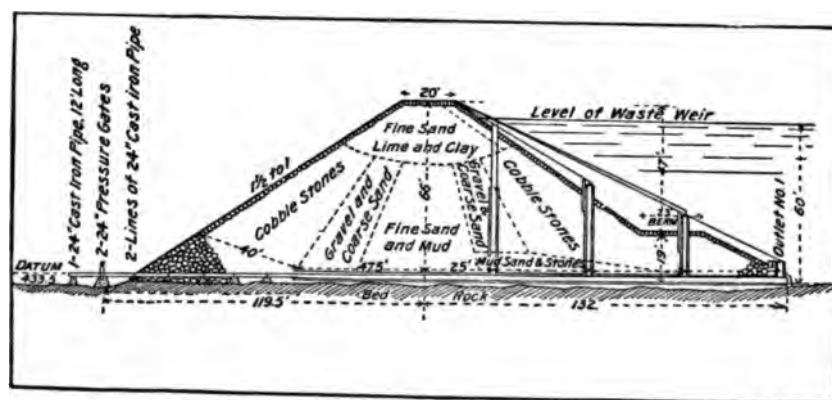


FIG 57.—CROSS-SECTION OF LA MESA DAM.

251.5 feet at the base. It consists partly of a rock-fill and partly of a bank of earth. The material was transported and deposited in the fill by water by the process

known to miners as "ground-sludging." The surplus water from a flume of the San Diego Flume Company was used for the purpose and was stored in the reservoir as the fill rose in height.

The dam is located in a very narrow gorge cut through porphyry. The valley is only 40 feet wide at the bottom, and one side is almost vertical for 40 feet. According to the original plans a rock-fill with plank-facing was to be built at this site. This dam was to be 55 feet high. Its top-width was to be 12 feet, and the up-stream and down-stream slopes were to be respectively  $\frac{1}{2}$  to 1 and 1 to 1. The length on top was to be 470 feet. The lowest bid received for building this dam, exclusive of the plank facing, outlet-pipes, and gates, was \$20,260. As a lower bid was received for building a dam by the hydraulic process, that method was adopted and the dam was built at a total cost of about \$17,000, including plant, excavation of foundations and spillway, outlet-pipes, culvert and stand-pipes, paving of slopes, etc.

About 38,000 cubic yards of material was put in the dam. It was obtained by stripping 11.5 acres, situated about 2200 feet from the dam, a mean depth of 2 feet. Below the depth of 2 feet the material was found to consist of gravel and cobbles, which were cemented together so hard as to resist washing. This necessitated the use of scrapers to bring the material to the sluiceway and increased the cost considerably. If all the material could have been transported directly by the hydraulic process, the dam would probably have cost 25 to 30 per cent less.

The gravel put in the dam varies from egg size to cobbles 8 to 10 inches in diameter. The largest cobbles were laid by hand on the outer slope so as to form a dry wall of uniform batter.

The amount of water available for building the dam was only from 300 to 400 miner's inches (6 to 8 second-feet). From the end of the flume from which the supply was obtained, the water was siphoned across a deep ravine in a 36-inch wooden-stave pipe, 3000 feet long, which emptied into a ditch 1.5 miles long, extending to the top of the ridge on the south side of the dam. Lateral ditches were carried from various points on the main ditch down the slope on 6 per cent grades. They divided the ground into irregular zones, 50 to 100 feet in width and several hundred feet long. These divisions were stripped to the rock, beginning next to the dam and working towards the ridge. The fall from the upper (clear-water) ditch to the lower side of a zone was made as great as possible. When the slope became flatter than 1 in 4, the velocity of the water was reduced so as to become insufficient to erode the material. In such cases the hydraulic process had to be assisted by the use of scrapers and ploughs, where the ground was not too soft for teams, or by hand labor.

The stream of water carrying its load of earth and gravel was conveyed along the line of the lower ditch through a 24-inch wooden-stave pipe to the fill where the material was to be deposited. This pipe was found to wear out very rapidly and had to be lined with strap-iron or tire-steel. Cast-iron pipes would have been preferable for this kind of work. An embankment made by this process becomes so thoroughly compacted that no rolling is required to prevent settling. In building this dam a force of 27 to 45 men, divided into three 8-hour shifts, placed 700 to 1400 cubic yards a day. Two men were always kept on the dump directing the stream of material, the

other laborers being needed for the ground-slucing. The upper 12 to 15 feet of the dam was finished by hauling in material with wagons.

Before beginning the dam a trench, 2 to 5 feet deep, 20 feet wide at the centre, and 5 feet wide at the ends, was excavated to the bed-rock on the longitudinal axis of the dam. The material excavated from the trench was thrown on both sides and forms part of the embankment.

Water is drawn from the reservoir through two lines of 24-inch cast-iron pipes, which extend through the dam at its widest part, for 72 feet from the outer toe, and connect with a concrete conduit (48 inches wide and 30 inches high) which connects with the reservoir. Four stand-pipes, consisting of 24-inch vitrified pipes, which are surrounded with concrete, connect with the conduit. Their tops are placed at different levels. Each of these stand-pipes is provided on top with a brass ring and flap-valve, which is operated from the top of the dam by means of rods, laid on the inner slope. During the construction of the work these pipes served to admit the water into the reservoir after it had deposited its load of gravel and sediment. The pipes were carried up a joint (2 feet) at a time. As the stand-pipes are placed on the inner slope, the coarser material was deposited by the water in the outer slope, and the fine sand at the reservoir. This is just as it should be. An advantage of making a dam by the hydraulic process is that the work is tested, as it progresses, by the pond of water that collects behind it.

This dam is not free of leakage. With 46 feet of water the loss amounted to only 23 gallons per minute, but it increased to 100 gallons per minute when the water reached the 54-foot level. It is intended to cover the water-slope with a facing of asphaltum cement concrete.

**Recent Hydraulic-fill Dams.**—In a paper presented, on December 19, 1906, to the American Society of Civil Engineers, James D. Schuyler, M. Amer. Soc. C. E., gives an interesting account of "recent practice in hydraulic-fill dam construction." The following descriptions of dams repaired or built by the hydraulic method are condensed from Mr. Schuyler's valuable paper.

**The Lake Frances Dam** was constructed in 1899 on Dobbins Creek, in Yuba County, California, to form a reservoir of 228,500,000 gallons capacity. The watershed supplying the reservoir has a yield varying from practically nothing to 1000 cubic feet per second. On October 21, 1899, a few days after the dam had been completed, a rainfall of 9 inches in 36 hours occurred, which caused the reservoir to fill very rapidly. When the water had risen to within 6 feet of the spillway the dam was ruptured at a point where it had settled, a gap being formed in the dam 98 feet wide, measured on the crest, and 30 to 40 feet wide at the bottom. In 1901 this gap was filled by the hydraulic sluicing process and the dam was raised an additional height of 27 feet by the same method.

As originally constructed the dam had a height of 50 feet, a length on top of 992 feet, and slopes of 2 to 1 and 3 to 1, respectively, on the down-stream and up-stream sides. The crest of the dam, which was carried up 4 feet above the spillway, was 16 feet wide. The spillway, which

was excavated in earth and lined with a wooden flume of 2-inch plank, had a width of 40 feet. The outlets of the dam consisted of two 36" cast-iron pipes laid in trenches 15 feet apart from centre to centre, about 100 feet east of the creek-bed, and a 16-inch riveted steel scour-pipe laid at a lower elevation in the creek channel. The sluice-gates of these pipes were operated from light steel towers standing in the water of the reservoir.

For two thirds of its length from the south end the dam was built with slip and wheel scrapers and rolled in the usual manner. For the remaining part, which was built late in the season after the water-supply had practically failed, no attempt was made to place the filling in layers. Towards the end there was such haste to complete the dam that the earth was dumped in the most convenient manner, as in an ordinary railroad embankment. Much of the steep slope on which the dam was constructed at its north end was not cleared of stumps and roots. The earth of which the dam was constructed consisted of red clay and gray sandy soil resulting from the disintegration of syenite devoid of mica.

When the dam was ruptured, the first symptom noticed was considerable leakage along the outlet-pipes. A few minutes later, a large stream appeared near the steep bank, about 100 feet west of the original creek channel and 20 feet above the base of the dam. This stream enlarged very rapidly and washed away about 20 per cent of the material of which the dam had been constructed. Some of the cast-iron outlet-pipes were broken by the pressure of the earth and the softening of the foundation under them.

In 1900 James D. Schuyler, M. Am. Soc. C. E., was engaged to report on the best manner of repairing the dam. He associated with himself J. M. Howells, M. Am. Soc. C. E., who was assisted by F. S. Hyde, Hydraulic Engineer, who had been in charge of the construction of the La Mesa Dam in California. These engineers deemed it unwise to repair the dam by simply filling in the gap, as it was liable to fail at some other point, and, as unequal settlement would occur between the old and the new part, they recommended that a heavy layer of earth be placed against the up-stream slope, of sufficient thickness to give an impervious core of selected fine clay between porous zones of coarse, stable material, one of which, next to the dam, should be of sufficient thickness to drain properly the clay core down along the slope of the old embankment to a stone drain, which was to be carried along its upper toe and connected with a drainage-pipe. An outer permeable layer of stone and sand was required to give stability to the 3 to 1 slope of the outer face. These three layers were to have an aggregate thickness of 125 feet, measured horizontally. As this plan would give the dam a crest width of 141 feet, it was recommended that its height be increased by 27 feet, the storage of the reservoir being thus increased to about 760,000,000 gallons. With the proposed increase in height the length of the dam along the crest was to be 1,300 feet. It was recommended that the width of the spillway be increased to 80 feet, in addition to a five-foot culvert through the dam, near the bottom, which was to be opened during floods, and that the crest of the dam be raised 6 feet above the spillway. These recommendations were accepted and the repairs and raising of the dam were carried out in 1901 to 1905, under the immediate direction of Mr. Hyde.

The only available water was to be found in Dobbins Creek, the flow of which is reduced during the dry months to 1 cubic foot per second, and is at times a mere trickle. A small crib-dam was built about 300 feet below the main dam, and 150,000 gallons were stored before the sluicing began.

At first the water was raised to the monitor by means of a 6-inch single-stage centrifugal pump,

which was direct-connected to a 30-h.p. motor, supplied with electricity from a power-house two miles distant. This pump delivered 1.76 cubic feet per second under a head of 100 feet. The water sluiced, through 11-inch pipes, 4,090 cubic yards of earth into place from a hill near by at an expense of 18.27 cents per cubic yard. The average ratio of solids deposited to water pumped was 13 per cent.

The muddy water draining from the dam and overflowing from within the levees, thrown upon each slope in the break, after depositing its load of earth, was caught in the little reservoir below and pumped over and over again.

The small centrifugal pump was soon replaced by a two-stage tandem centrifugal pump capable of delivering 6 cubic feet per second under a pressure of 120 lbs. per square inch. The water was delivered through a line of 20-inch pipe, varying from 300 to 700 feet in length, and the material was sluiced to the dam through a 22-inch riveted pipe laid on a grade of 3 per cent. This pipe was carried across the dam, on a grade of 2.2 per cent, on a trestle having an average height of about 25 feet. It was erected on a line parallel with the axis of the dam, and far enough inside of the slope lines to make it possible to reach the slope with lateral flumes of moderate length. The posts of the trestle were left in the embankment.

Owing to the great length of the dam and to the fact that all material had to be obtained from one side, very low gradients had to be adopted for the sluice-pipes. This made it impossible to use much of the rock found in the borrow-pits. Most of the material sluiced was clay. As not enough rock and gravel was deposited in the dam to keep the slopes from slipping and sloughing, brush had finally to be resorted to to maintain the slopes while the embankment was settling and draining. Pine and cedar boughs and young trees about 6 feet long were laid, with the butts towards the centre-line of the dam, in the low levees that were thrown up on either side of the dam. Although this gave the slopes of the dam a rough appearance, it stopped the sloughing and sliding.

During the construction a pond of water and thin mud, 1 to 5 feet deep, was maintained on top of the rising dam, and the reservoir was allowed to fill behind the dam, the water-level being kept 8 to 11 feet below the top of the dam.

For a detailed account of how the dam was repaired the reader is referred to the paper of James D. Schuyler, M. Am. Soc. C. E., mentioned above.

**The Crane Valley Dam** was constructed by the San Joaquin Electric Company in Madera County, Central California, by the hydraulic process, in order to form a storage reservoir. The dam was located in the lower end of Crane Valley, where this valley contracts into a narrow canyon, through which the North Fork River flows. The plans for the dam were prepared by J. M. Howells, M. Am. Soc. C. E., in the capacity of Consulting Engineer, and the construction was carried on under the direct supervision of the President of the Electric Company, Mr. J. J. Seymour. The general dimensions of the dam were fixed as follows:

Maximum height .....	100 feet.
Length on top.....	720 "
Width on top.....	20 "
Slope on water side.....	2:1
Width of canyon at base.....	50 "
" 60 feet higher.....	300 "

The bottom and sides of the canyon are composed of granite formation. Near the stream the rock is extremely hard, but it becomes less so as the sides recede, and near the top, on the west side, it was difficult to obtain a sufficiently firm base for the foundation of the centre core of the dam. The centre-line of the dam was excavated to bed-rock, and all loose material, boulders, and sand resting on the rock were removed on the up-stream side for a distance of about 20 feet from the centre-line. A concrete foundation-wall, 2 feet thick and 2 feet high, was then built along the centre-line. This wall was made 5 feet high in the centre of the stream-bed. About 9 inches from the up-stream side of this wall a wooden core-wall of doubled 1-inch sheeting was fastened by firmly embedding it with concrete of high grade. This sheeting was carried up about 30 feet above the bottom of the dam. Its principal object was to prevent the stratification of the material deposited by the hydraulic process from extending across the centre of the dam. After the dam was constructed it also served to prevent water from percolating through the core of the dam. According to the original plans, the wooden core-wall was to be carried up to the water-line of the reservoir, but it was found that stratification of the deposited material could be effectively prevented by a system of cutting into the plastic material in the central part of the dam by pushing down board paddles made of 1-inch boards.

When sluicing was being carried on, continuous lines of cleavage were made in the centre plastic material by means of the paddle, from end to end of the dam. These lines of cleavage were made at intervals of 2 feet on the up-stream side, from the centre-line for a distance of 20 feet, making in all 8 or 10 lines of cleavage each time the process was gone through.

In doing this work the paddles could be pushed about 10 feet into the mushy middle mass, so that the cleavage was repeated over and over again. The result obtained by this kneading process was so satisfactory that it was not considered necessary to carry the wooden sheeting higher than 30 feet from the bottom. Towards the sides of the canyon the height of the sheeting was gradually decreased until, at an elevation of 60 feet above the bottom, it extended only 6 feet above the foundation-wall, which height was maintained to the ends of the dam.

A 3-inch porous cement conduit was laid on top of the centre concrete wall, against the down-stream side of the wooden sheeting, for the whole length of the wall. This conduit was connected at the lowest point in the stream-bed with a 6-inch porous cement pipe, which was laid down the stream-bed until it extended beyond the toe of the lower slope. The object of this drainage system was to draw off any water that might percolate past the centre of the dam.

During the construction the water of the stream was carried off through a cut, 6 feet wide and 7 feet high, that was blasted out in solid rock at a level of 14 feet above the stream-bed, and was arched over with masonry. Gates were set in this culvert on the centre-line of the dam. After the completion of the dam the culvert was to be bulkheaded just above the gates, which could then be closed, allowing the water-storage to begin. A circular shaft, 22 inches in diameter, made of successive rings of cement pipe 12 inches in height, was carried up directly above the gates to the top of the dam. During the construction the water used in the sluicing, which formed a pool in the centre of the dam, was drawn off through this shaft.

The water needed for the hydraulic process was pumped from the stream by a Worthington compound duplex pump, capable of pumping 60,000 gallons per hour ( $2\frac{1}{2}$  cubic feet per second). The water was conveyed through an 11-inch riveted steel pipe to a "Little Giant" monitor, having a nozzle of  $2\frac{1}{2}$  inches diameter, which was placed at the borrow-pits, 75 to 110 feet above the stream. Flumes laid on a 6-per-cent grade carried the earth washed out of the borrow-pits to the dam. The

flumes were made of 1-inch pine lumber 12 inches wide, and had an inner cross-section 10 inches wide by 12 inches high. They were enclosed on all four sides until the dam was reached, where the top board was left off. Grades of less than 6 per cent were found to cause clogging of the flumes.

Two flumes were constructed on the dam, one on each side. They were used alternately in the sluicing operations, one side of the dam being carried up a certain height and then the other. The flumes were supported on light trestles, made of 2"×4" plank. They were raised about 10 feet in elevation each time. Slotted openings were made in the bottom of the flume, through which a dribble of water was allowed to run, that carried with it the coarser particles of sand coming down the flume. This material was shoveled out by the workmen to carry up the outer slopes of the dam. Attempts were made to carry small boulders and rock through the flumes, but this was found to be impracticable with the available quantity of water and with the grades used.

About two thirds of the total quantity of material placed in the dam was moved very cheaply by the method of pumping and sluicing described above. For the last third of the material to be placed in the dam water was brought by gravity in ditches from a distance of five miles, and the earth was ground-sluiced in, the methods of handling the sluice being similar to that of pumping.

The dam was brought up to a height of about 70 feet, which gave sufficient reservoir capacity for the needs of the company at that time. At this elevation a secure temporary spillway was obtained. Both faces of the dam were ripped with broken stone gathered from the adjoining hillsides and from the temporary spillway.

During the construction of the dam some blasting had to be done at the outlet of the culvert. This caused a break in the 3-inch drainage-pipe, described above, at the point where this pipe crossed the outlet-culvert. This led to a break in the dam, which began by showing an increase and discoloration of the small quantity of water that was carried by the 6-inch drainage-pipe to a point below the toe of the lower slope of the dam. This flow increased to 3 or 4 miner's inches of highly discolored water carrying much sand, which quantity was discharged for several days. At this time the reservoir was almost full to the spillway, with the outlet-culvert discharging its full capacity of water.

As the result of washing out of material in the dam a subsidence occurred on the top of the dam, about 40 feet from the centre, on the up-stream side and a little to one side vertically of the outlet culvert. The subsidence continued until a conical-shaped depression, 15 to 20 feet deep, had been made. Several concentric rings of fracture occurred around this crater, the outermost being nearly 60 feet from the centre of the disturbance. In order to repair the break great quantities of gravel, boulders of varying sizes, and bags of sand were thrown into the break, and were supposed to have checked the leak, as it gradually stopped.

To repair the break a shaft was sunk around the 22-inch cement pipe-shaft, through which the water had been drained off during the sluicing. Some of the sections of this pipe were found to be broken by the movement of the top of the dam towards the depression. When the top of the culvert was reached by the shaft it was found that the 3-inch drain-pipe had been plugged with roots and leaves which had been washed into the dam in the process of sluicing. This drain-pipe was plugged with cement, the circular drainage shaft was removed, its opening into the culvert being closed, and the exploration-shaft was filled up.

The reservoir has been in use since its completion, but the dam has not been brought up, at this date, to the height originally contemplated, namely, 100 feet.

**Hydraulic-fill and Rock-fill Dams on Snake River, Idaho.**—Three dams were built in 1904–1905 by the Twin Falls Land and Water Company to divert Snake River into irrigation canals, on either side of that stream, in Cassia County, Idaho. The plans for the work were prepared by W. G. Filer, Manager of the Company, and P. S. A. Brickel, Chief Engineer, with the advice of James D. Schuyler, M. Am. Soc. C. E., as Consulting Engineer.

At the site selected for the dam, the river was divided by two islands of basaltic rock into three channels. The north channel was the permanent bed of the river, the middle channel carried a considerable volume of water at medium high water, while the south channel carried water only during exceptionally high floods. The three channels were closed by earth and rock-fill dams, which raised the river 9 feet above normal low water. The islands were utilized for wasteways. The principal dimensions of the dams are:

Location.	Top Length.	Height above Lower Toe.	Volume.	
			Rock-fill.	Earth.
Main channel . . . . .	340 ft.	86 ft.	39,650 cu. yds.	58,000 cu. yds.
Middle channel . . . . .	335	81	42,800	62,850
South channel . . . . .	560	56	34,700	48,000

The total length of the three dams and the spillway is about 2,100 feet.

The rock-fill parts of the dams were made 10 feet wide at the crest, with slopes  $1\frac{1}{2}$  to 1 on the down-stream side, and  $\frac{3}{4}$  to 1 on the up-stream side. After the base of each dam had been stripped of surface soil and loose material, a trench, 5 to 6 feet wide, was excavated into the bed-rock along the centre-line of the rock-fill, extending up to the top on the sides. A continuous core-wall of double 2-inch plank was built in the trench from the bottom to within 6 feet of the top. The planks were laid horizontally, breaking joints, and were spiked to  $3'' \times 6''$  uprights, placed 2 feet apart from centre to centre. The base of this wooden core-wall was embedded in concrete, which filled the trench to above the line of the bed-rock and formed a tight bond with the rock. The loose rock-fill was built up on each side of the core-wall, which was carried up considerably in advance of the rock-filling. For several feet on each side of the core-wall the rock was carefully laid by hand, but beyond this it was loosely dumped from a cableway. The object of the core-wall was to prevent the earth sluiced against the up-stream side of the rock-fill from flowing through the voids in the rock. The earth available for the dam consisted of fine, white or grayish soil, which covers this region to a depth of from 2 to 20 feet. It is almost impalpable powder, free from grit and very uniform, which is classified by geologists as loess or æolian (wind-borne) soil. It absorbs water very slowly, but packs very solidly after becoming wet, and becomes as impervious as solid clay, without having the disadvantage of clay of shrinking and cracking as it dries. In constructing the south and middle embankments, a levee was thrown up with dry earth at the up-stream toe of the fill. The earth used for this purpose was hauled by wheel-scrappers or wagons. The bulk of the filling between the levee and the rock-fill was sluiced in place by water delivered by a centrifugal pump from the river to the earth-dump at one end of the dam. The earth required was brought by cars from borrow-pits and dumped at such an elevation, at the nearer end of the dam, that the water would carry it to the other end. Earth sluiced in this manner forms a grade of 2 to 4 per cent. All the voids on the up-stream side of the rock-fill were filled with liquid mud. Some slight leakage occurred in the wooden core-wall, but this was soon stopped by the swelling of the wood. The earth embankment was always kept about 20 feet below the top of



the rock-fill. While the earth was being sluiced-in it was so soft that a pole could easily be pushed down 10 feet or more into the mud, but after drying for four days it became so hard that a team could be driven over it without sinking in. About 1.5 cubic feet of water per second was used for sluicing the earth. It was sprayed upon the dusty earth coming from the cars, and converted it almost immediately into liquid mud. After depositing its material the water soon disappeared in some mysterious manner, without reappearing at either slope of the dam, being partly absorbed by the dry earth at the outer slope. About 80 per cent of the volume of the middle and south dams was made by the hydraulic process, only 20 per cent being put in dry at the outer slope. The dams showed no leakage when the reservoir was filled.

A somewhat different method of construction had to be employed for the north dam, which was built in the bed of the main stream, where the flow amounted to 5,000 to 10,000 cubic feet per second, during the construction. The water was diverted into a large tunnel, which was driven at the north end of the south island, next to the middle dam. When the work on the dam was begun, the water in the north channel was 20 feet deep. Two parallel fills of large, loose rock were made, by means of a cableway, across the channel, to form the outer toe-walls for the rock-fill. Sufficient room was left between these walls for sinking a line of timber cribs, 24 feet wide, placed so as to have their upper edges in line with the centre core-wall subsequently built. The bed-rock was cleaned off to receive the cribs by divers, who adjusted the cribs to their correct position. After the cribs had been loaded with stones, double 2-inch sheet-piling was laid against the upper face of the cribs and spiked thereto, the bottom of the sheet-piling being placed in a shallow trench blasted out in the rock under water. Concrete in bags was placed against the bottom of the piling so as to form a wall, about 6-8 feet wide at the base and 4 feet high. It took two divers two months to place this concrete.

After a tight core had thus been constructed in the rock-fill the hydraulic filling was begun. The earth required was dumped from wagons into a receiving-box at the end of a flume on the north side of the river, and sluiced by water pumped from the river to the dam. A centrifugal pump, having a capacity of about 1 cubic foot per second, was used for the purpose. The filling was done from the core-wall towards the up-stream toe. The material assumed the flat slope of 6 or 7 to 1 under the water-line. Some bad leaks occurred through the core-wall, possibly on account of the settling of the cribs, and caused considerable loss of material. The leaks were stopped with difficulty with fine gravel brought in a barge from a few miles above the dam. Serious trouble was encountered in making the hydraulic fill on account of the necessity of doing part of this work in winter. The earth would freeze in cold weather in layers and afterwards thaw out, causing a settling of the embankment. Since the repairs have been made the dam appears perfectly tight.

**Dam for the Waialua Sugar Plantation.**—This dam was built in 1904-1906, on the island of Oahu, 22 miles from Honolulu. James D. Schuyler, M. Am. Soc. C. E., was engaged in 1903 as Consulting Engineer on the proposed dam, and recommended that it be made a combination of rock-fill and earth-fill, with an extreme height of 98 feet and a crest width of 25 feet, 10 feet above the level of the spillway. A wooden core-wall was built in the rock-fill with its bottom embedded in a concrete wall, and the earth was to be sluiced into position against the core-wall, so as to have a slope of 4 to 1 on the water side. The dam was built practically according to these recommendations, under the direction of Mr. H. Clay Kellogg of Santa Anna, California.

The dam has a length on top of 460 feet, a top-width of 25 feet, and a width of 580 feet at

the base. The rock-fill is 11.5 feet wide at the top and 80 feet at the base. It contains 26,000 cubic yards of loose rock, a considerable portion of which was laid by hand as a dry wall. The outer slope of the rock-fill is  $\frac{3}{4}$  to 1, and the inner side is vertical. The wooden core-wall was built in the rock-fill, 2 feet down-stream from its vertical face. It consists of double 2-inch redwood plank, laid horizontally, with a double layer of bur'ap dipped in hot asphaltum between the two layers of plank, and spiked to  $3'' \times 6''$  uprights, placed 2 feet apart, centre to centre. The bottom of the core-wall was embedded in a concrete wall built in a trench, which had a maximum depth of 38 feet below the surface and extended laterally into the hillsides from 14 to 28 feet. The trench was made 5 feet wide at the bottom, and was filled with concrete to a level slightly above the natural surface. The rock (basaltic boulders) was brought in cars to the site of the dam and dumped from a high trestle.

The water required for making the hydraulic fill was delivered by pipes from an upper ditch to a point 2,000 feet distant from, and 50 feet higher than, the dam. Ground-slucing was resorted to, as the available head was not sufficient for excavating and disintegrating the material. Between the point where the water was delivered and the dam there was a large quantity of earth of great depth that was considered suitable for making the hydraulic fill. For a depth of 2 or 3 feet it consisted of reddish-brown soil, under which there was a bright-red tufa for a depth of 20 to 50 feet, and then yellow tufa for 50 to 100 feet more. This tufa resisted the erosive action of the water in a remarkable manner. It had no tendency to slide, and would stand vertically in trenches for a long time. It was found to be very difficult to sluice the tufa, as it contained no sand or grit to do the cutting and would settle in the pond very rapidly. The method resorted to for sluicing this material was to dig a ditch, about 4 feet deep at its upper end and 12 to 16 feet deep at the dam. Its length was about 1,300 feet. The earth on either side of this ditch, for a width of 12 feet, was loosened by a steam-plow and dumped by scrapers into the running water in the ditch, which had sufficient velocity to carry the earth to the dam. This was found to be the only practical way of handling the tufa, as the water had no effect when turned upon the plowed ground, and ran over it perfectly clear.

The process described above was continued until the ditch grade was reached, when a new strip would be plowed and the ditch would be shifted over to the bluff-bank on either side of its original position. The total cost of placing the earth in the dam, by the method described above, amounted to 11 cents per cubic yard. The hydraulic fill has a volume of 141,000 cubic yards. It is reported to be very hard and perfectly water-tight. The reservoir formed by the dam stores 2,500,000,000 gallons.

**The Zuñi River Dam** is being built by the United States Indian Bureau to store water for irrigating the lands of the Zuñi Indian Reservation in McKinley County, New Mexico, about 40 miles south of Gallup. The dam is being constructed under the direction of J. B. Harper, M. Am. Soc. C. E., James D. Schuyler, M. Am. Soc. C. E., being engaged as Consulting Engineer.\*

The dam, which will be 401 feet long on top and 70 feet high, is being built of a loose rock embankment, backed by an earth-fill, placed by the hydraulic method. The rock-fill consists of stones, weighing 2 to 6 tons and occasionally 8 to 10 tons, laid by hand, the spaces between these stones being carefully filled with small stone. Fig. 58 shows a cross-section of the dam. No wooden core-wall was built in this dam, the liquid earth being retained by two levees of dry

---

\* The views of this dam, given on Plate X, and the dimensions were kindly furnished to the author by J. B. Harper, M. Am. Soc. C. E.

PLATE Y.



Fig. 1.—Dumping Sluiced Material into Pond on Top of Earth-fill

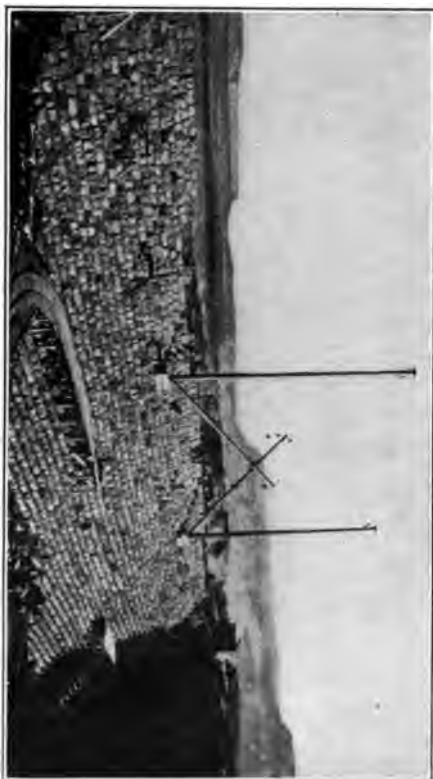


Fig. 2.—Down-stream face of Rock-fill.



Fig. 3.—Rip-rap on Up-stream Face



Fig. 4.—Monitor Cutting Bank

ZUNI RIVER ROCK-FILL DAM, NEW MEXICO.



earth, about 10 feet wide, one placed against the rock-fill and the other at the outer slope of the earth-fill. The levees were made of earth hauled by teams.

The water required for sluicing was delivered through an 8-inch pipe to a hydraulic giant by a steam-pump having a capacity of about 3 cubic feet per second. The pressure was sufficient to enable the stream to loosen the soil and to convey it through the sluice-boxes to the dam. The earth used for making the fill contains about 73 per cent of exceedingly fine sand and 27 per cent of clay.

On one side of the dam a spillway is being constructed with a wasteway 100 feet wide. Water will be drawn from the reservoir through a tunnel.

The reservoir formed by the dam will cover 623 acres and store about 5,213,000,000 gallons.

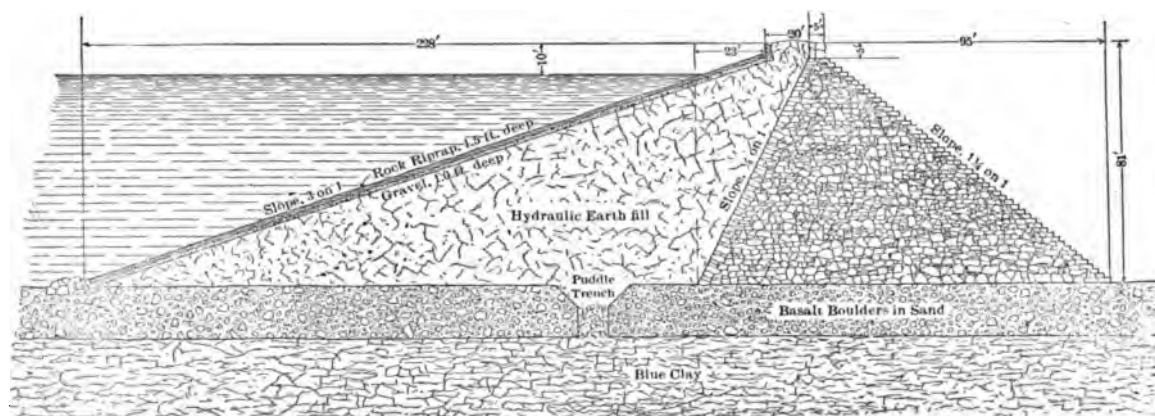


FIG. 58.—ZUNI DAM.

**The Terrace Dam** is being constructed at the head of the lower canyon of the Alamoosa River, in southeastern Colorado, to form a reservoir of spring-water for irrigation. The lower 70 feet of the dam is constructed in a narrow slit in the bed-rock, 20 to 60 feet wide, having vertical sides. Above this rock the canyon widens out, having a section like the end of an ellipse. The dam is to have ultimately a height of 180 feet above the river, or of about 110 feet above the valley proper. Its length will be 500 feet. The crest, which is to be placed 10 feet above the water-line, is to have a width of 20 feet. The up-stream and down-stream slopes are to be, respectively, 3 to 1 and 2 to 1.

The dam is being built by the hydraulic method, the water required being obtained from the Alamoosa River, at a point above the reservoir at sufficient elevation to deliver the water about 200 feet higher than the top of the dam. It is conveyed to the dam through a ditch and flume, five miles long.

In the lower 70 feet of the dam, in the narrow canyon mentioned above, a core-wall of concrete, 15 feet thick, was built on the centre-line of the dam. It was curved on a radius of 50 feet. Two parallel walls, placed 25 feet apart, were built in trenches, cut in the bed-rock, on each slope to the high-water line, and connected with the core-wall in the centre of the valley. These walls were carried up 2 to 3 feet above the natural surface, and were covered by the sluiced earth. They serve to intercept seepage along the surface of the bed-rock.

The method of building the dam by hydraulic sluicing was first suggested by T. W. Jaycox, M. Am. Soc. C. E., State Engineer of Colorado. E. W. Case, of Colorado Springs, was in charge of the construction; and James D. Schuyler, M. Am. Soc. C. E., acted as Consulting Engineer.

**Hydraulic-fill Dams in Mexico.**—The Mexican Light and Power Company, Limited, a corporation that supplies light and power to the city of Mexico and some surrounding towns, is constructing four dams by the hydraulic process on two parallel rivers, the Necaxa and Tenango,



FIG. 59.—DAM NO. 1, TENANGO RIVER.  
Distributing Sluiced Materials through Pipes.

about 100 miles northeast of the city of Mexico. The works are being constructed under the general management of F. S. Pearson, M. Am. Soc. C. E., who is the Vice-President and Con-



FIG. 60.—DAM NO. 1, TENANGO RIVER.  
Depositing Liquid Earth through Pipes on Down-stream Slope.

sulting Engineer of the Company, James D. Schuyler, M. Am. Soc. C. E., being retained as Consulting Engineer. Albert Carr, M. Am. Soc. C. E., has charge of the work as Manager of Construction, and F. S. Hyde is the Resident Hydraulic Engineer.

Dam No. 1 is a low barrier, about 30 feet high, which is being built on the Tenango River. It will divert water through a tunnel 3,000 feet long into the Necaxa River, immediately below the dam known as No. 3. Figs. 59 and 60\* illustrate how the earth is placed in this dam by the hydraulic method.

Dam No. 2 (Fig. 61), which is being constructed on the Necaxa River, will have a volume of 1,993,700 cubic yards. Its principal dimensions will be:

	Feet.
Length on top . . . . .	1,220
Top-width . . . . .	54
Base, measured along stream-bed . . . . .	975
Height above lower toe . . . . .	190
“ “ upper toe . . . . .	178
Down-stream slope . . . . .	2 to 1
Up-stream slope . . . . .	3 to 1

The dam is being built of broken limestone and yellow clay, which are found intermingled in about equal proportions at a convenient distance and elevation. The rock is delivered at the outer parts of the dam and the clay in the centre.

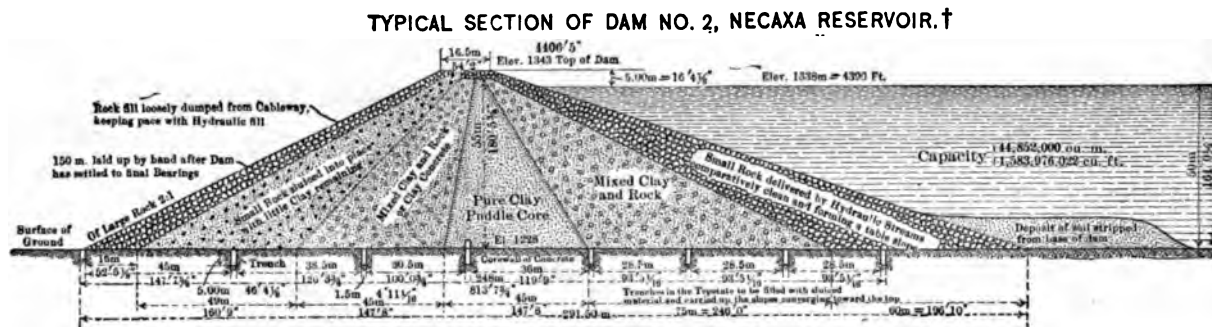


FIG. 61.

Dam No. 3, on the Necaxa River, is located about 6 miles up-stream from Dam No. 2. It will have a maximum height of 175 feet. The water required for sluicing is brought in a ditch having a capacity of about 123 cubic feet per second, 70 cubic feet per second of this quantity being delivered at Dam No. 3 and the remainder at Dam No. 2, with a head of 728 feet above the base of the dam.

Dam No. 4 is being constructed near the head-waters of the Necaxa River, at a place called Laguna. The dam will be about 2,880 feet long on top, and will have a maximum height of about 80 feet.

**Dam in Brazil.**—A hydraulic-fill dam is being constructed by the São Tramway, Light, and Power Company, Limited, on the Tieti River, in the State of São Paulo. According to the plans prepared by James D. Schuyler, the Consulting Engineer of the Company, the dam will be 40 to 45 feet high and about 2,000 feet long. The work is being constructed under the direction of Mr. M. M. Murtaugh.

\* Figs. 59 and 60 are taken from a paper on "Recent Practice in Hydraulic-fill Dam Construction," by James D. Schuyler, M. Am. Soc. C. E., published in Proceedings Am. Soc. C. E., October, 1906.  
 † This figure is taken from "The Necaxa Plant of the Mexican Light and Power Company," by F. S. Pearson and F. O. Blackwell, Members Am. Soc. C. E. See Proceedings Am. Soc. C. E., October, 1906.

## CHAPTER III.

## ROCK-FILL DAMS.

WITHIN recent years a new style of dam has come into use in the Western States of the Union. We refer to what is known as a rock-fill dam, an embankment consisting of rock dumped loosely except at the faces, where it is laid carefully as dry slope-walls. Water-tightness is insured by a sheeting of boards or a facing of concrete on the water-slope, or by building an earthen dam against the inner or outer slope.

Rock-fill dams were first introduced for storing water for placer-mining, and have since been used for impounding water for irrigation. In mountainous regions, where the cost of transportation limits the use of cement, rock-fill dams will cost less than masonry dams. If placed upon an unyielding foundation (rock or hard-pan) and properly constructed, such a dam has ample strength. It will not be as tight as a dam of masonry, but the leakage can cause no damage. Where cement can be obtained at a reasonable cost, a masonry dam will generally be found to be cheaper than a rock-fill, as it has a much smaller cross-section. Under ordinary circumstances a rock-fill dam would be more expensive to construct than one of earth. Local circumstances may, however, change these conditions, and the fact that several high rock-fill dams have been built of late in the mountains of Western States leads to the inference that the engineers who designed the works found this style of dam to be the cheapest they could construct.

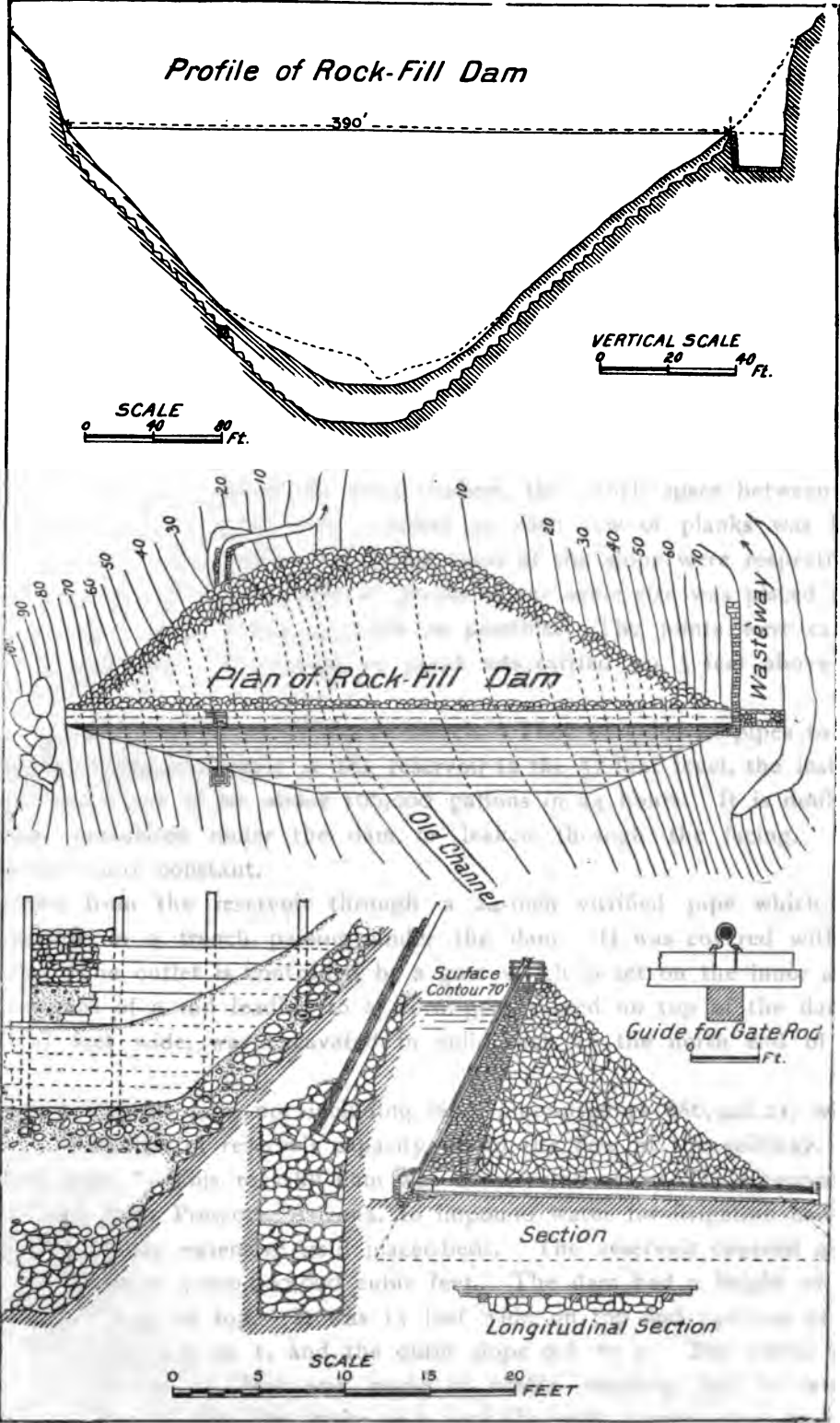
The various ways in which rock-fill dams can be built will be best illustrated by describing the construction of a number of such works. We have obtained most of the information given about these dams, from the very valuable report on "Reservoirs for Irrigation" by Mr. James D. Schuyler, M. Am. Soc. C. E., which was published in Part IV of the Eighteenth Annual Report (1896-97) of the United States Geological Survey.\* Some information on the subject is also given by Mr. Herbert M. Wilson, C.E., in his "Manual of Irrigation Engineering." Short accounts of some of these dams have also appeared in the engineering papers.

The **Escondido Dam** was the first rock-fill dam built in California to form a reservoir for irrigation purposes. It is 76 feet high, 140 feet wide at the base, and 10 feet on top. The dam is 380 feet long on its crest and 100 feet long at the river-bed. The slope on the water side is  $\frac{1}{2}$  to 1. On the other face the slope is 1 to 1 for the upper half and  $1\frac{1}{2}$  to 1 for the lower half. The dam consists of a fill of loose rock in large blocks weighing up to 4 tons. No quarry-spalls or earth were used in the fill. On the inner face the stones were carefully laid by hand to form a dry wall which is 15 feet thick at the bottom and 5 feet on top. The dam contains 37,159 cubic yards of rock, of which 6000 cubic yards were laid as dry wall. All the

---

\* For fuller accounts see Schuyler's "Reservoirs for Irrigation," etc.





ESCONDIDO DAM.  
(From "Eighteenth Annual Report of U. S. Geological Survey.")



stone used was obtained from boulders or outcropping ledges of rock, as no good quarry could be found near the work. It was transported on tramways and dumped from cars into the rock-fill, being only roughly placed by means of derricks. A trestle was built on the longitudinal centre-line of the dam to support the tramway. It was raised as the work required, the posts being left in the fill.

Before the dam was begun the whole space it was to occupy was stripped of soil, rock being uncovered at a depth of about 4 feet below the river-bed, extending almost level across the valley. As the bed-rock was found to consist of disintegrated granite holding boulders, a trench was excavated at the upper toe of the dam 3 to 12 feet deep into the bed-rock. A wall 5 feet thick, made of rubble laid in cement mortar, was built in this trench to prevent leakage under the dam and to serve as the foundation of a facing of planking which was placed against the up-stream face. Redwood timbers, 6 × 6 inches, were placed vertically in the dry rubble wall of this face, 5 feet 4 inches apart. They were embedded in the rubble 4 inches deep and projected 2 inches. Horizontal planks were spiked to these timbers, the 2-inch space between the dry wall and the planks being filled with concrete as each row of planks was laid. The planks used for the lower, middle, and upper third of the slope were respectively 3, 2, and 1½ inches thick. A second layer of planks of the same size was placed over the first one, the joints being broken as much as possible. The joints were caulked and smeared with asphaltum. The facing of plank was carried up 3 feet above the top of the dam.

Springs were encountered in the foundation-trench. They were led in pipes to the outer toe. When the water was raised in the reservoir to the 57-foot level, the leakage from the reservoir was found to be about 100,000 gallons in 24 hours. It is doubtful whether this water percolated under the dam or leaked through the facing. The leakage has remained quite constant.

Water is drawn from the reservoir through a 24-inch vitrified pipe which was embedded in concrete in a trench passing under the dam. It was covered with 12 inches of concrete. The outlet is controlled by a gate which is set on the inner slope and operated by means of a rod leading to a worm-gear placed on top of the dam.

A spillway, 25 feet wide, was excavated in solid rock at the north end of the dam.

The cost of the rock-fill dam, not including land, amounted to \$86,946.21, which is about \$27.82 per acre-foot of reservoir capacity up to the flow of the spillway.

**Walnut Grove Dam.\***—This rock-fill dam was constructed across the Hassayampa River, about 30 miles from Prescott, Arizona, to impound water for irrigation and for furnishing power for working extensive gold placer-beds. The reservoir covered about 1000 acres and stored about 3,000,000,000 cubic feet. The dam had a height of 110 feet, and was 400 feet long on top. It was 15 feet wide on top and 140 feet at the base, the water-slope being 0.5 to 1, and the outer slope 0.6 to 1. The entire base of the dam for a height of 10 feet was made of rubble masonry laid in cement mortar. Above the base the dam was made as a rock-fill, with granite stone quarried

---

\*Engineering News for 1888.

near by and dumped from cars that were carried across the valley on a timber trestle built on the longitudinal axis of the dam. The trestle was raised as the work progressed, the posts being left in the fill. At the slopes, the stone was laid by hand so as to form dry face-walls.

Water-tightness was obtained by a facing of planking. Cedar logs were embedded vertically in the inner face-wall, about 6 feet apart. Longitudinal timbers, 8 × 8 inches, were notched and bolted to the cedar logs, about 3 feet apart. A sheathing of 3 × 8-inch planks, placed vertically, was spiked to the longitudinal timbers. This sheathing was covered with prepared tar-paper, about  $\frac{1}{8}$  inch thick, which was secured by a horizontal sheathing of 3 × 8-inch plank. All the joints of the planks were carefully calked. The outer sheathing was coated with pitch and then with paraffine paint.

The outlet gate-house was built of timber and is 6 feet square in section. It was provided with gates for controlling two 20-inch outlet-pipes that pass through the base of the dam and were embedded in masonry.

A waste-weir, 6 by 26 feet, was blasted out of the rock on one side of the dam.

About 50,000 cubic yards of stone were required to make the dam. In addition to this about 12,000 cubic yards more from the waste-weir and channel were dumped in front of the dam.

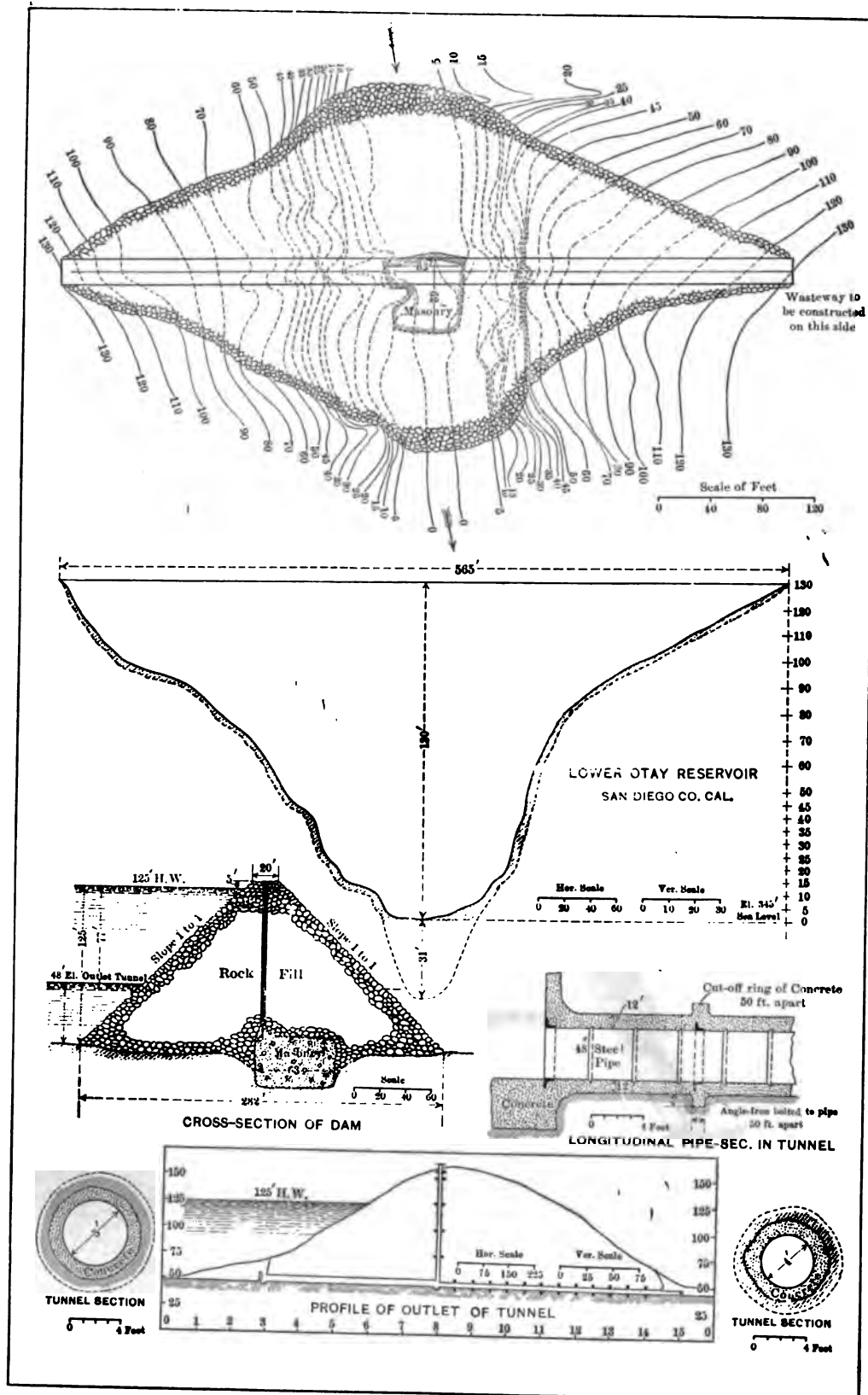
The plans for the work were made by Prof. Wm. P. Blake, the well-known mining expert, but the execution of the work was left principally in the hands of the contractors and projector of the enterprise. The dam leaked considerably when the reservoir was first filled, but gradually became more water-tight. In February, 1890, however, the dam was completely destroyed during a great flood. This failure is ascribed to the insufficiency of the wasteway, which could not discharge the flood-water, and to carelessness in the execution of the work.

**Lower Otay Dam.**—This rock-fill dam was constructed on Otay Creek, about 20 miles southeast of San Diego, California, to form a reservoir for irrigation purposes and also for furnishing a domestic supply for Coronada Beach. The dam, which is 130 feet high, consists simply of a loose rock-fill, none of the stones being placed by hand. It is 20 feet wide on top, and both slopes are made 1 to 1. Water-tightness is insured by placing a core of steel plates in the centre of the fill, forming a web-plate across the canyon.

The original plans for the reservoir contemplated the construction of a masonry dam. The foundation for the wall was actually laid 63 feet wide and carried up about 40 feet high. This block of masonry was used as the foundation for the steel web, which was placed 6 feet from the up-stream face of the masonry. The bottom plates were 5 feet wide and 17.5 feet long. Above a height of 50 feet plates 8 feet wide by 20 feet long were used. In the lower three courses the plates are 0.33 inch thick. All the others have a thickness of  $\frac{1}{4}$  inch.

The plates were riveted together in position and calked. They were coated with hot asphalt, and covered on both sides with burlap which had been saturated with asphalt. To stiffen and protect the plate against the rock dumped around it, a masonry wall was built on each side against the plate. Each of these walls is 6 feet thick

PLATE AA.



LOWER OTAY DAM.



at the base and tapers to a thickness of 1 foot at a height of 8 feet, above which the walls are uniformly 1 foot thick. At the sides of the valley the plates were placed in trenches cut in the solid rock, securely anchored and protected by masonry. As might have been imagined, considerable difficulty was experienced in keeping the plates in line on account of expansion and contraction due to changes in temperature.

The stone required for the dam was all quarried below the work, brought to the fill by a Lidgerwood cableway, and distributed by means of derricks. The largest stones were placed on the down-stream side of the plate-core, smaller stones and earth being used on the up-stream side. The dam contains about 140,000 cubic yards of rock.

No pipes pass through the dam. The outlet is made through a tunnel 150 feet long. For the first 500 feet from the reservoir the tunnel is lined with 12 to 18 inches of concrete, so as to form a circular conduit having an inner diameter of 5 feet. At the end of this conduit a shaft 104 feet high reaches the surface, and serves for operating, by means of rods, a sluice-gate, which controls the outlet. Beyond the shaft a 48-inch steel pipe was placed in the tunnel and surrounded with about 1 foot of concrete, collars being carried to the side of the tunnel every 25 feet.

The overflow was made in a depression several hundred feet away from the dam. The watershed above the reservoir contains about 100 square miles.

The Chatsworth Park Dam was constructed in 1895-1896, in the San Fernando Valley, California, to impound water for irrigation. It was a rock-fill dam about 41

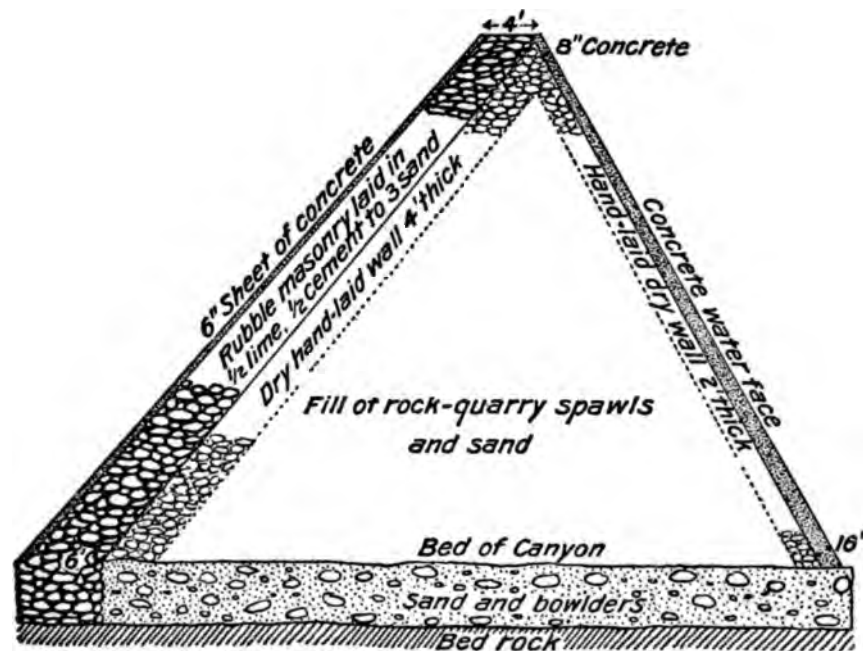


FIG. 62.—SKETCH OF RECONSTRUCTION OF CHATSWORTH PARK ROCK-FILL DAM.

feet high, 10 feet wide on top, both slopes being at an angle of  $60^\circ$  (1 vertical in 0.57 horizontal). The length was 159 feet on top and 100 feet at the bottom. On the slopes, the stones were laid to form dry walls, 2 feet thick. The slope wall on

the water side, which contained 7700 square feet, was covered with Portland-cement concrete 8 to 16 inches thick.

The dam was made with soft sandstone which was quarried near by. The work appears to have been executed in a careless manner. With a depth of only 10 feet of water in the reservoir the dam leaked so badly that the company for which it was constructed decided to rebuild the dam. The plan adopted for the new dam is shown in Fig. 62 on page 273.

**Pecos Valley Dams, New Mexico.**—Two rock-fill dams, differing from those already described, were built in the Pecos Valley, about 15 miles above the town of Eddy. In these dams leakage was stopped very successfully by forming the up-stream part of the dam of earth.

Fig. 63 shows a section of the lower dam which has a length of 1135 feet. The dam was built in 1889–1890. Owing to the insufficiency of the spillway water flowed

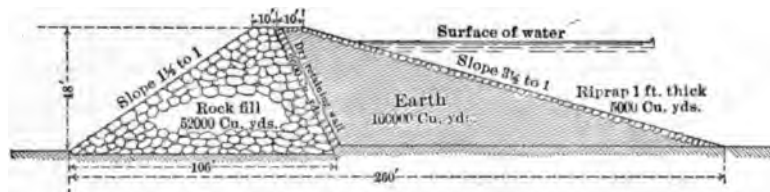


FIG. 63.—PECOS VALLEY DAM. NO. 1.

over the top of the dam, in August, 1893, and washed out a breach of over 300 feet. The damage done was repaired and the dam was raised 5 feet higher. The width of the spillway was increased from 200 to 240 feet and it was cut to a depth of 15 feet below the crest.

The upper dam (Fig. 64), which is 1686 feet long on top, was constructed in 1893 like the lower one, excepting that the rock-fill part was made 4 feet wider on top and

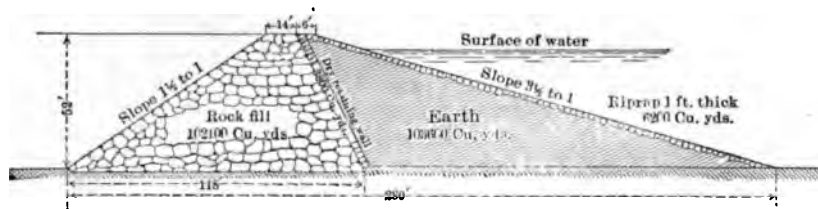


FIG. 64.—PECOS VALLEY DAM. NO. 2.

the earthen part 4 feet less, the whole top-width remaining 20 feet. The inner slope of the rock-fill, against which the earth bears, was laid up by hand as a dry stone wall 2 feet thick. The dam cost \$170,000.

The type of rock-fill dam described above appears to be perfectly safe if an ample waste-weir be provided.

**The Idaho Dam\*** was built across the Boise River at the head of the Idaho Mining and Irrigation Company's canal. It is 220 feet long on top and 43 feet high, and is made of loose rock except the facing of earth, which is 3 feet thick at the top of the

\* "Manual of Irrigation Engineering," by Herbert M. Wilson, C.E.



dam and 20 feet thick at the bottom. The dam is 10 feet wide on top. The outer rock-slope and inner earth-slope are both  $1\frac{1}{2}$  to 1.

**The Castlewood Dam,\*** Fig. 65, was built across Cherry Creek, about 35 miles south of Denver, Colorado, to store water for irrigation. This stream is liable to great changes of flow. Ordinarily its volume is very small, but during sudden freshets, following so-called cloud-bursts, it discharges as much as 10,000 cubic feet per second.

The dam was begun in December, 1889, and completed in November, 1890. It is 600 feet long on top and 8 feet wide. Its maximum height is about 70 feet above the surface and 92 feet above the foundation. This dam differs from all the other rock-fill dams we have described, in having a facing of rubble laid in cement mortar at its inner and outer slopes. Between the face-walls the dam consists entirely of loose stone dumped on the natural surface.

The inner face-wall is 4 feet thick and is carried up on a batter of 1 foot horizontal to 10 feet vertical, except at the highest part of the wall at the overflow, which is placed in the middle of the dam, where the inner wall for a stretch of 120 feet was made vertical on the side next to the rock-fill. The foundation-trench for the inner wall was excavated in an arenaceous clay, containing large boulders, to a depth of 6 to 22 feet.

The outer face-wall is carried up in steps on a general slope of 1 to 1. Its foundation is nowhere more than 10 feet below the surface. The steps were formed of dimension-stone, which extend at least 3 feet into the dam. Both the inner and outer face-walls rest on footing courses of concrete 1 to 2 feet thick.

The face-walls are carried up on the slopes mentioned to the elevation of the spillway, where they are united. The top of the dam is formed of a wall of rubble masonry, 8 feet wide and 4 feet high, having vertical faces.

The overflow, which is placed in the middle of the dam, is 100 feet long by 4 feet deep. In addition to this a by-pass 40 feet wide is provided on the west side of the dam, and aids in discharging the surplus water. Its floor and sides are lined with masonry to a safe point of discharge.

The outlet-well is built in the centre of the dam adjoining the overflow-weir. It measures, on the inside,  $6 \times 7\frac{1}{2}$  feet. The walls of the well are 4 feet thick, except towards the reservoir, where the thickness of the wall is increased by offsets to 10 feet at the surface. As these offsets are made on the inside of the well, to provide a foundation for the valves controlling the inlet-pipes, the opposite wall is recessed out to maintain the inner dimension of the well. Where the recesses are made, the wall is supported by arches. Eight 12-inch inlet pipes, placed in pairs at four different elevations, admit the water to the well, from which it is conveyed by a 36-inch concrete conduit and discharged into the creek a short distance below the dam.

The Castlewood Reservoir covers 200 acres of land and stores about 4,000,000,000 U. S. gallons. It was built for the Denver Land and Water Company according to the plans prepared by their Chief Engineer, Mr. A. M. Welles. The plans contemplated

---

\*Engineering Record, Dec. 24, 1898, and Engineering News, Feb. 9, 1899.

placing an earthen slope against the inner face of the dam to a certain height. This was not done, however, until later, after the dam commenced to leak badly. The contract for the work was given to the Rosenfeld Construction Co., who employed their own

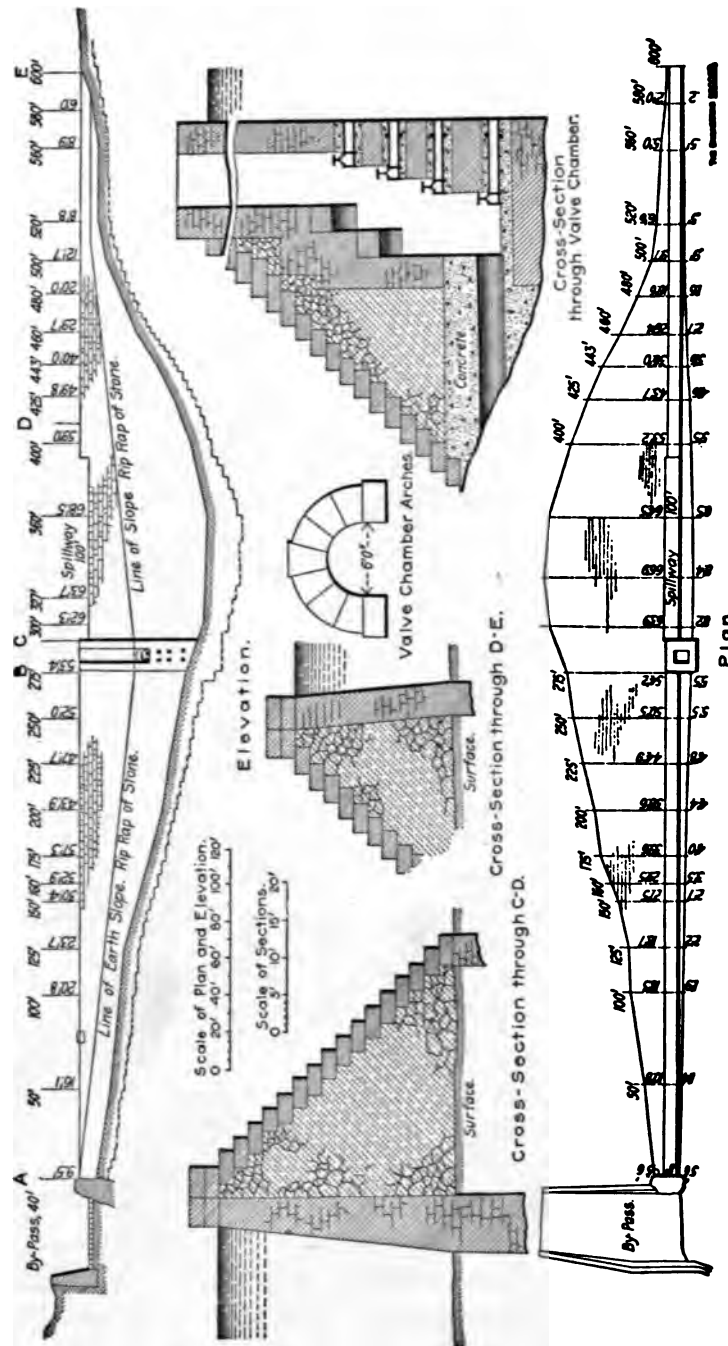


FIG. 65.—THE CASTLEWOOD DAM. (By permission of "The Engineering Record.")

engineers. Although the Denver Land and Water Co. had inspectors on the ground, the work appears not to have been well executed in some particulars. Settling occurred at some points, causing cracks 2 to 4 inches deep, through which the water found an outlet. At one point the water appears, also, to have flowed under the dam.

The dam was repaired and an earthen slope placed at its up-stream face. The top of this bank is 35 feet below the crest of the dam at the centre and rises gradually so as to reach the crest at both ends of the dam. This slope is covered by a rip-rap 1 foot thick. Where the leakage occurred clay puddle was placed next to the inner wall.

The plans of the Castlewood Dam have been severely criticised, especially the fact that the inner face-wall, where only 4 feet thick, overhangs the loose rock-fill, its centre of gravity falling outside its base. Eight years of service have, however, not yet shown any disadvantage resulting from this feature. Engineers will be interested in watching the future history of this dam.

**The Morena Rock-fill Dam** was constructed by the Southern California Mountain Water Company, about 50 miles east of San Diego. It is a rock-fill placed in a narrow canyon, which is filled throughout with enormous boulders. At the stream-bed the canyon is 80 feet wide. Its sides have a slope of about 1:1 for a height of about 500 feet. A narrow fissure was discovered at the site of the dam that had been eroded by the stream to a depth of more than 100 feet below the stream-bed. A masonry toe-wall was built from the bottom of this fissure to the stream-bed, a height of 112.5 feet. This wall is 36 feet thick at the bottom, where the width between the solid sides of the fissure was but 4 feet for a height of 12 feet. The greatest width of the fissure was 16 feet. At the zero contour the masonry wall was made 20 feet thick, and it was carried up 30 feet higher, its thickness at the top being 12 feet.

According to the original plans, the dam was to have a maximum height of 160 feet and to form a reservoir capable of storing about 15,000,000,000 gallons. The work was begun in July 1896, but was temporarily suspended in 1897, after the dam had been brought up to a height of about 100 feet, on account of litigation over water-bonds issued by the City of San Diego.

In building the dam the rock on either side of the canyon was loosened by large blasts, and boulders weighing hundreds of tons were deposited in this manner in the bed of the canyon and on its slope.

The reservoir is supplied by a watershed of 130 square miles, and the water is drawn from the reservoir through a tunnel 8' x 8' in section and 600 feet long.

**The East Canyon Creek Dam, Utah,\*** was constructed in 1898 and 1899 on the East Canyon Creek to form a reservoir of about 1,862,000,000 gallons capacity for irrigation. The canyon in which the dam is built is only 54 feet wide at the creek-bed. The dam was originally built to a height of 68 feet above the creek-bed and had a length of 100 feet on the crest. It was subsequently raised 25 feet.

Before the construction of the dam was begun, a temporary dam was built about 1,000 feet above the site of the dam, and the creek was diverted in a canal along the hillside, with a flume in the canyon, to a point below the site of the dam. A trench, 15 feet wide, was then excavated across the canyon to solid rock, which was encountered at a maximum depth of 35 feet below the surface. Soundings showed that this rock was near the edge of what had once been a cataract. Thirty feet down-stream from the trench

---

\* *Engineering News*, January 2, 1902, and *Engineering Record* of 1901.

the soundings failed to reach rock. This discovery led to the decision to build a loose rock-fill with a steel core. The rock in the trench, which was very smooth, was roughened by blasting and the trench was filled with concrete to form a cut-off wall. This part of the work was completed in March 1898, and in the following August a contract for building the rock-fill dam was given to Perham Brothers and Parker of Butte City, Montana.

The bulk of the loose rock-fill was made by blasting into the fill rocks from the sides of the canyon, which rose to a height of about 100 feet. Some of these rocks contained over 100 cubic yards. After the rock-fill had been made to a sufficient extent a trench was excavated in it down to the concrete wall, and the steel core with a protection on each side was constructed in the following manner:

The core was made of three tiers of plates which were riveted together and calked. In the bottom tier the plates are 20 feet high, 5 feet wide, and  $\frac{3}{8}$  inch thick; in the middle tier they are 20 feet high, 5 feet wide, and  $\frac{1}{4}$  inch thick, and in the top tier they are 28 feet high, 5 feet wide, and  $\frac{1}{4}$  inch thick. The plates were covered with two coats of refined asphalt.

The foot of the bottom tier of plates was riveted between 2 angle-bars ( $3 \times 4\frac{1}{2} \times \frac{1}{4}$  inches) and rests on the concrete foundation. This arrangement was carried across the canyon and extended into trenches blasted into the rock at the sides of the canyon. On each side of the steel core 4 inches of asphalt concrete was placed, which was increased to a thickness of 4 feet at the ends to secure tight joints with the sides of the canyon.

The bottom of the steel core was embedded in concrete for a height of 5 feet. On each side of the steel core, next to the asphalt concrete, the stones of the rock-fill were laid carefully by hand, forming walls 20 feet thick at the base and 10 feet at the top. For the remaining parts the fill was formed by blasting rocks from the walls of the canyon, as described above, except on the up-stream and down-stream slopes, where the stones were laid by hand to a depth of 5 feet. The former slope is 1:1, while the latter is 2:1.

An outlet tunnel, 190 feet long, having an oval cross-section 6 feet high and 5 feet wide, was excavated at a point about 70 feet to the right of the north end of the dam. About 130 feet from the upper portal of this tunnel a shaft, 8 by 8 feet in cross-section, was excavated to the floor of the tunnel.

Two 30-inch outlet pipes were laid in this tunnel, which was filled with concrete laid around the pipes. For a certain distance from the reservoir the outlet pipes were made of riveted steel and for the remaining length cast-iron pipes were laid.

Each pipe-line was provided at the shaft with a valve which can be operated from the top of the shaft, and, in addition to this, an emergency valve operated from a platform on the side of the cliff was placed in the reservoir at the inlet of the pipe-line.

The spillway of the reservoir consists of a wooden flume 30 feet wide by  $6\frac{1}{2}$  feet deep, which discharges below the toe of the dam.

The dam was constructed by the Davis and Weber Counties Canal Company, of which W. M. Bostaph was Chief Engineer and Prof. Samuel Fortier, Consulting Engineer.

**The Pike's Peak Power Company's Dam,\*** Colorado, consists of a rock-fill faced on the water-side with steel plates. The dam is 405 feet long on top and 220 feet at the

---

\* *Engineering News*, January 1, 1903.

bottom. Its width is 20 feet at the top and 148 feet at the base, the height from bed-rock to the crest being 70 feet. The slopes of the up-stream and down-stream faces are respectively  $30^\circ$  and  $50^\circ$  from a vertical plane.

The up-stream face is made water-tight by a covering of 5'×15' steel plates. For the first eight plates from the bottom the thickness of the steel is  $\frac{1}{2}$  inch, which is then reduced to  $\frac{3}{8}$  inch and finally at the top to  $\frac{1}{4}$  inch. The plates are riveted together horizontally with butt straps and vertically by 4×5× $\frac{1}{2}$ -inch angle-bars, placed 15 feet from center to center. The 5-inch leg of each pair of angle-bars forms a joint projecting into the reservoir. The angle-bars are riveted together at their outer extremities, an iron filler  $\frac{3}{8}$ ×2 inches being placed between them. The expansion of the steel facing is taken up by the bending and spring of these legs, the distance between the plate and the filler being about 4 inches. The plates are riveted and calked as thoroughly as in boiler work. The bottom- and end-plates are embedded in concrete which is laid in a trench cut in the bed-rock. A pair of 5×8-inch angle-bars is riveted at the base and another pair is placed a foot higher. Concrete is laid around these angle-irons and acts both as a support for the entire steel face and is cut off for water. The ends are arranged in a similar manner except that the angle-bars are placed vertically. Next to the facing fine stone and sedimentary material are filled in for a space of 4 to 6 inches, enough water being used to pack the filling thoroughly. Next to this comes loose rock-fill. At the dirt filling the stones were laid by hand, but others are dumped in, enough small pieces being used to fill the spaces between the larger stones.

A spillway, 50 feet wide, cut through the rock foundation, is provided at the west end of the dam. The concrete floor of the spillway is 3 feet below the crest of rock-fill. By means of flashboards the spillway can be raised to the crest of the dam. The water is drawn from the reservoir by means of a 30-inch wooden-stave pipe which passes through the dam and extends 240 feet into the reservoir. This pipe is enclosed by concrete where it passes through the dam and it is supported in the reservoir by a rock wall to which it is anchored by steel cables.

The dam and reservoir were constructed in 1900-01 by the Pike's Peak Power Company of Victor, Colorado, under the direction of their engineer and superintendent, Mr. R. M. Jones.

## CHAPTER IV.

## TIMBER DAMS.

**General Requirements.**—Dams of brushwood, logs, cribwork, or framed timber are often built across streams to obtain water-power, to secure sufficient depth for slack-water navigation, or to divert water for irrigation. These dams are usually made strong enough to pass the streams over their crests in times of flood. They must also be able to withstand shocks from floating bodies such as ice, etc. This last requirement determines the form of the up-stream side of the dam, which should be an inclined plane (Fig. 66), in order to facilitate the passage of floating bodies and to protect the dam against shocks.

Dams have been built according to this simple profile, but unless the height of the dam be very inconsiderable the falling water will gradually undermine the dam in front, even if the bed of the river be rock and a pool of water protect it. Trautwine\* states that at the Jones's Dam on Cape Fear River, which had a height of 16 feet, the water falling vertically over the dam, usually from a height of 10 feet, into a pool of water 6 feet deep, wore out the soft shale rock (in vertical strata) on which the dam was founded for 16 feet, and undermined the dam in a few years to such an extent that it fell into the cavity.

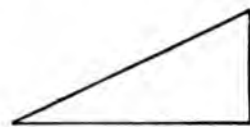


FIG. 66.

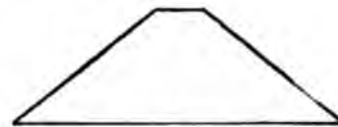


FIG. 67.

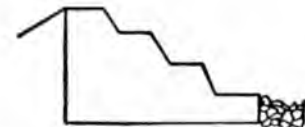


FIG. 68.

He mentions another case, where water falling vertically from a dam 36 feet high into a pool of water only 2 feet deep wore out the hard slate rock in the river 10 to 20 feet in twenty years, the erosive action extending from the face of the dam for a distance of from 70 to 80 feet.

The Holyoke Dam (page 290) is another example of the undermining of a dam by the erosive action of water flowing over it.

There are two ways of breaking the fall of the water flowing over the dam:

- 1st. By giving the down-stream side of the dam a slope (Fig. 67).
- 2d. By forming this face by a number of steps (Fig. 68). The latter plan is the better of the two, as the velocity of the water flowing down an incline plane is accelerated.

Whichever of the types shown in Figs. 66, 67, and 68 be adopted, an apron should be constructed in front of the dam to protect the river-bed against the erosive action of the overflowing water. The apron may consist simply of a layer of large stones and boulders. If the river be liable to severe freshets, the stones forming the apron must be kept in place by building a crib-dam or driving piles on the down-stream side of the layer. The whole

\* Civil Engineers' Pocket Book, by John C. Trautwine.

apron may consist of crib-work filled with dry stones. Very frequently it is formed of a course of heavy timbers (10–14 inches thick) placed closely together.

The distance to which the apron should extend down-stream depends upon the height of the dam and the greatest depth of the sheet of water that may pass over it. Under ordinary circumstances the length of the apron, measured down-stream, should be about twice the height of the vertical fall of the water.

For dams founded on rock the apron is sometimes omitted, but this should only be done under the most favorable circumstances, viz., with hard rock covered by a pool of water having sufficient depth.

Timber dams may be built, in plan, either straight or curved so as to be convex up-stream. When a straight plan is adopted the axis of the dam may either be at right angles or oblique to the current. The latter plan is sometimes adopted with a view of obtaining a longer crest for the dam, but it has the disadvantage of tending to force the current towards the bank of the river on which the upper end of the dam abuts. Instead of curving the plan of the dam, it may be pointed up-stream, especially in the case of a narrow river.

Leakage may occur through the dam, around its ends, or under it. The up-stream face should be made as water-tight as possible. Some leakage will occur when the dam has just been completed. The silt and mud borne by the stream will soon diminish this loss. While it is important to prevent the water from leaking through the dam, it is rather an advantage, after the water has passed the crest of the dam, to have enough leakage take place to keep the timbers forming the structure always wet. For this purpose the planks which are used to cover the top and down-stream slope are often placed a little distance apart.

Leakage around the end of the dam is to be prevented by carrying the ends into the banks and building against them substantial abutments which should be raised to a height which will prevent their being overflowed. For an important dam the abutments should be built of solid masonry. A cheaper construction consists in forming the abutments of crib-work filled with stones or simply of sheet-piling.

The most dangerous leakage is that which may occur under the dam, as it would undermine the structure. The surest method of preventing this leakage is to give the dam considerable width up and down stream. As a general rule a timber dam should be wider than high. The greater the width can be made the better it will be.

In a river having a soft bottom one or two rows of sheet-piles (2–4 inches thick) should be driven at the up-stream toe of the dam. It is sometimes advisable to drive sheet-piles, also, at the down-stream end of the apron.

Having considered the general requirements which a timber dam built across a stream should fulfil, we will next consider the different manners in which wood can be used in the construction of a dam.\*

**Brushwood Dams.**—In the case of a sluggish stream, having a soft bottom, a substantial dam can be formed of alternate courses of brushwood and gravel. Wood of all sizes, including saplings and even trees, should be used, the latter being always placed with their branches up-stream. After a course of brushwood 3 to 5 feet thick has been placed in position it is sunk by filling stone and gravelly earth upon it. Clay should be used but sparingly and with other earth, as it is apt to wash away.

---

\* The descriptions of the simple types of dams given on pages 282 to 288 have been taken principally from *Leffel's Construction of Mill-Dams*.

The dam is carried up by alternate courses of wood and gravel so as to have a trapezoidal cross-section. It is finished by facing the slopes with planking, fascines, or a covering of riprap.

**Log-dams.**—Where timber can be obtained cheaply an excellent dam can be built, at a very moderate cost, of logs and brush, as shown in Fig. 69. The logs should be 8 to 12 inches in diameter at the butt end. The branches should be cut off the two sides of each log, which will be its top and bottom when placed in the dam. All the logs are placed with their tops up-stream.

The largest logs are laid side by side across the stream to form the foundation course. The second and third courses of logs are stepped up-stream respectively about 25



FIG. 69.

and 20 feet. The fourth course is stepped back about 5 feet from the third course, and the dam proper is then carried up with logs, so as to have its down-stream face almost vertical. Saplings, brush, stone, and earth are placed between the succeeding courses of logs to make the dam as tight as possible. Binders, 3 to 4 inches in diameter, should be placed across the logs of all the courses of the dam proper, and should be fastened by treenails or spikes to the logs. The top course should have several binders and should be covered with stone and earth so as to have a uniform slope.

A log-dam is especially suited for soft or sandy river bottoms. Owing to its great width and ample apron it will not be undermined. It will pass severe floods without damage, as the logs, brush, and filling are strongly interlocked. Experience shows that such a dam may settle one or two feet during the first year, but after that period the settling will be but trifling.

The log-dam may be straight or curved in plan according to circumstances. If much water flows in the stream while the dam is being built, the foundation courses of logs will have to be sunk by loading them with stone. An opening will also have to be left in the dam to pass the stream during the construction. It must finally be closed by building the dam at this place as rapidly and strongly as possible.

In the case of a narrow stream (about 40 to 60 feet wide) a strong dam can be built of logs by adopting the pointed plan. The butts of the logs are placed against the banks and the points are notched where they cross each other. There are only two logs in each course—one from each bank. The logs must be fastened together with treenails or drift-bolts. The dam is like a roof placed on end. Its strength depends evidently upon an unyielding bearing or skew-back being provided for the butt ends of the logs. If the banks of the stream be rocky, a good bearing is obtained by trimming the rock to the required surface. When the banks consist of gravel or earth, timber-cribs filled with stone may be placed in the



banks to form the skew-backs for the logs. In the latter case the logs forming the dam should extend into the crib, being notched and spiked to its timbers. Water-tightness is obtained by filling in a slope of gravel on the up-stream side of the dam. An apron of logs placed closely together, having their top and bottom sides squared, should be constructed on the down-stream side.

Dams 10 to 15 feet in height have been built according to the simple plan just described, and have stood successfully for many years.

**Crib-dams.**—A more economical plan of using logs to form a dam than the plan shown in Fig. 69 consists in building cribs with the logs and filling the spaces between them—ordinarily 6 by 6 feet to 10 by 10 feet—with stone or gravel. Fig. 70 shows a crib-

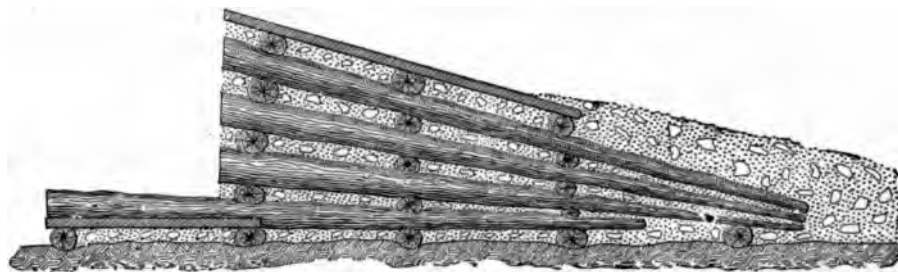


FIG. 70.

dam which has a triangular profile like the log-dam. The foundation course is formed of large logs, placed at right angles to the stream, and carried into the bank on both sides. These logs, which are generally placed 6 to 8 feet apart, are laid in trenches excavated to such a depth that the tops of the logs project just above the river-bed. If the width of the stream be considerable, two or more logs spliced together will be required for each of these trenches. The second course of logs is laid at right angles to the foundation course. The apron is formed between the two foundation-logs which are furthest downstream by placing planks between the logs of the second course. These planks should project under the third course of logs, with which the dam proper begins. Each course of logs is placed at right angles to the one below it. The logs are not notched where they cross each other, but simply flattened so as to form good bearings. They are spiked together by iron drift-bolts (usually  $\frac{3}{4}$  by  $\frac{3}{4}$  in.) at each intersection of logs. Wooden tree-nails of hard wood may be used instead of the spikes. The top cross-logs should be securely fastened by iron bolts passing through two or three logs beneath. In building cribs the timbers should be so placed that the pockets of the crib will have vertical sides. Formerly the timbers were often staggered so as not to be directly over those below, but nothing is gained by adopting this plan.

In the dam shown in Fig. 28 the triangular section is obtained by making the logs across the river smaller at the up-stream than at the down-stream side of the crib. The down-stream face of the dam is made almost vertical. A course of planks (about 4 inches thick and 12 feet long) securely spiked to the logs is placed on the up-stream side of the crest of the dam. This course is continued up-stream by a slope of gravel or earth.

Crib-dams can be used in almost any kind of river bottom. If placed on rock the bottom logs should be fastened to the foundation by iron bolts. For this purpose holes are drilled in the rock. The lower end of each iron anchor-bolt is split from 5 to 6 inches.

By placing a wedge in the split end of the bolt and driving the latter down into the drill-hole, the bottom of the bolt is expanded and anchors the log firmly to the rock.

Unless the dam is to have but little height, it will be found most convenient to form it of square cribs, placing a low crib in front of the main dam to form the apron, and a slope of gravel and earth on the up-stream side. This plan is the method usually adopted. Descriptions of some dams of this kind which have been constructed and which have stood successfully for many years are given on pages 145 to 147.

**Pile-dams.**—If the river bottom is soft, but does not contain quicksand, a substantial dam can be built by driving one to three rows of piles across the river, the piles in each row being driven as closely together as possible. Logs and brushwood are placed horizontally between or against the piles, according to circumstances. In Fig. 71 two rows of

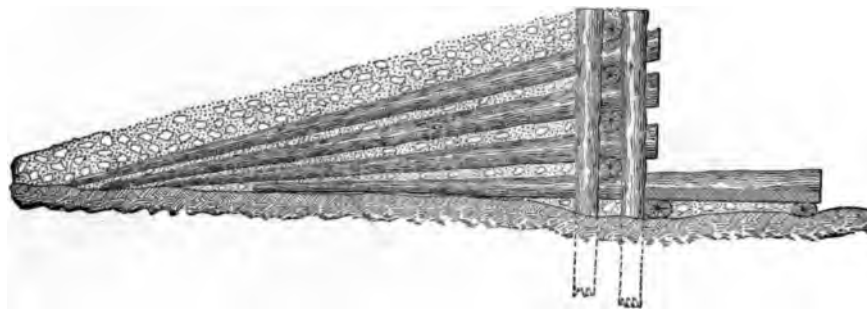


FIG. 71.

piles are shown, the horizontal logs and brush being placed between them. An apron is placed in front of the dam, and long piles are laid about 10 feet apart, as ties from the piling into the earth filling.

**Plank-dams.**—A strong dam can be formed by laying planks so as to form a vertical arch, convex up-stream. Planks 10 to 12 inches wide and 2 to 2½ inches thick may be used for this purpose. They should not be more than 12 feet long, so as to form short chords of the arch. If the dam be founded on hard rock no apron is required. A level bed must be prepared for the first course. Concrete or rubble masonry may be used to level the irregularities of the rock. At both ends of the dam skew-backs must be cut for the arch to bear against.

Having laid the first three or four courses of planks, they should be anchored to the rock by iron split bolts in the manner described on page 140. The heads of the bolts must be countersunk in the top plank. The other courses of planks are merely spiked or fastened by treenails to those beneath them. The joints between the planks should be cut on radial lines and closely fitted. With this dam, too, it is advisable to place a slope of earth and gravel on its up-stream side.

If a dam is to be built of planks on a soft or sandy river-bed an apron must be provided. A foundation is prepared for the dam by laying long, square timbers about 10 by 12 inches in section, or logs squared roughly to this size, either closely together or 2 or 3 feet apart according to the softness of the bottom and the height of the dam. The down-stream part of these timbers forms the apron, if they are placed closely together. If they be two or three feet apart planks are spiked to them to form the apron. Instead of building a single arch of planks, as described above, a double arch may be built as shown in Fig. 30, the space between the arches being filled

with earth, gravel, and stone. Such a dam would of course be stronger than the single-arch dam described above.

As the dam shown in Fig. 72 is supposed to be built in soft ground, strong abutments must be constructed to resist the thrust of the arches. Cribs made of planks

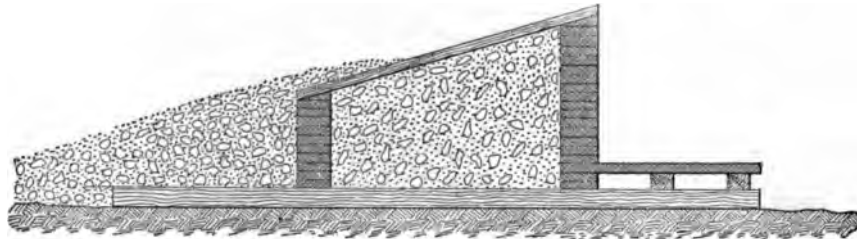


FIG. 72.

and filled with stone will answer for this purpose. Where the arches abut against the cribs the alternate courses of planks in the arches should be extended into the plank-cribs in order to tie the work well together.

A third plan of building a dam of planks is shown in Fig. 31. In this case the planks form a series of steps on either face, except at the lower part of the up-stream face, where they are laid as a vertical wall. Each course is securely tied by laying planks about 8 to 10 feet apart, at right angles across the dam, as shown in Fig. 73. The

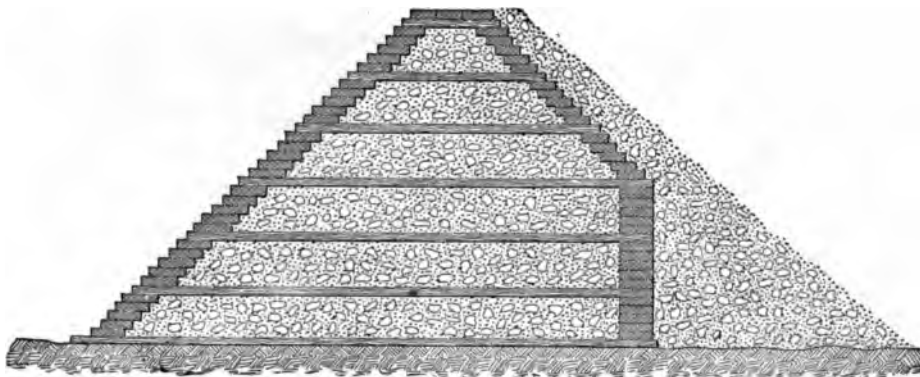


FIG. 73.

space between the planks is packed with earth and gravel and a slope of earth is placed on the up-stream side.

The planks used should be 10 to 12 inches wide and 2 to 3 inches thick. They may be spiked together, but it is preferable to fasten them together by wooden pins. These pins are usually made square to avoid splitting the planks in driving the pins. For soft-wood planks pins  $\frac{3}{4}$  by  $\frac{3}{4}$  inch are driven into round holes  $\frac{3}{4}$  inch in diameter. If the wood be hard the holes must be made somewhat larger.

The planks on the down-stream side should be of oak. On the up-stream side planks of sycamore, elm, etc., may be used below the water, but above it the planks should be of oak.

If a dam of the kind just described is to be placed on a soft bottom, a foundation of logs or square timber must first be laid, as already explained.

**Framed Timber Dams** are made in various ways, according to circumstances. On a rock bottom a dam of moderate height can be built like a tight board fence. For a dam 6 feet high, posts 16 inches square are placed about 12 feet from centre to centre, the foot of each post being put in a hole about two feet deep excavated in the rock. Each post is supported on the down-stream side by an inclined brace 12 inches square. One end of the brace is let about a foot into the rock and bears against a piece of 2-inch planking. The other end bears against a shoulder cut in the post. A thin key serves to wedge the brace and post firmly together.

Three horizontal timbers, about 6 by 10 inches, are placed in notches cut in the posts, on their up-stream side. One of these timbers is securely spiked at the bottom, one at the middle, and the other at the top of the post. Vertical pieces of 2-inch plank are nailed to the horizontal timbers. If well-seasoned plank be used, they should be spaced a trifle apart, as they will swell when they become wet. If the planks are green they will shrink when wet, leaving thus cracks between them. The difficulty of the swelling or shrinking of the planking may be overcome by placing alternately well-seasoned and green planks.

The top of each post should be levelled in the down-stream direction, to let water run freely off the post. The holes in which the posts are set should be cut in a dovetailed fashion, the dovetail being on the up-stream side. The end of each post is cut to fit the dovetail, a shoulder 2 inches deep being made on that side. The hole cut in the rock must be larger, of course, than the foot of the post. In order to secure the post firmly in the hole, a long, wide key, about  $2\frac{1}{2}$  inches thick, is placed on its lower side. It is important that this key should be well-fitted to the hole and that it be placed on the lower side of the post so that the pressure against the dam forces the key and post together. If the dovetail of the hole and the key are placed on the up-stream side of the post, the water-pressure will tend to force them apart.

To insure water-tightness and to prevent shocks from floating bodies it is advisable (but not absolutely necessary) to place a slope of earth and gravel against the up-stream side of the timber-dam. No apron is provided in this case, as the dam is supposed to be erected on a bed of hard rock. Should the rock be soft it must be protected by an apron.

Fig. 74 shows a simple kind of hollow frame dam. It can be used for any kind of a foundation, and requires much less timber than a dam made of logs. In Fig. 74

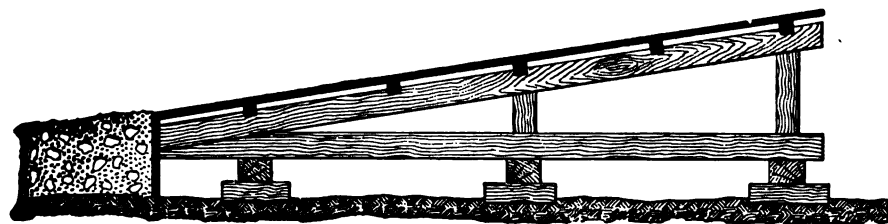


FIG. 74.

the dam is supposed to be built on a rock foundation. Short sills  $10'' \times 10'' \times 4'$  are securely bedded parallel with the current and 8 feet apart, centre to centre, in both

directions. On these bed-blocks the cross-sills of 12 by 12 inch timber are laid. Where joints occur on these sills 2-foot splices should be made, a block of wood being put under each joint. The cross-sills should be anchored to the rock by split-bolts  $1\frac{1}{2}$  to 1 $\frac{3}{4}$  inches in diameter, which should pass through the cross-sills, bed-block, and about 3 $\frac{1}{2}$  feet into the rock. For the down-stream sill bolts should be placed 8 feet apart, but for the up-stream sill a bolt should be put in every 4 feet, a block being put under the cross-sill at every point where an anchor-bolt is placed.

The cross-sills support the bents, framed of 10"  $\times$  10" timber, which are placed 8 feet apart. Cross-ties of 4"  $\times$  7" timber are fastened about 4 feet apart to the caps of the bents. The dam is completed by spiking 1 $\frac{1}{2}$  to 2 inch planks to the cross-ties. It is not advisable to use planks of much more thickness, as they are more apt to rot on account of the wood being wet on one side and dry on the other. The remarks made on page 286 about the spacing of the planks apply, of course, also to this case.

Fig. 75 shows another manner of framing the bents of a timber-dam. When it is necessary to break the force of the water the down-stream face of the dam can be

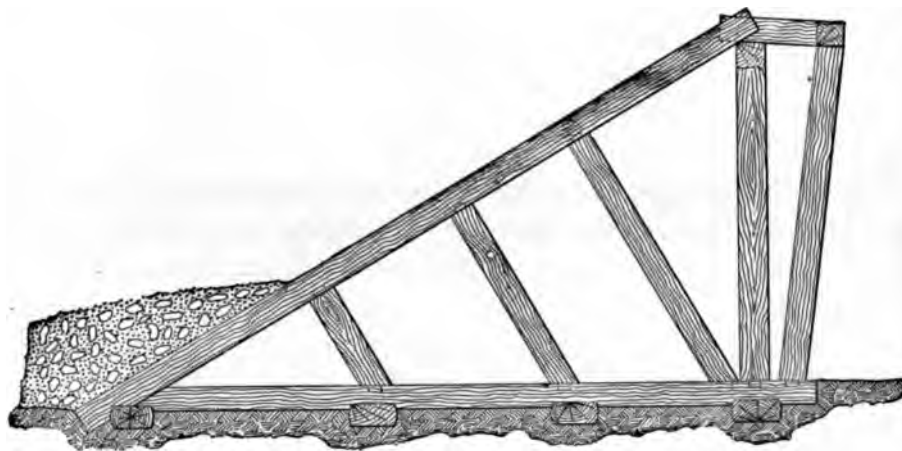


FIG. 75.

formed of a series of steps or an incline, as explained on page 280. A dam built at New Hartford, Conn., is a very good example of the latter style of construction. We shall describe it somewhat in detail to illustrate fully the construction of timber-dams.

**The Dam at New Hartford, Conn.**, was built in 1847 across the Farmington River for the Greenwoods Company. At the place where the dam was constructed the river bottom consists of cobble-stones, gravel, and quicksand. The banks are composed of gravel and sand.

The dam has a length of 232 feet on its crest. It was originally built 21 feet high, according to the trapezoidal profile shown in Fig. 67, the width at the bottom being 68 feet. Both faces of the dam make an angle of 27° with a horizontal plane. The timbers of which the dam is built are 9 to 12 inches thick. The courses of timbers were laid alternately crosswise and lengthwise of the stream, the first course being laid across the stream. The timbers parallel with the current are 6 feet apart, those at right angles to the stream are 2 to 3 feet apart. Where the timbers cross each other they were fastened

with  $\frac{1}{2}$ -inch round spikes, 20 inches long. Both faces of the dam were originally covered with 3-inch oak and chestnut planks, placed close together and fastened with 7-inch cut spikes. All the spaces between the timbers were filled with stone. The crest of the dam was formed by a strong cap-log.

The apron extends 14 feet in front of the dam. It consists of timbers 12 inches thick placed close together. The mudsill supporting the down-stream end of the apron timbers is supported by piles driven about 15 feet into the river bottom. The apron was well tied to the dam by using, every 6 feet, long timbers extending 25 to 30 feet into the dam. The other apron timbers run only 2 or 3 feet into the dam. Sheet piles were driven at the up-stream toe of the dam. A slope of gravel, reaching within 4 or 5 feet of the cap-log was filled in on the up-stream face. Substantial masonry abutments were built on pile foundations on both sides of the dam.

During freshets 6 feet of water frequently passes over this dam and as much as 10 feet has been recorded. As the apron of the dam did not extend far enough, the water washed out a considerable quantity of gravel in front of it, and the proprietors were obliged to build cribs of logs, filled with large stones weighing 2 or 3 tons, to protect the dam against being undermined. These cribs were chained to the piles supporting the apron.

After the dam had been standing about twenty years the upper 10 feet had to be renewed, as the timbers had become rotten. This was supposed to have been caused by the hot vapor forming in summer inside of the dam, which faces south. The planking was therefore removed from the down-stream slope of the dam to allow the vapor to escape.

**Dams across the Schuylkill River.\***—On Plate XCVI. we show sections of a number of timber-dams which have been constructed across the Schuylkill River, to obtain slack-water navigation. No. 1 was built in 1819 at Plymouth. It was constructed without a coffer-dam on a bed of rock. The bottom timbers (12 × 16 inches) were placed 8 feet apart, parallel with the stream and secured to the rock bottom by two-inch oak treenails. The other courses of timbers were laid alternately crosswise and lengthwise of the stream, the timbers being securely fastened together with treenails, no iron bolts being used in the dam. The up-stream face of the dam was covered with timbers 10 inches thick placed close together. Until this sheathing was laid the water could pass freely between the timbers, as no stone filling was placed in the dam. The covering was done from both ends until only 60 feet of the dam was left uncovered for the water to pass through. The remaining sheathing was carefully cut and fitted and placed quickly in the dam by a large force of men before the river could rise so as to interfere with the work. A slope of clay and stone was placed against the up-stream face.

This dam stood for thirty-nine years, withstanding successfully floods that rose to a height of 11 feet above its crest. Although it was built upon a tolerably firm micaceous rock in nearly vertical strata, covered ordinarily by about 2 feet of water, the rock in front of the dam was worn out in thirty-nine years to an average depth of 3 feet (nearly an inch per year).† The depth of the water on the crest was usually 6 to 18 inches deep. The structure was replaced in 1858 by the dam shown in sketch No. 3.

\* The facts stated about these dams and Plate XCVI. are taken from a paper on "Dam Building in Navigable and other Streams," by Edwin F. Smith, published in the Proceedings of the Engineers' Club of Philadelphia, for August, 1888.

† The Civil Engineers' Pocket Book, by John C. Trautwine, page 382.

The dam shown in sketch No. 2 was built in 1836. It was filled with stone and protected against leakage by sheet-piling. The framing in this dam was rather expensive, as the timbers had to be accurately fitted and joined. In 1846 the dam was raised for an enlarged navigation. It is still in an excellent state of preservation and has required but little repairs.

Sketches 3, 4, 5, and 6 show dams of more recent construction. They illustrate the type of dam now adopted for the Schuylkill Navigation. One of their characteristic features is that the up-stream face is made vertical or almost so. Experience has shown this type of dam to be cheaper, heavier, and stronger than the earlier kinds of dam built across the Schuylkill. It was urged against this type that the wide crest or comb would be damaged by debris or ice in floods, but long experience has proved that dams built according to this style are injured less than those having narrow crests.

Sketch No. 5 shows the Felix Dam which was built in 1855, 6 miles above Reading, Pa. It is 19 feet high and 27 feet wide at the base. It is similar in construction to No. 4. Although it has been subjected to heavy ice-floods, it is still in a remarkably good state of preservation.

Sketch No. 6 shows the Kernsville Dam, which was built on a gravel bottom in a gap of the Blue Mountains. It required a heavy apron to protect it from being undermined. In this case the apron was formed by extending the foundation-cribs of the main dam. This is not generally considered to be good practice on account of the injurious effect that may be produced on the main dam by the concussion of the overflowing water. In this particular case no harmful effect was apprehended, as the fall of the water was insignificant.

The Columbia Dam (Sketch No. 7) was built in 1875 across the Susquehanna River at Columbia, Pennsylvania. It is 6,847 feet long. Its average height is only  $7\frac{1}{2}$  feet above low water. The base was made 30 feet wide to give the dam sufficient weight and strength to resist the violent floods to which it is exposed. The crest of the dam is 16 feet wide and level. The up-stream slope is vertical; the down-stream slope has a fall of 21 inches in  $13\frac{1}{2}$  feet. The principal longitudinal timbers at the crest are of 12 by 13 inch white oak, in lengths of 40 to 50 feet. A covering of 5-inch white oak plank is placed over the crest and down-stream slope, and securely fastened with  $\frac{3}{4}$ -inch bolts  $12\frac{1}{2}$  inches long. The planks in the down-stream slope are placed  $\frac{1}{2}$  inch apart, to permit the water to keep the timbers wet.

On the up-stream face sheet-piling of 4-inch white pine planks, carefully jointed, was driven to the rock. This face of the dam is protected by plates of  $\frac{7}{8}$ -inch iron, reaching well over the crest timbers and down upon the sheeting.

The structure described replaced an older dam built with a narrow crest and a long down-stream slope, as it was supposed that the ice would pass freely over it. Experience proved this not to be the case. The Susquehanna River is noted for its great ice-freshets. In 1857, 4219 lineal feet of the dam was destroyed by ice; in 1865, 2500 feet; in 1873, 946 feet; and in 1875, 1085 feet. In the last mentioned year 2649 additional feet of the dam was damaged by the carrying away of the down-stream slope. On account of these experiences the dam built in 1875 (Sketch No. 7) was made with a wide crest like those adopted on the Schuylkill, and the results have proved to be very satisfactory.

...

This dam has withstood some of the severest ice-floods ever known on the Susquehanna. In thirteen years the level crest suffered very little, but the 5-inch oak planking on the down-stream slope, while almost uninjured at its junction with the crest, was worn down to 1 or 2 inches thickness at the point of the overfall, leaving the iron bolts by which it was fastened projecting 3 to 4 inches and bent over down-stream. If the dam had to be rebuilt, the down-stream slope would probably be abandoned, a level deck being adopted for the whole width of the dam.

In building dams in rivers subject to destructive ice-floods, a timber dam should be made as heavy as possible. This object will be best accomplished for low dams by adopting a square cross-section and placing a slope of stone and gravel to help the ice over the dam. The upper part of this slope should be protected by a paving of stone. It is not advisable to use much timber in such a dam, as it reduces the weight of the structure. In the winter of 1887-88 two short sections of the Columbia Dam, 50 to 60 feet in length, raised 12 to 18 inches. This was ascribed to the preponderance of white-pine timber used in the dam at these points. When these sections raised the dam was submerged in 10 feet of backwater caused by an ice-pack some miles below.

**The Holyoke Dam\*** (Plate CXVII.) was built in 1849 across the Connecticut River by the Hadley Falls Company (now the Holyoke Water-Power Co.). Before this structure was begun a temporary dam was built a little further up-stream to serve as a protection during the construction of the permanent dam and to furnish water-power in the meantime. The temporary dam was built somewhat like the permanent dam, constructed subsequently, but was given less strength. The gates of the temporary dam were closed on November 16, 1848. When the water reached within 2 or 3 feet of the top, the whole dam, except 75 feet on one end and 150 feet on the other, was rolled over and floated down-stream on the crest of a wave about 8 feet high. The loss to the company on account of this failure is stated to have been \$40,000 to \$50,000.

The permanent dam shown in Fig. 1, Plate CXVII., was begun the following year and finished in the summer. This dam is still standing, but will soon be replaced by a masonry dam below it. It is 1017 feet long and has a maximum height of about 30 feet. The down-stream face of the dam was originally made vertical, but in 1870 a sloping apron was built in front of the dam, as shown in Plate CXVII.

The dam was founded on a ledge of red slate and sandstone, which dips down-stream about 30° from a horizontal plane. The whole dam was built of heavy timbers, nothing less than 12 by 12 inches being used. The bottom timbers (15 by 15 inches in section) were placed parallel with the current and were bolted to the bed-rock with iron bolts 1½ inches in diameter, about 3000 of these bolts being used in the dam. The bottom timbers and those directly over them were placed 6 feet apart and divided the dam into 170 sections. The up-stream slope, which makes an angle of 20° 45' with a horizontal plane, was covered with three courses of 6-inch timber. This planking was strongly fastened together with spikes and treenails. The rolling top or combing was covered across the whole length of the dam with sheets of boiler-iron. Four million feet, board measure, of wood was placed in the dam.

As the dam was built up the pockets between the timbers were filled with stone to a

\* Paper by Clemens Herschel, Trans. Am. Soc. C. E., for 1886, and Engineering News of May 13, 1897.



height of 10 feet. Above this the dam was originally left hollow. The foot of the dam was protected by concrete. A bank of gravel was filled in against the up-stream face of the dam, beginning 70 feet above the dam and covering over 30 feet of the slope. Strong abutments of masonry were built on both sides of the timber dam. The total cost of the dam amounted to \$150,000.

During the construction of the dam the river-water was passed through 46 gates, each having an opening of 16 by 18 feet. These gates were closed for the first time on October 22, 1849, the water being thus forced to pass over the dam. The work stood this test very successfully. The leakage through the dam was very trifling, not more than was thought necessary to keep the timbers from decay.

In November, 1849, 6 feet of water passed over the top of the dam. It caused the windows in Springfield, 8 miles away, to rattle, as no provision had been made to allow the air to pass freely from abutment to abutment under the sheet of water. In April, 1862, 12½ feet of water passed over the dam, which is the maximum height the water has reached.

The water, ice, logs, etc., passing over it rapidly wore away the rock in front of it. By 1868 the ledge had been eroded to a depth of 20 to 25 feet, and the dam had become undermined in some places. Besides the wearing out of the rock, the front timbers had become injured by logs and ice which, after passing over the dam, were forced against the front face by the eddies caused by the falling water. In some cases logs having become wedged among the front timbers and being struck by the falling water forced the timbers apart, acting like large levers. In order to protect the dam against such injuries and to reduce the fall of the water, a large inclined apron of cribwork was built in front of the dam during the years 1868, 1869, and 1870 (Plate CXVII.). This crib, which exceeds the original dam in volume, was built of round logs laid so as to form pockets 6 by 6 feet, which were filled with stone to the top before the covering, consisting of 6-inch planks of hard wood, was put on. The cost of the apron is given variously as \$263,000 to \$350,000—about double the cost of the original dam.

The construction of the apron merely transferred the erosive action of the water further down-stream. The slope of the apron being nearly parallel with the dip of the rock, the circumstances for washing out the ledge were very favorable. By 1886 the rock in front of the apron had been eroded in places to a depth of 20 to 25 feet.

While the apron was being constructed a considerable amount of stone was also filled into the old dam. This work was done carelessly, stones weighing 4 to 5 tons and even whole scow-loads of stone being occasionally dropped on the up-stream slope of the dam. The leakage through the dam, which in after years entailed much expense, was probably partly due to the injuries thus sustained.

From 1849 to 1879 only trifling repairs were required on the dam with the exception of the construction of the apron. In the latter year a break occurred in the plank covering of the up-stream slope. Many similar breaks taking place in the next few years, the whole up-stream slope was replanked in 1885. At the same time sheet-piling was driven longitudinally through the dam, about three bents back from the face, and gravel dumped and puddled on both sides of the sheet-piling. The cause of the breaks was the rotting of the planking (which, as already stated, had been injured by stones being

dropped on it) and also of some of the timbers. For a full account of how the dam was repaired we must refer the reader to Mr. Clemens Herschel's Paper (Trans. Am. Soc. C. E., for 1886).

As the repairs appeared to have no permanent effect in stopping the leakage, it was finally decided to build a masonry dam 112 feet at one end and 132 feet at the other downstream from the old timber structure. Surveys for the new dam were made in 1891. The construction was begun in 1895. It is expected that the dam will be completed during the season of 1899.

Figs. 2 and 3, Plate XCVII., show the profile adopted for the masonry dam. The upper part of the down-stream face is the parabola, which a sheet of water 4 feet in depth over the crest would describe in falling freely. The parabola continues to the point of reversing below which a cycloid (the curve of "quickest descent") is adopted for the face. At the extreme toe the face is turned somewhat upwards to break the force of the water and to prevent it from cutting the ledge beyond. The back slope forms a series of steps, 5 feet high, equivalent to a batter of 1 foot in 5 feet. The length of the rollway of the new dam will be 1020 feet. The plans for the masonry dam\* were prepared by Mr. E. S. Waters, Chief Engineer of the Holyoke Water Power Company.

In conclusion, it may be of interest to mention some of the lessons taught by the old timber dam and summarized by Mr. Herschel in his "Paper":

1st. A wooden dam should not be left hollow, as the foul air on the inside will eventually rot the timbers. A stone filling will not prevent this decay, but a tight filling of gravel will protect the timbers against rotting.

2d. A masonry shelf on a masonry abutment should not take the place of the last frame of a dam. The dam will probably settle, but the masonry will not, and thus a distortion will be produced in the framing of the dam.

3d. The down-stream face of the dam should never be vertical unless the height be very insignificant.

4th. An apron should be provided and given a proper form to prevent the water from washing out the river-bed in front of it.

A long, steep slope of timber on the up-stream side of a dam is very objectionable. Mr. Edward F. Smith has pointed out that if the plan of the original Holyoke Dam had been turned around so that the up-stream face would have been downstream, and if a broad comb 10 to 15 feet wide had been added at the up-stream (vertical) face of the dam, adding about 30 per cent to the mass of timber and stone, the cost of the expensive crib-apron would have been saved.†

A slope of gravel on the upstream side instead of the long timber one would have made the dam tighter and have avoided all the expensive repairs which became afterwards necessary.

The simple triangular profile shown in Fig. \_\_\_\_\_ is often adopted for low dams, but the experience with the Holyoke Dam proves clearly that such a profile should never be used for a high fall of water.

---

\* For a full account of the manner in which the masonry dam is being built, see *Engineering News* for May 13th, 1897.

† *Proceedings of Engineers' Club of Philadelphia*, for August, 1888.

The Canyon Ferry Dam was built in 1898 across the Missouri River near Helena, Montana, for the Helena Water and Electric Power Company. All the plans for the work were prepared by Mr. J. T. Fanning, the Consulting Engineer of the Company.

Fig. 76 shows a section of the dam which consists of timber cribs filled with stone. It is 485 feet long and 29 feet high. The timbers are fastened together with iron drift-bolts 20 to 30 inches long. The down-stream face of the dam formed originally three steps to break the force of the water and prevent it from scouring out the river-bed. The steps were covered with 20 inches of timber (two courses 10"×12" timbers laid on the 12-inch side). The risers were covered with two courses of 3-inch plank, lap-jointed. The back of the dam was covered in a similar manner with 2-inch plank. An earth slope, riprapped at the

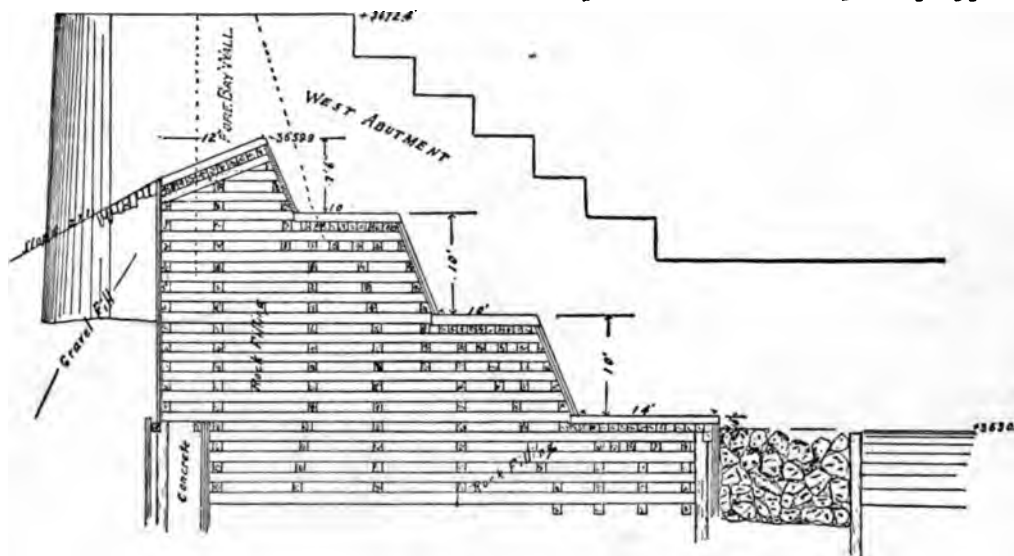


FIG. 76.—CANYON FERRY DAM.

top, was placed against the back of the dam, and below the dam large rocks were filled in to the surface of the river for a distance of 25 feet, being held in place by a row of round piles.

The timber-dam was founded on a bed of gravel and granite sand, which is almost impervious to water. Both above and below the crib-dam a row of triple-lap sheet-piling made of 3 by 12 inch plank, stiffly bolted together, was driven to a depth of about 12 feet below the river-bed.

Masonry abutments were built on both sides of the crib-dam to a height of  $12\frac{1}{2}$  feet above its crest. On the east bank an earth dam 285 feet long, having a masonry core-wall and slopes of 2 to 1 and  $1\frac{1}{2}$  to 1 respectively on the up-stream and down-stream sides,\* was built to the hillside, the top of the dam being at the level of the top of the abutments.

\* Soon after the dam had been completed, 5 feet of water passed over its crest. With this depth the sheet of water, after passing over the first step, cleared the other two and struck the apron and protection riprapp with such force as to cause scouring. As a result of the undermining, part of the dam, about 200 feet long, settled and moved out of line, the maximum settling being about a foot and the maximum movement down-stream being 5 to 6 feet.

The dam was repaired with new cribbing, heavily anchored and tied together. A timber apron, 49 feet long, was placed down-stream of the dam, and two slopes of timber were substituted for the three steps, the first slope being 39 feet long and the second having a length of 60 feet.

## CHAPTER V.

## STEEL DAMS.

**Steel Dam at Ash Fork, Arizona.\***—This dam is situated four miles east of Ash Fork, a station of the Santa Fé Pacific Railway (Atchison, Topeka and Santa Fé Railway system). It was constructed to form a reservoir for supplying water service for the railroad.

The reservoir stores 36,000,000 gallons. It is formed in a dry canyon, known as Johnson's Canyon, in which water flows only at two periods each year. Before the reservoir was constructed the water required for the service of the railroad, about 90,000 gallons per day, had to be brought in tank-cars from a distance of 27 to 45 miles.

The steel portion of the dam has a length of 184 feet, the total length on top of the dam, including masonry abutments, being about 300 feet. Its greatest height is 46 feet. The steel part of the dam consists of 24 triangular bents 12 to 42 feet high, which are placed 8 feet from centre to centre on concrete foundations. The bents form with the rock bottom of the canyon right-angled triangles having their inclined sides, which are on a slope of  $45^\circ$ , turned up stream. The structure is composed of alternate rigid and loose panels. The general arrangement of the panels and of the bents and details of one of the highest bents is given on Plate XCIX. Fig. 1 of Plate BB shows the construction of the dam. The up-stream inclined columns of the bents are formed of 20-inch I-beams, weighing 65 pounds per yard, which are reinforced on their under side with a plate one-half inch thick and 18 inches wide. Each vertical or inclined post is composed of 4 Z-bars and a web plate. Alternate panels of the structure have transverse diagonal bracing.

The crest or apron plates, which fit the braced panels between the bents, are riveted to a curved angle which is riveted to the upper end of the curved plate, while in the unbraced panels this angle merely bears on the apron plate. This arrangement makes provision for expansion and contraction.

The face of the dam is formed of steel plates,  $\frac{3}{8}$  inch thick and  $8' 10\frac{1}{2}''$  wide, which are riveted to the outer flanges of the inclined I-beams of the bents. The plates are generally 8 feet long and are curved to a radius of  $7\frac{1}{2}$  feet, so as to form a series of gullies down the face, leaving a flat part to be riveted to the I-beams.

The curved plates do not, however, extend into the concrete foundations. They are replaced in the bottom course by flat plates, the bottom curved plates being dished to a radius of  $3' 8\frac{1}{2}''$ , forming a segment of a sphere. The edges of all face plates and their splices are planed to a bevel edge for calking.

---

\* See *Engineering News*, May 12, 1898, and "Structural Steel Dams," by F. H. Bainbridge, in *Journal of Western Society of Engineers*, October 1905.

PLATE BB



ASH FORK STEEL DAM.



REDRIDGE STEEL DAM.



A masonry abutment, with its water face on a slope of  $45^\circ$  projecting 6 inches beyond the steel work into the reservoir, is built at each end of the steel dam. The steelwork is anchored into these abutments by two angle sheets. All the steelwork is painted with two coats of Detroit Sulphite Paint. The structure is covered on the down-stream side by corrugated iron plates to keep visitors away.

No special spillway is provided, as the dam is designed as an overflow weir. Its curved crest plates project on the down-stream side. The outlet is a 6-inch pipe bedded in concrete in a trench excavated in rock, under the dam, the pipe terminating in a drain within the reservoir. From the down-stream side of this pipe a 4-inch pipe extends to Ash Fork.

When the reservoir was filled the steel part was found to be perfectly water-tight, but leakage occurred where the steel plates joined the concrete at the sides and bottom of the dam. In 1900 the concrete was covered with asphalt, and the whole structure is now reported to be water-tight.

The dam was designed by Mr. F. H. Bainbridge in collaboration with Mr. James Dun, Chief Engineer, and Mr. A. F. Robinson, Bridge Engineer of the Santa Fé system of railroads.

**The Redridge Dam, Michigan,\*** was constructed in 1901 to form a reservoir for supplying water to the stamp-mills of the Atlantic Mining Company and of the Baltic Mining Company. In this case the concrete base was made sufficiently strong to resist overturning and sliding instead of depending on anchorage to the bed-rock, as in the Ash Fork dam.

The steel portion of the dam has a length on the crest of 464 feet and a maximum height including the concrete base of about 74 feet above the rock foundation. The steel bents are placed 8 feet apart. Figs. 1 and 2, Plate C, show respectively the lowest and the highest bent in the dam. Fig. 2 of Plate BB gives a view of the dam during erection.

The face members of the bents consist of 15-inch I-beams for the low bents and 24-inch I-beams for the high bents. The face plates are of  $\frac{3}{8}$ -inch steel plate 16 feet long curved concave to the water to a radius of  $7' 5\frac{1}{8}"$ .

These plates have on each side a flat strip  $5\frac{1}{8}$  inches wide, which is riveted to the flange of the I-beam. A course of flat plates is placed below the lowest course of curved plates, the open space left between the plates being closed by an inclined diaphragm. The vertical joints are double-riveted, the face plates lapping each other on the I-beam. The rivets are  $\frac{3}{4}$  inch in diameter with  $2\frac{1}{2}$ -inch pitch. The ironwork is continued with  $\frac{1}{8}$ -inch plates down the vertical face of the concrete base.

The face plates were given a coat of Edward Smith & Company's durable metal coating both before and after the erection. The rest of the structure was painted with graphite paint.

A special waste-weir is provided for this dam.

The work was designed by J. F. Jackson, M. Am. Soc. C. E., Engineer of the Wisconsin Bridge & Iron Company. F. Foster Crowell, Mem. Am. Soc. C. E., acted as Consulting Engineer.

---

\* See *Engineering News*, August 15, 1901, and "Structural Steel Dams," by F. H. Bainbridge, in *Journal of Western Society of Engineers*, February 1903.

The Hauser Lake Dam (Plate CC) was recently constructed for the Helena Power & Transmission Company across the Missouri River, about 15 miles from Helena, Montana. It is built of steel, in a similar manner to the two steel dams described above, but some improvements were made in the details. It is 630 feet long and has an average height of about 75 feet. The up-stream slope is  $1\frac{1}{2}$  horizontal to 1 vertical. The dam was founded partly on gravel and partly on solid rock. Friestedt steel sheet piling, 35 feet long, was driven at the up-stream toe of that part of the dam that was founded on gravel, and steel plates were connected to them.

The dam was designed by J. F. Jackson, M. Am. Soc. C. E., Engineer of the Wisconsin Bridge & Iron Company, who has furnished the author with the information given above. The dam has a factor of safety of 4 against overturning and of 2 against sliding. A waste-weir, 500 feet long, having its crest 12 feet below the top of the dam, was provided.\*

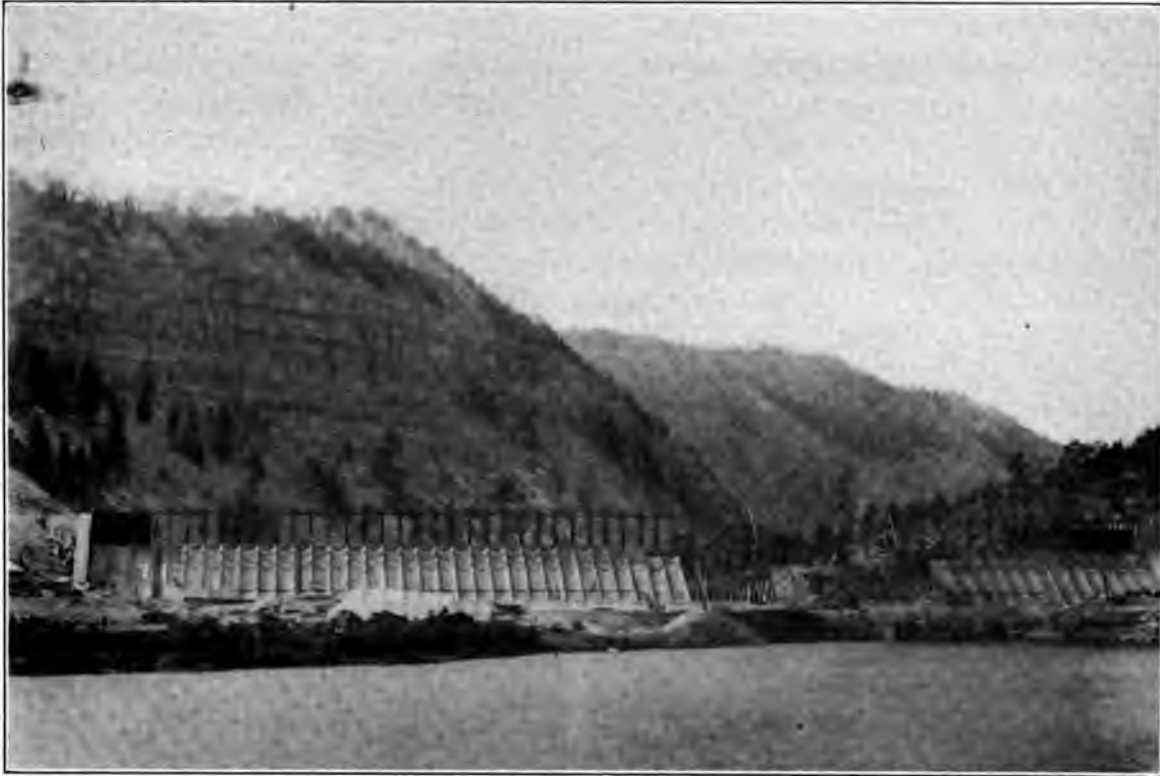
---

\* On April 14, 1908, the Hauser Lake Dam failed by being undermined by the river, at the east shore, where the steel sheet piling that had been driven in gravel joined the rock. All of the steel dam that was founded on rock, amounting to 320 feet in length, remained standing, but the central portion that was founded on gravel was washed away. Steps have been taken to rebuild the dam at once.

A full description of the Hauser Lake Dam was given in *Engineering News* of November 14, 1907, and an account of the break of the dam was published in *Engineering News* of April 30, 1908.



PLATE CC.



HAUSER LAKE DAM IN CONSTRUCTION.



HAUSER LAKE DAM IN CONSTRUCTION.



## PART III.

### MOVABLE DAMS.

---

#### CHAPTER I.

##### FRAME-DAMS.

**Canalization of Rivers.**—On many rivers navigation becomes impossible at shoals during periods of low water. In early times boats had to be kept at such places until rain-storms raised the river sufficiently to carry them over the shallow points. The first improvement attempted to remedy this trouble consisted in building dams (weirs) across the river where needed to increase the depth of water for "slack-water navigation." Each of these dams had usually one or more openings, which could be temporarily closed by "stanches" consisting of spars, planks or gates, bearing at the bottom against a sill and at the top against movable wooden beams. By removing these beams suddenly, and thus releasing the stanches, an artificial flood was produced which carried any boats that might be above the dam through the openings and over the shoals below. This process was called "flashing," or "flushing." It was in use on several rivers in France until the middle of this century and also in England on the Thames and Severn.\* Instead of vertical planks, etc., for stanches, horizontal beams (poutrelles), placed one on top of another, were sometimes used in France to close openings of 15 to 18 feet in a dam. By a suitable arrangement, these beams could be suddenly released for flashing.

In order to make it possible to take a boat up or down stream without removing the stanches, a lock was often built at these dams. By constructing at suitable points dams with locks or stanches, a river was practically converted into a canal,† with the difference, however, that it still remained subject to floods, for which provision had to be made.

**Needle-dams.**‡—About the end of the eighteenth century the French Government commenced to improve internal navigation by constructing substantial "navigable

---

\* Minutes of Proceedings Inst. C. E., Vol. IV., p. 111.

† The river Lot, in France, was the first river to be canalized in this manner. Dams were built across this river in the thirteenth century and locks were introduced in the fifteenth century.

‡ The authorities on movable dams, which the writer has consulted, are given on page 411. For the historical notes on works of this character in France, he is indebted to Lagrené's "Cours de Navigation Intérieure" and to memoirs on Movable Dams that have appeared since 1830 in the "Annales des Ponts et Chaussées."

passes," 26 feet wide, in some of the dams built across rivers, especially on the Yonne, a branch of the Seine. These passes were built with side-walls and aprons of masonry. They were closed by small wooden spars called needles, which bore on the bottom against a masonry sill and at the top against wooden beams, pivoted on iron pins placed in the side-walls. Later on, the width of the passes on the river Yonne was increased to 40 feet, a cable which could be slacked or stretched as required being substituted for the pivoted beams. As a pass only 40 feet wide was found to involve considerable inconvenience and danger to navigation, M. Poirée, who had charge of the improvements on the river Yonne, increased the width of the pass at Basseville, which was constructed in 1834, to 72 feet. For such a width a cable could no longer be used for supporting the upper ends of the needles. M. Poirée substituted for the cable a series of short iron bars, which were fastened to the top of iron frames (trestle-bents), placed at short intervals across the pass, from one side-wall to the other. In the Basseville dam these frames were originally two metres (6.56 feet) apart, but this distance was afterwards reduced to one-half. In needle-dams erected subsequently the distance between the frames varies from 3 to 4 feet.

One of the chief features of M. Poirée's invention was the manner in which he removed the frames when the pass was to be opened. This was accomplished by removing the needles by hand, unhooking the bars connecting the frames, and turning the latter down on journals placed in their lower bases until they rested in a recess in the masonry apron, presenting thus no obstacle above the sill of the floor. It was objected at first that the frames would be silted up while lying thus on the apron, and that it would be very troublesome to raise them again, but experience on the Yonne and similar rivers has proved that no difficulty has been experienced in this respect, as the bents are only turned down during periods of high water, when but little silt is deposited.

In Fig. 77\* we show one of the earlier Poirée dams. The frames are made of bar iron about  $1\frac{1}{2}$  inches thick. Each frame has a trapezoidal form, the top and bottom pieces being horizontal, the up-stream post vertical and the down-stream post slightly inclined. A diagonal brace serves to stiffen the frame. The ends of the lower base form journals which fit into cast-iron boxes fixed in the floor. The frames are 6.23 feet high, 2.56 feet wide on top, and 4.92 feet wide at the base. They are placed a metre (3.28 feet) apart, and weigh each 242 pounds. Wooden planks placed on top of the frames form a bridge which enables the dam-tender to replace or remove the needles, etc. Two men are able to raise or lower a frame by means of iron chains joining their tops.

When erected the frames are fastened together on top by connecting bars, both on the up-stream and down-stream sides. The up-stream bars are made stronger than those on the down-stream side, as they have to support the upper ends of the needles. The bars are made in various ways. In the dam shown in Fig. 77 the bars are pivoted at one end and provided at the other with a hook which can be attached to a pin on the cap of the adjoining trestle. In some of the earlier dams

---

\* Figs. 77, 83, and 105 are taken from the "Paper by B. F. Thomas on Movable Dams," Trans. Amer. Soc. C. E. for 1898.

the connecting bars had pinholes at both ends, and were placed over pins attached to the caps.

The construction of the first Poirée needle-dam was soon followed by others, the details being perfected and frames of greater height being used to secure a greater depth

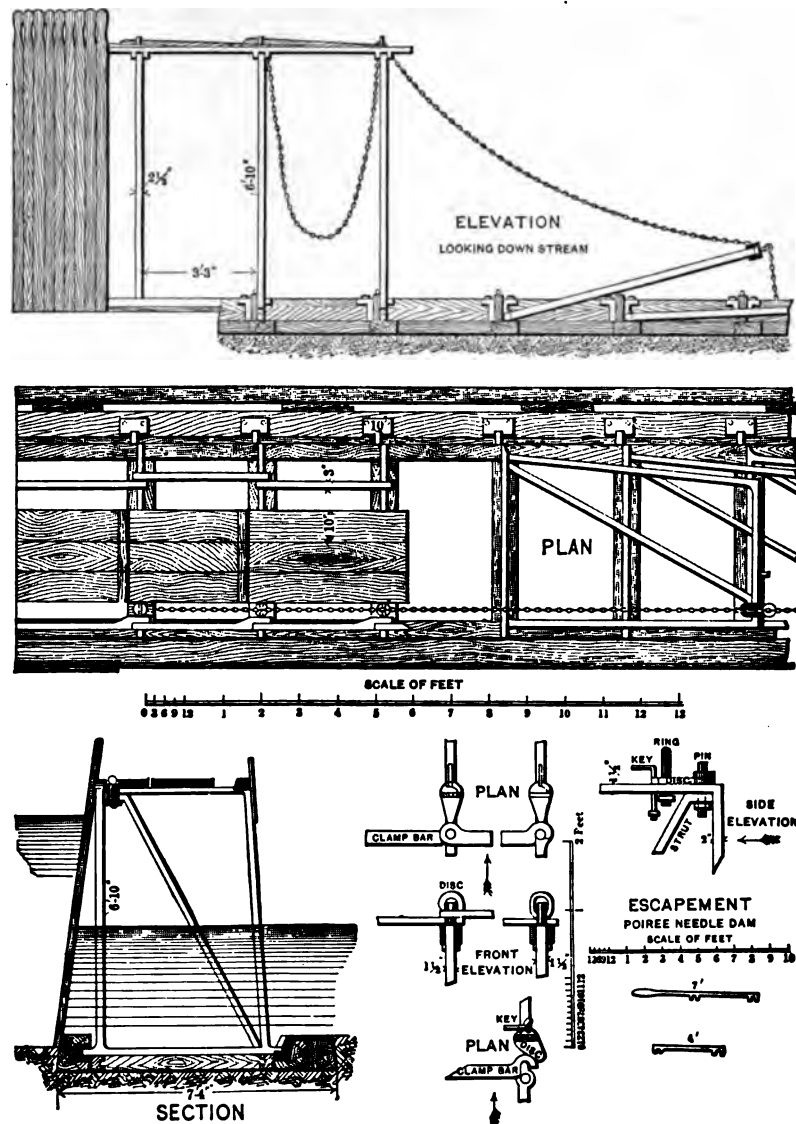


FIG. 77.—POIRÉE DAM.

of water for navigation. The second needle-dam was built at Decise, on the Loire, in 1836. A similar work, described below, was constructed in 1838 at Épineau, on the Yonne. In 1840-45 needle-dams were built to replace the fixed weirs on the Saône, which caused great damage during floods. Needle-dams have been erected on the following streams in France: The Seine, Marne, Oise, Cher, and Allier; and also on the Belgian Meuse and on the Main in Germany. A dam of this kind constructed in the United States is described on page 309.

The Needle-dam at Épineau, on the Yonne, built in 1838, is one of the earliest works of this kind. A description of the dam, written by M. Chanoine, the engineer

in charge of the construction, is given in the "Annales des Ponts et Chaussées" for 1839, First Series, p. 238. The dam had a length of 230 feet and a height of  $6\frac{1}{2}$  feet above the sill. The frames, which were placed a metre apart, were made of bar iron  $1\frac{1}{2}$  inches square. Each frame was 7 feet high, 4 feet 7 inches wide at the base and 4 feet 3 inches wide on top. The wooden needles were  $2\frac{1}{4}$  by  $1\frac{1}{2}$  inches in section and 8 feet long, each weighing about 13 pounds.

In several similar dams that were constructed subsequently on the Yonne, the frames were made 7 feet  $4\frac{1}{2}$  inches high and placed 3 feet 7 inches apart.

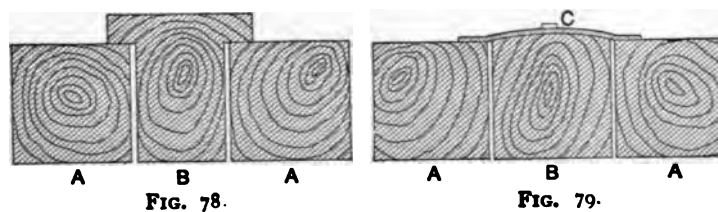
The Needles used in Europe have generally been made of red pine. In the first dams they were only about  $1\frac{1}{2}$  inches square and 8.2 feet high, each needle weighing, when wet, about  $4\frac{1}{2}$  pounds. As higher dams were constructed, heavier needles had to be used. The largest needles in France are  $4\frac{1}{2}$  inches square and 16 feet 5 inches long, each weighing about 100 pounds. A needle of this size and weight can still be placed by hand, but heavier needles have to be handled by machinery. Needles 8 inches square have been experimented with in France, but abandoned as too heavy. In an American dam (page 310) needles  $4\frac{1}{2}'' \times 12'' \times 14' 3''$ , weighing each 263 pounds when wet, have been used, but they are placed by means of machinery. The needles have a square or rectangular cross-section. For high pools the thickness of the needle is reduced according to the strain to which it is subjected, the width remaining, however, the same. Needles having a hexagonal or semi-hexagonal section have been experimented with but have not yet been introduced.

The top of the needle is formed into a handle. It is generally provided with an iron ring and sometimes with a hook serving to attach the needle to the supporting-bar. When the needles are to be released mechanically by turning the supporting-bar, those between two adjoining frames are usually fastened to the same rope, which passes through the iron rings or through eyes in the needles. This rope is attached to a hawser, one end of which is fastened on shore. By this arrangement the needle can easily be recovered.

As the height of Poirée dams became greater two difficulties were encountered:

- 1st. The needles were often broken in handling;
- 2d. The leakage between the needles increased considerably.

To avoid breakage heavier needles, proportioned according to the pressure they were to sustain, were introduced. In some dams a wooden bar has been placed on the up-stream side of the frames to relieve the needles of some of the pressure they have to bear. The bar is suspended by chains and bears against the needles at about



one-third the height of the part under pressure. Hollow needles have been proposed, as giving greater strength for the same weight than solid spars, and it has also been

suggested for high dams to use two sets of needles, one for the lower and one for the upper part of the dam.

The leakage can be diminished by placing straw, etc., in front of the dam. Alternate needles of a "T" form (Fig. 78), or with india-rubber facing ("C" in Fig. 79), have been proposed. None of these improvements suggested to avoid leakage and breakage have yet been practically introduced.

**Frames.**—In the first needle-dams the frames were only about 7 feet high. As such dams were built later on to retain greater depths of water, the height of the frames had to be increased. In the Martot Dam, on the Seine, the frames are 11 feet high. The frames of the dam at Louisa, Kentucky (page 309) are 15.17 feet high.

The simple construction of the early frames had to be modified as their height was increased. "T" or "U" iron, etc., were used in the frames as giving

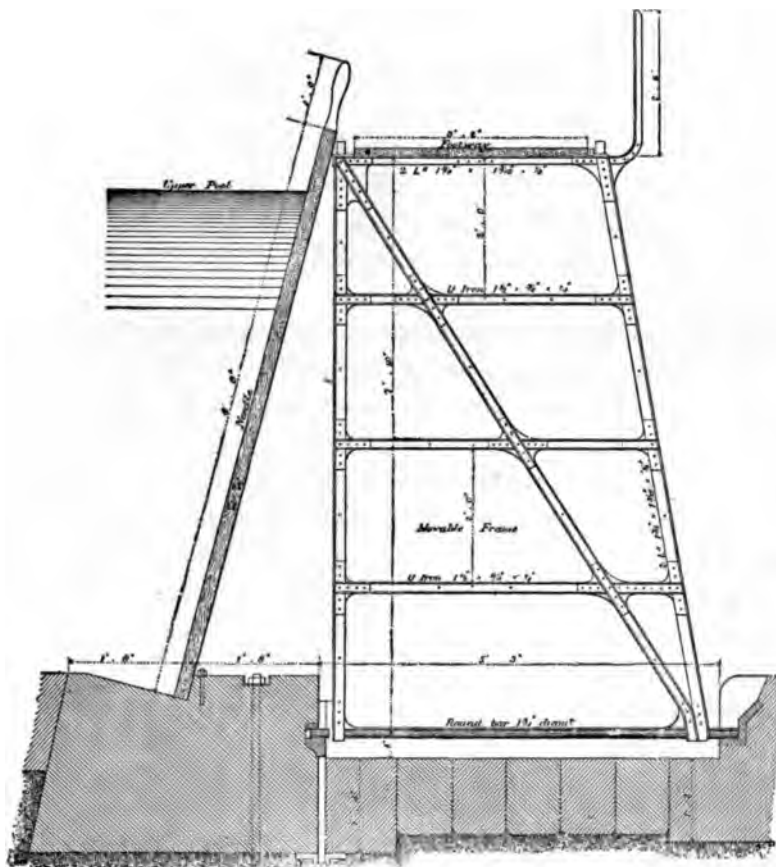


FIG. 80.—POIRÉE NEEDLE-DAM.

greater strength for the same weight than bar iron. More bracing was also required. Fig. 80\* shows a modern frame. In some dams the frames are surmounted by light framework in order to raise the foot-bridge so as to be above all danger of

\* Figs. 80 to 93, and 98 to 102, are taken from "Fixed and Movable Weirs," by I. F. Vernon-Harcourt, in Minutes of Proc. Inst. C. E. for 1880. Figs. 87 to 91 are taken from a paper on the River Seine by the same author, in Minutes of Proc. Inst. C. E. for 1886

submersion. Standards for a rope-railing were also attached to the frames on the down-stream side in order to reduce the danger to which the dam-tenders were exposed in handling the needles at night or in stormy weather.

The chains that were attached to the caps of the frames of the early dams have been omitted in some more modern constructions in France, as the frames can be readily raised by means of boat-hooks.

**Improvements** were soon introduced in the details of needle-dams. One of the most important was the substitution of an iron foot-bridge for the wooden planks (Fig. 81, page 308), an invention made by M. d'Haranguier de Quincerot. The iron bridge was arranged in such a manner as to fasten the frames together when up and to fall with them when lowered, partially covering them when down. The frames of the dams on the Cher are arranged in this manner.

Another improvement was the introduction of a releasing contrivance, which allowed the supporting-bar between any two adjoining frames to swing loose, setting thus the needles free, which were attached to a rope and could be easily recovered. This contrivance became more important as the height of the Poirée dams was increased. MM. Poirée and Chanoine invented such contrivances for dams in France whereby a length of dam of 130 feet could be opened in fifteen minutes, instead of requiring an hour by the primitive method of removing the needles by hand. A very simple release device, invented by M. Kummer and used in dams on the Belgian Meuse, is described on page 308.

In the early Poirée dams no special provision was made to carry off flood-waters except by the overflow formed by the fixed part of the dam. As the foot-bridge of the needle-dam had to be kept low (about 12 to 18 inches above the water), it was exposed to the risk of being submerged, which would make it impossible to lower the dam. To avoid this danger the upper part of the overflow-weir was made movable by placing on its crest some kind of shutter, such as the Chanoine wicket (described on page 327), which could be readily removed.

**Method of Working.**—Two attendants were able to perform by hand all the work of raising or lowering the first Poirée dams. Supposing the frames to be down, the attendants erected the dam in the following manner: They first raised the frame nearest the abutment (which was the last one to be lowered) by means of the chains fastened to it, or with boat-hooks, attaching it temporarily by a hook or clamp to a ring fixed in the abutment. The planks of the foot-bridge were next laid from the abutment to the erected frame, which was then firmly attached to the abutment by the up-stream and down-stream connecting-bars. The other frames were then raised and attached in succession in a similar manner. A handle with projections (Fig. 77) served to hold a frame temporarily in place until the planks were laid and the connecting-bars were attached.

In placing the needles every other one would first be put into position so as to dam the water gradually, the intermediate needles being finally placed. The needles, even including those weighing up to 100 pounds, were placed by hand in the dam by shoving them into the water so as to allow the current to bring their lower ends against the sill. In the large dams on the river Marne (France) each needle is pro-



vided with a handle and an iron hook. In placing a needle, which in these dams weighs about 103 pounds, it is held horizontally until the hook has been attached to the supporting-bar, and then the point of the needle is lowered into the current, which carries it against the sill. The distance from the hook to the point of the needle is made about half an inch longer than the distance from the supporting-bar to the sill. This causes the foot of the needle to scrape along the floor before striking the sill and thus avoids all shock. When lighter needles are used they may be pushed almost vertically into the water so as to bear against the sill.

The attendants soon acquire considerable skill in performing their work. They are nevertheless exposed occasionally to danger in lowering a dam at night and in stormy weather. The necessity of doing so was, however, later on almost eliminated by providing ample overflow-weirs having movable parts, which were more easily handled than needles, and by organizing a system of signals by telegraph, telephone, etc., along the river, giving ample notices of freshets likely to occur.

As the weight of the frames and needles increased, some power had to be supplied for handling them. This has usually been done by means of a windlass placed on a little truck moving over the trestles on rails. This truck serves also for transporting the needles. In some cases the dam-tenders have worked from a boat placed on the down-stream side of the dam, but experience proved that they were exposed to more danger, especially in lowering the dam, in a boat than when working from a bridge.

**Needle-dams in Belgium (Fig. 81).** In 1875-78 twenty-seven needle-dams were constructed on the Belgian Meuse. They contain all the improvements made up to that date. Each of these works consists of: A lock, having an available length of 328 feet and a clear width of 39.33 feet; a navigable pass 150 feet long, which can be closed by a needle-dam; and an overflow-weir 179 feet long, on top of which Chanoinie wickets (page 327) are placed. The sill of the weir is laid at low-water; the sill of the pass is placed 2 feet lower. When the dam is up the pool formed is 10.17 feet above the pass-sill.

The frames of the pass are placed 3.93 feet apart, centre to centre. They are 8.36 feet wide at the base, 4.76 feet wide on top, and 11.48 feet high from the floor to the under side of the collar of the bar supporting the needles.

The frame is made of wrought-iron bars. It is stiffened by a diagonal brace consisting of two pieces. A horizontal tie passes between the two bars of the brace, as shown in Fig. 81.

The top of the frame, when up, reaches the normal level of the water in the pool. The foot-bridge is kept about 18 inches above the water by placing on top of the frame two short iron posts, each 19.7 inches long, one at the up-stream and the other at the down-stream end of the cap. The former consists of a piece of tube and is part of the arrangement for releasing the needles, as explained hereafter. The latter is made of a solid piece of iron. The axle from which the iron floor is hung connects these short posts. The total weight of a frame, including the floor, escape-bars, etc., is 1108 pounds. The up-stream journal-box for the axle on which the frame turns is let into the sill and held by screws and bands. The down-stream journal-box is bolted to the stone. These boxes weigh respectively 70 and 200 pounds.

The frames are held rigidly together by a sheet-iron floor 3.64 feet wide. One end of each section of floor is permanently attached to a frame by the axle on which it revolves; the other end terminates in claws which grasp the cap of the next frame. The floor is connected at the abutment, pier, and lock-wall to iron bars like the caps of the frames, which are fastened to the masonry.

The needles are made of red Riga fir. They are 12.3 feet long and  $3\frac{7}{8}$  inches wide. At the point of maximum pressure and for 10 inches each way the needles are  $4\frac{1}{4}$  inches thick. They are  $3\frac{1}{8}$  inches thick at the bottom and  $3\frac{1}{2}$  inches at the top. Each needle is finished at the top so as to form a handle 9 inches long, ending in a

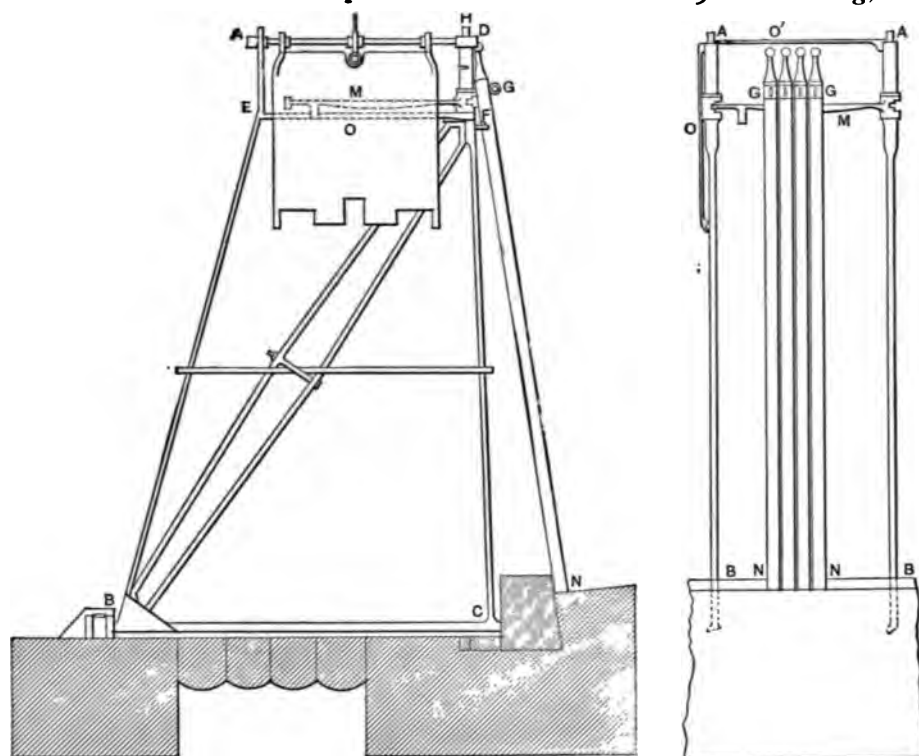


FIG. 81.—BELGIAN NEEDLE-DAM.

ball. It is provided with an iron ring, through which a rope passes that connects the eleven needles of each bar. One end of this rope is tied to the down-stream leg of the trestle, the other end is knotted.

The needles, which weigh 55 pounds apiece, are placed by hand by the dam-tender. When it is desired to release the eleven needles between any two frames, the rope connecting the needles is fastened to a hawser tied at one end to the pier or shore. The escapement is then turned and the needles are carried by the current below the dam.

The escape device used in these dams was invented in 1845 by M. Kummer, the Chief Engineer of the Meuse Improvements in the Province of Liège. It is constructed in the following manner: The bar *M* (Fig. 81), supporting the tops of the needles between any two frames, is connected at one end by means of a collar to the hollow tube *D* bearing the up-stream end of the floor-axle in such a manner that it can turn horizontally when released. At the other end it rests (when locked) against a

circular post called a jack-post, placed inside the tube *D* of the next frame. A semi-circular notch is cut in the jack-post at the elevation of the support-bar. Similar notches are cut in the tube *D*, in which the jack-post is placed, and in the rear end of the collar of each support-bar, *M*. The head *H* of the jack posts, which projects out of the tube *D*, is made square to enable the dam-tender to turn it by means of a wrench or key. When the jack-post is turned so that its notch corresponds to that of the tube the support-bar of the needles becomes free and swings back horizontally, releasing the needles.

Needles are used only for the pass. The movable dam placed on top of the weir consists of 39 Chanoine wickets (page 327) each 7' 4" high by 4' 3" wide. A 4-inch space is left between two adjoining wickets. It may be closed by a board during low-water. The wickets are maneuvered from a frame foot-bridge placed on the up-stream side of the weir.

The Dam across the Big Sandy River at Louisa, Ky.,\* built in 1891 to 1897, is the first needle-dam constructed in the United States. It differs in several respects from similar works in Europe. It sustains a greater head of water, the needles are much wider and heavier, the trestle-frames are much lighter, and the methods of operating the dam are new. According to the original plans, needles were to be used for the pass and wickets for the overflow-weir, but it was finally decided to use needles both for the pass and weir. We believe that this is the first dam in which this arrangement has been adopted.

The works consist of: A lock 52 feet wide by 255 feet long, located on the right bank of the river; a navigable pass, next to the lock, 130 feet long, and an overflow weir 140 feet long, separated from the pass by a pier 12 feet wide and terminating at an abutment 17½ feet wide, on the left bank. The total length of the masonry foundation, including the lock, is about 400 feet.

The sill of the pass is about one foot below the low-water mark of recent years. The sill of the weir is placed 6 feet above that of the pass. The normal height of the pool is 13 feet above the sill of the pass.

The frames are placed four feet apart between centres. Those of the pass are 15' 2" high and 9' 10½" wide at the base. The weir frames are 9' 8" high and 6' 5" wide at the base. The weights of the pass and weir frames are respectively 1140 and 920 pounds.

The frames are made of 4-inch steel channels, the up-stream parts being single, while those on the down-stream side are made of two pieces, set apart and trussed as shown in Fig. 4, Plate DD. The posts of each frame are connected by two horizontal braces made of angle-iron. A suitable frame for carrying the floor is riveted to the outside of the main trestle-head.

The bar which connects two adjoining frames with each other when standing and supports the upper end of the needles is hinged vertically at one end at the pool level so as to swing horizontally. On the other end it is formed into a hook, on its up-stream side, which engages with a lip or projection on the next frame. A crank-

---

\* Paper on Movable Dams by B. F. Thomas, Trans. Am. Soc. C. E., June, 1898.  
Report of the Chief of Engineers, United States Army, 1897.

shaped rod, called a jack-post, serves for holding in place or releasing the hook end of the bar. When the dam is up this post is kept by a latch from turning. When the needles are to be released the latch is raised and the jack-post is turned by a wrench so as to allow the hook end of the bar to pass through the space formed by bending the post.

The frames are connected on top by a sheet-iron floor, which is hinged to and falls with them. They are also connected by the maneuvering chain.

The frames are raised or lowered by means of two chain-crabs—one for the pass and the other for the weir. The former is located on the lock-wall; the latter is situated on the pier. As the frames of the pass and weir are raised or lowered by their respective crabs in the same manner, we shall only describe the method of raising those of the pass. A chain which can be wound or unwound by the crab passes over all the frames and is attached to the one furthest from the crab. This chain passes, at each frame, over a combined chain and ratchet-wheel, which is attached to the head of the frame and turns on a horizontal axis. When the pawl is out of the ratchet the chain-wheel simply turns as the chain from the crab is moved, without producing any effect on the frame. When the pawl is dropped into the ratchet the chain-wheel is locked, and consequently any motion of the chain from the crab will revolve the frame on its journals. The chain passes at the crab over a sprocket-wheel and drops through a hole into a recess provided for it in the masonry.

**The Needles** are made of white pine. They are 12 inches wide. Those for the pass are 14'3" long, 8½" thick at the bottom and 4½" on top, each needle weighing when wet about 263 pounds. The needles for the weir are 8'3" long, 3½" thick at the bottom and 2½" at the top, each weighing about 80 pounds. All of the needles are banded at the top and bottom and are provided with iron handles at the top for convenience in handling. They have also suitable attachments for connecting-chains, for placing or removing them. Shallow grooves are cut in the sides of the pass-needles for strips of rubber, which may be placed in these grooves to prevent leakage. Thus far this has not been found necessary, the dam being remarkably tight.

The needles are placed by means of a boat on which those for the pass are stored when not in use.

**Method of Working.**—The following operations are required in working the dam:

- 1st. Raising or lowering the frames;
- 2d. Placing or removing the needles.

1st. *Raising or Lowering the Frames.*—Two men turning the crab and a third man to connect the frames, etc., can perform this work. When the frames are down the iron floor locks the pawls in the ratchet-wheels. Consequently, as the men at the crab wind in the chain the frame nearest the crab starts first to rise and others follow in turn. When the first frame is nearly vertical the attendant in charge of this part of the work raises the iron floor a few inches. The effect of this motion is to turn the pawl out of the ratchet, disconnecting thus the frame from the motion of the chain, which now simply revolves the chain-wheel. The attendant connects



Fig. 1.



Fig. 3.

NEEDLE-DAM ON THE BIG SANDY RIVER AT LOUISA, KENTUCKY.



Fig. 2.

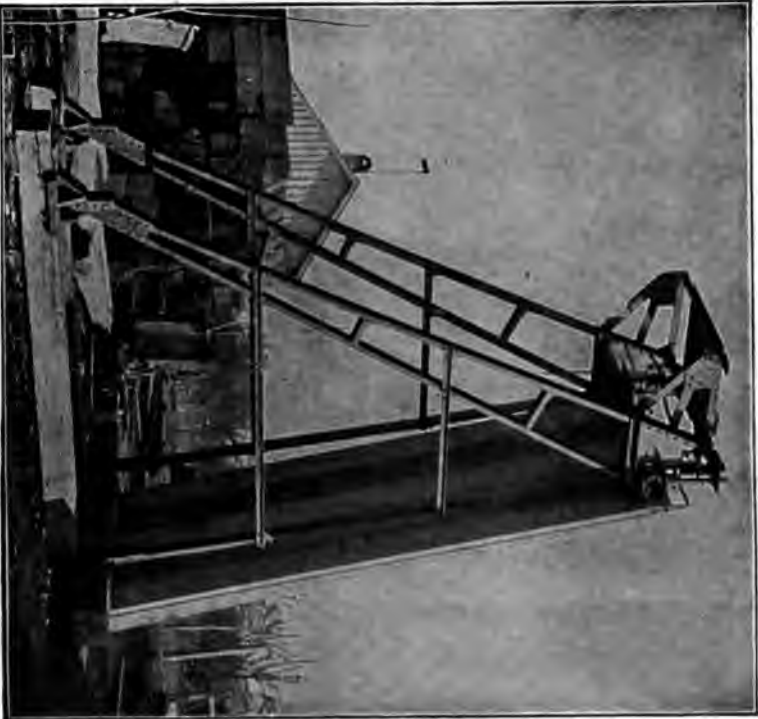


Fig. 4.



now this frame with the masonry by means of its floor and then places the connecting-bars. By the time he has performed this work the second frame has come within reach. This is stopped and connected to the first frame in the manner just described. The remaining frames are handled in a like manner. The iron foot-bridge is prolonged to the pier or abutment, as the case may be, by a rolling foot-bridge.

To lower the frames the work described is done in a reversed order. The attendant unhooks the rolling bridge and shoves it back into a recess provided for it in the masonry. He then disconnects the two frames furthest from the crab and unhooks the iron floor, which falls on the crab-chain, locking the pawl in the ratchet. The attendant pushes the last frame away from the crab while the chain is being unwound. When about 4 feet of chain have been unwound, the connections between the next two frames are removed and the pawl of the frame next to the one already being lowered is locked in the ratchet-wheel by dropping the iron floor on the crab-chain in the manner just described. This frame is pulled down by the weight of the one already descending, and so on. Several frames are usually raised or lowered at the same time, Plate DD, Fig. 1. The men at the crabs need not stop in the winding or unwinding.

Should the chain break, as has happened in the first working of the dam, the frames can be handled from the needle-boat.

2d. *Placing or Removing the Needles.*—This has been done in two ways: 1st, directly from the boat; 2d, from the water by means of a derrick on the boat. The first method was the one originally contemplated, but the second has been found by experience to involve less work.

When the first method is adopted the needles are handled by means of two trolleys travelling on suspended tracks, one on each side of the boat. In placing the needles every fourth one is first put in position in the dam. The intermediate needles are first placed on shelves, temporarily attached to the trestles just above the water. When all the remaining needles are placed in this manner, each shelf is revolved to a vertical position by pulling a trigger. The needles, left without support, drop into the water and are guided to their proper position by the turned shelf behind them and the needles already placed. The revolving shelves are then removed.

When a rise occurs in the river, some relief may be given by opening the gates of the lock and by pushing out the heads of alternate pins, supporting them by sticks 12 to 15 inches long, placed between them and the support bar. If these measures are insufficient to keep the water from rising, the needles of the pass or of the whole dam may have to be removed.

According to the original intention the needles were to be released in the usual manner by turning the jack-posts. It was feared, however, that owing to their weight the needles might get more or less injured when released, especially those falling over the weir. Another method of removing the needles was therefore adopted. Each needle is provided on top with a counter-sunk handle. A chain much longer than the dam is passed along the up-stream side of the needles and connected by hooks with their handles so as to have a considerable amount of slack chain between each pair. A long line is connected to the end of the chain. It can be wound up either

by the engine of the boat or by a crab on the lock-wall or on shore. As this iron is wound up the needles are pulled in succession out of their place in the dam. This method works very rapidly and satisfactorily.

**Drift-boom.**—After severe storms the river carries a considerable amount of drift, which may injure the dam and interfere with its being lowered. To avoid this danger a drift-boom, consisting of four parallel timbers bolted rigidly together and having rudders at intervals of 30 feet, is placed across the river from a point some distance above the lock to the crib at the river-wall of the lock. As the river makes a sharp bend at the point of attachment the boom forms a continuation of the shore. It serves to guide the drift into the lock, where it can be held or let through as desired. The rudders are all controlled by a wire rope which connects them all and is wound on a capstan at the end of the boom. By setting the rudders at any desired angle the boom can be held out in the stream at any point required.

**Cost.**—The total cost of the dam, including the pass, weir, pier, and abutment, amounted to \$73,697.74, or \$245.66 per lineal foot. The substructure cost \$226.48 and the superstructure \$19.18 per foot.

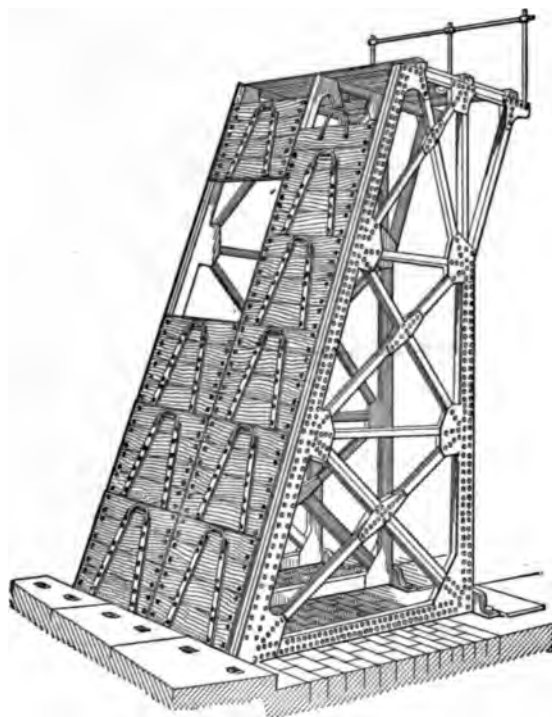


FIG. 82.—BOULÉ GATE.

**Boulé Gates** (Fig. 82).—In 1874 M. Boulé introduced a modification in a Poirée dam by substituting for the needles ordinary plank sluice-gates, a number of gates, placed one on top of another, being used in each bay. Each of these gates consists of a number of boards, tongued-and-grooved, and bolted together. They slide vertically between the frames and are maneuvered by a derrick travelling on top of the foot-bridge. In order to limit the transverse strains, to which the gates are subjected, the distance between the frames should not exceed one meter. Thicker boards are used for the lower gates than for



those placed at the top. For convenience in regulating the height of the pool, the upper gates may consist of single planks which can be readily placed or removed by hand.

While the first cost of a frame-dam with Boulé gates is about the same as that of a needle-dam, the former has the following advantages over the latter:

- 1st. It forms a tighter dam, as it has fewer joints.
- 2d. It can be more correctly proportioned to the water pressure to be resisted, thin planks being used for the upper and thick planks for the lower gates.
- 3d. It reduces the spans of the wooden members greatly, by placing them horizontally between the frames.
- 4th. It can be used for deeper pools.
- 5th. The service-bridge can be placed at a higher level above the water.
- 6th. No weir is required, as the whole dam forms an overflow.
- 7th. The level of the pool can be easily regulated.
- 8th. The dam is more easily maneuvered and with less danger.

On the other hand, it must be stated that a needle-dam can be opened much more rapidly than a Boulé dam, as constructed at present.

Compared with a dam of Chanoine wickets, Boulé's system is found to be considerably cheaper and less complicated.

By removing in succession each row of Boulé gates across the whole dam, the pool is lowered gradually and the work of raising the gates is greatly reduced. This method of maneuvering consumes, however, considerable time, 5 to 6 minutes being required for raising

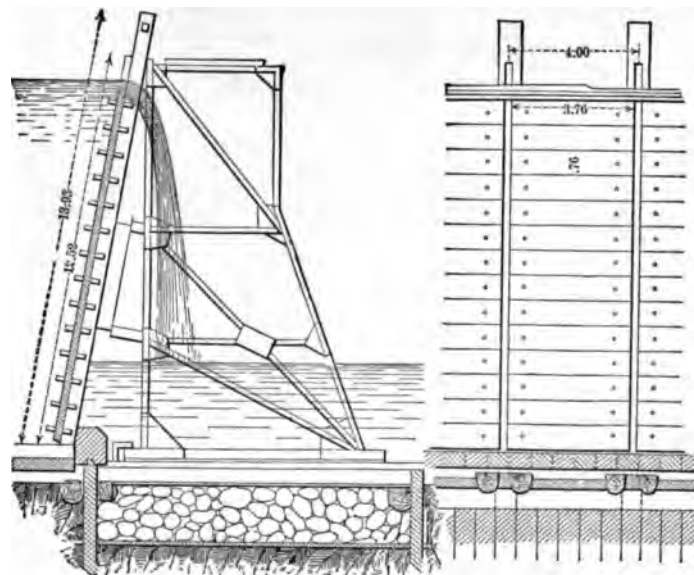


FIG. 83.—BOULÉ GATES IN MOSKOW DAMS.

one of the gates of the lowest tier. This objectionable feature might be removed by introducing some system of escapement.

Boulé gates were first used in France in the regulating portion of the Mulatière dam across the Saône, near Lyons. They have since been successfully used in the dams at Suresnes, Marly, etc.

This system was applied by M. Janicki, in 1876, in six dams on the river Moskowa, in Russia. According to the original plans, these dams were to be provided with needles 7

inches square. As the engineers had some doubts about being able to work needles of that size, they adopted Boulé's system, which had just been proposed, with some modifications. Instead of gates, planks about 10 inches wide are used, which bear against upright timbers resting against a sill and the top of the frame like Poirée needles (Fig. 83). Two pegs are put through every plank, one at each end. They bear on the down-stream side against

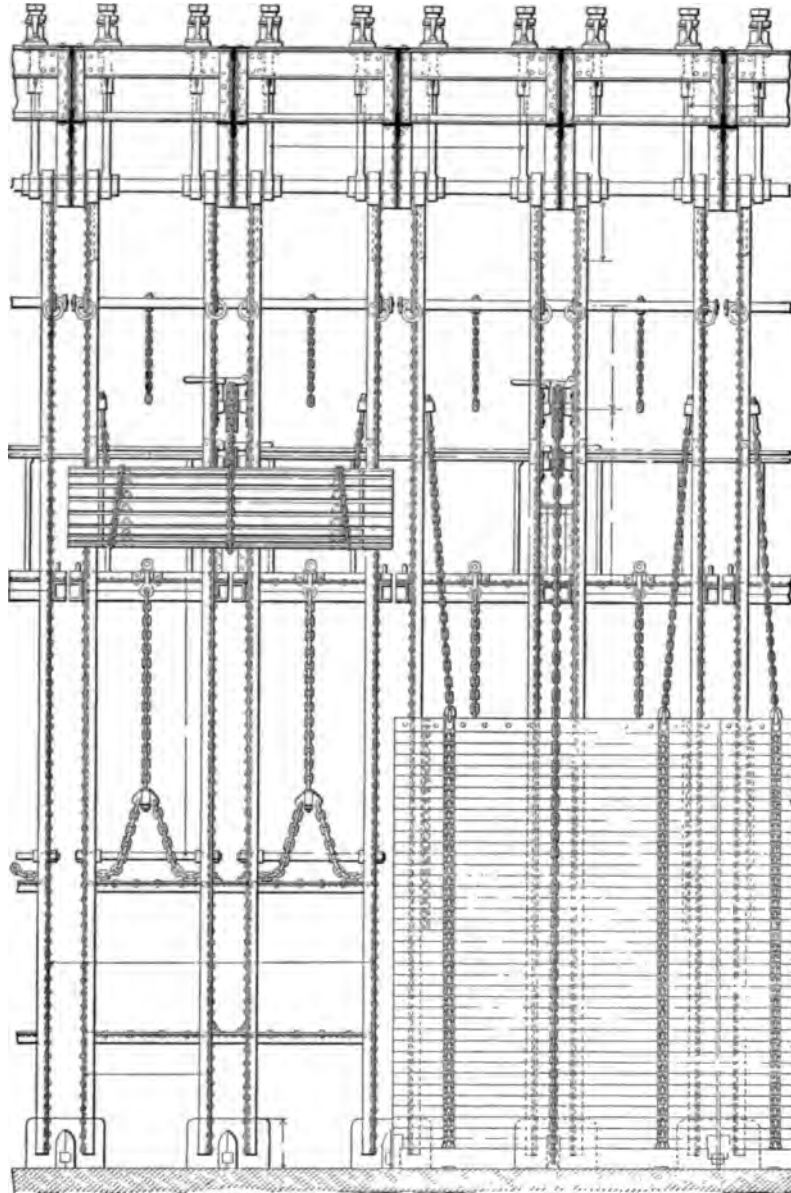


FIG. 84.—CAMÉRE CURTAIN-DAM.

the upright timbers, and serve as guides for the planks. On the up-stream side they form the handles by which the planks are raised, by means of hooked poles, no crab being required. The objection to the time consumed in maneuvering dams arranged according to Boulé's system applies also to the Moscow dams, but it would seem that in this case an arrangement for permitting the planks to escape might be readily contrived.

**The Curtain-dam**, invented by M. Caméré, was first introduced in 1876-80 in the Port



Villez dam (page 319). Having stood this test very successfully, it was used later on in the Suresnes, Poses, and Port-Mort dams (pages 319 to 323). M. Caméré's invention consists in the substitution of a wooden curtain that can be rolled up from the bottom, for the needles in a Poirée dam.

Figs. 84 to 88 show the construction of the curtains, etc., of the Poses dam,\* which are called "double," as each of them covers two bays of the dam. In the other two dams mentioned above, a curtain is provided for every bay. Each curtain consists of a number of horizontal wooden bars, which are fastened together on the up-stream side by two rows of bronze hinges (Fig. 86). The bars have the same length and height, but their thickness is increased from the top to the bottom, according to the pressure they have to sustain. A casting called the "rolling-shoe" is attached to the bottom bar and forms the centre on which the curtain is rolled up. It rests on the floor when the curtain is down. The base of the shoe forms half the spire of an Archimedian spiral, which is completed by three

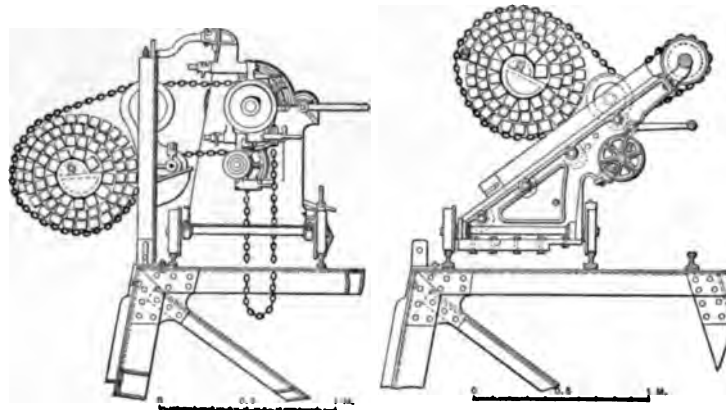


FIG. 87.

flanges which surmount the upper plane surface of the shoe. The weight of the "rolling-shoe" is sufficient to make the curtain unroll easily when it is being lowered.

The curtain is suspended by two chains which are fastened by hooks to the fixed parts of the dam, above the water. Each of these chains is attached to a ring bolted to the upper bar in the line of the hinges.

The curtain is moved by means of a special windlass (Fig. 87), which works an endless chain that passes around the curtain on its centre-line. The chain is prolonged above the curtain and is guided to the windlass by fixed pulleys. The windlass is arranged in such a manner that when the curtain is being rolled up, the up-stream part of the windlass-chain, which rises, travels faster than the down-stream part, which is lowered. This difference of velocity causes the chain to slide under the shoe. The resulting friction added to the traction of the chain makes the shoe revolve, and thus rolls up the curtain. In unrolling the curtain the down-stream part of the chain is made fast and the up-stream part is released. If the curtain is properly suspended it will move between two vertical planes. It is, however, advisable to have guides to prevent any lateral motion which might be caused

\* Figs. 84 to 88 are taken from Dr. William Watson's official report to the U. S. Government on "Civil Engineering, Public Works, and Architecture at the Paris Universal Exposition of 1889."

by faulty construction or regulation. These guides are usually formed of angle-irons which are attached to the frames.

The hooks of the chains by which the curtain is suspended are fastened to a special iron frame (Fig. 87), which is secured to the bridge of the dam by pins. When the curtain is to be removed, after being rolled up, it is placed with the frame from which it is suspended, on a special car (Fig. 87) running on the bridge track. After being taken out of the dam, the curtains must be hung up to dry, and cleaned.

With the Caméré system of movable dam a special weir is not required, as no damage can result from the water passing over the top of the curtains. The upper

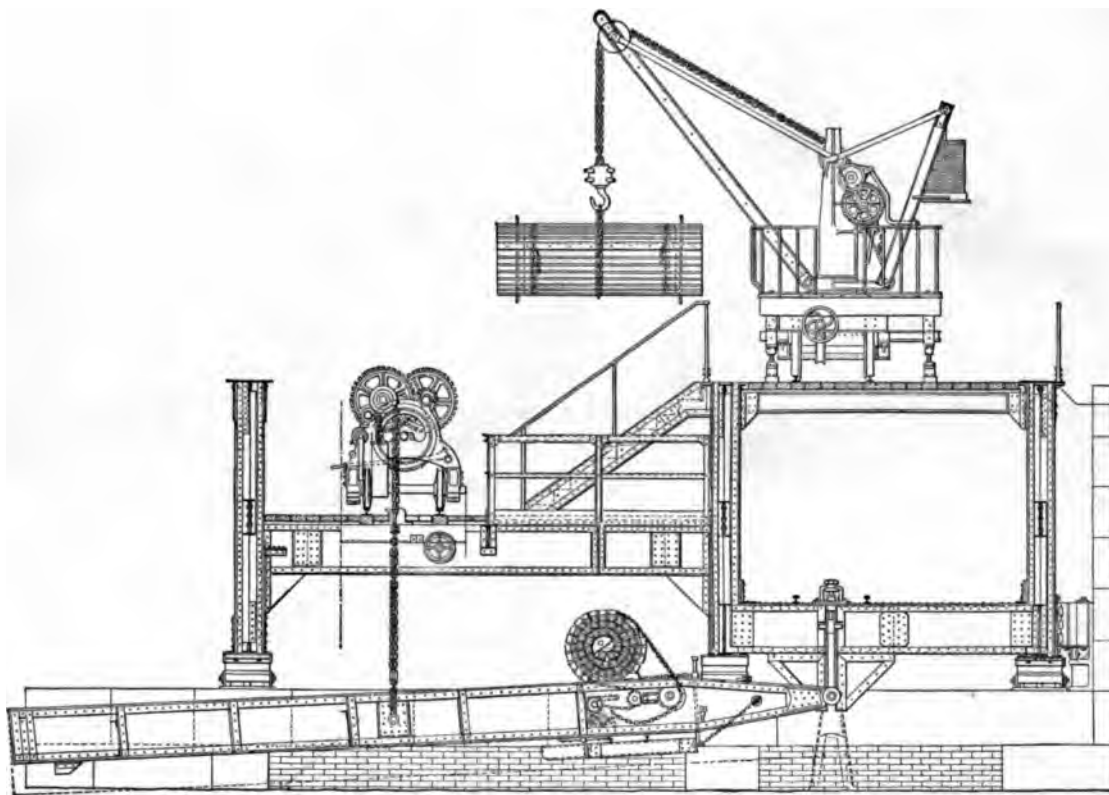


FIG. 88.—CROSS-SECTION OF CAMÉRE CURTAIN-DAM.

pool can be drawn down by rolling up the curtains to any desired height. As the water is thus discharged from the bottom of the pool, no difficulty is experienced with drift, but on the other hand, it involves the objectionable feature that scour is produced at the bottom of the curtains when they are raised. The Caméré curtains have now stood the practical test of fifteen to twenty years' service in the dams of Port Villez, Poses, Suresnes, and Port-Mort.

The Port Villez Dam was constructed in 1876-80 across the Seine at a point about 90 miles below Paris, to obtain a depth of  $10\frac{1}{2}$  feet for navigation. It is 700 feet long and consists of two central navigable passes and a regulating weir on the right bank, which are separated by two piers. The sill of the passes are 13.12 feet below the upper water-level; the sill of the weir is at half this depth.

The original plans contemplated the construction of a Poirée dam with needles 8 inches square, which were to be handled by mechanical means. Thus far this system had only been applied to lifts of about  $6\frac{1}{2}$  feet. As M. Caméré, the engineer who designed and constructed the works under the direction of M. Lagrené as Chief Engineer, had some hesitation of using needles for the great lift required in the Villez Dam, he invented a hinged wooden curtain (page 316), which he used with Poirée frames, both in the passes and in the weir.

The frames are placed 3 feet  $7\frac{1}{2}$  inches apart. Those for the passes are 18 feet high and weigh each 4181 pounds. The weir frames are 9 feet 2 inches high, and weigh 798 pounds apiece. The frames are designed to present as little obstruction as possible when lowered. They lie in a recess in the masonry apron when down. The up-stream posts have a small "T-iron" on their face, the web of which serves as a guide for the bars of the curtains. The service-bridge is widened sufficiently to carry two tracks, by means of brackets on the down-stream side of the frames. The rails act as the braces for the frames and replace the connecting bars used in the older types of frames.

The frames are raised or lowered by means of a windlass which is placed on a car that travels on one of the tracks of the service-bridge. The lowering of the heavy frames of the passes is a troublesome operation. Numerous breakages and deformations of the frames, caused by their striking on stones, stumps, etc., brought down by the floods, have occurred.

The **Poses Dam** on the Seine, about 125 miles below Paris, was constructed to replace an older movable dam. The work was completed in 1885. The dam, which extends from the left bank of the river to the point of an island (Fig. 89), has seven

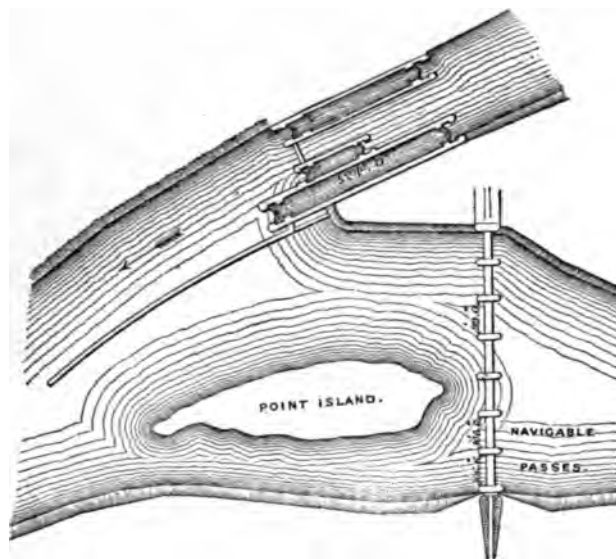


FIG. 89.—POSES DAM.

openings which are separated by piers. The two openings at the left bank, serving as navigable passes, are each  $106\frac{1}{2}$  feet wide; the others have each a width of 99 feet. The sills of the navigable passes and of the three passes nearest the island are 16.42 feet below the upper water-level. The two central openings have their sills  $6\frac{1}{2}$  feet

higher than those of the other passes. The locks are located between the island, at which the dam terminates, and the right bank of the river.

On account of the great height of the dam, the foundation across the whole river was carried down to an impermeable stratum of chalk, at a depth of about 28 feet below the sills of the navigable passes. The piers (Fig. 90) are 13.12 feet

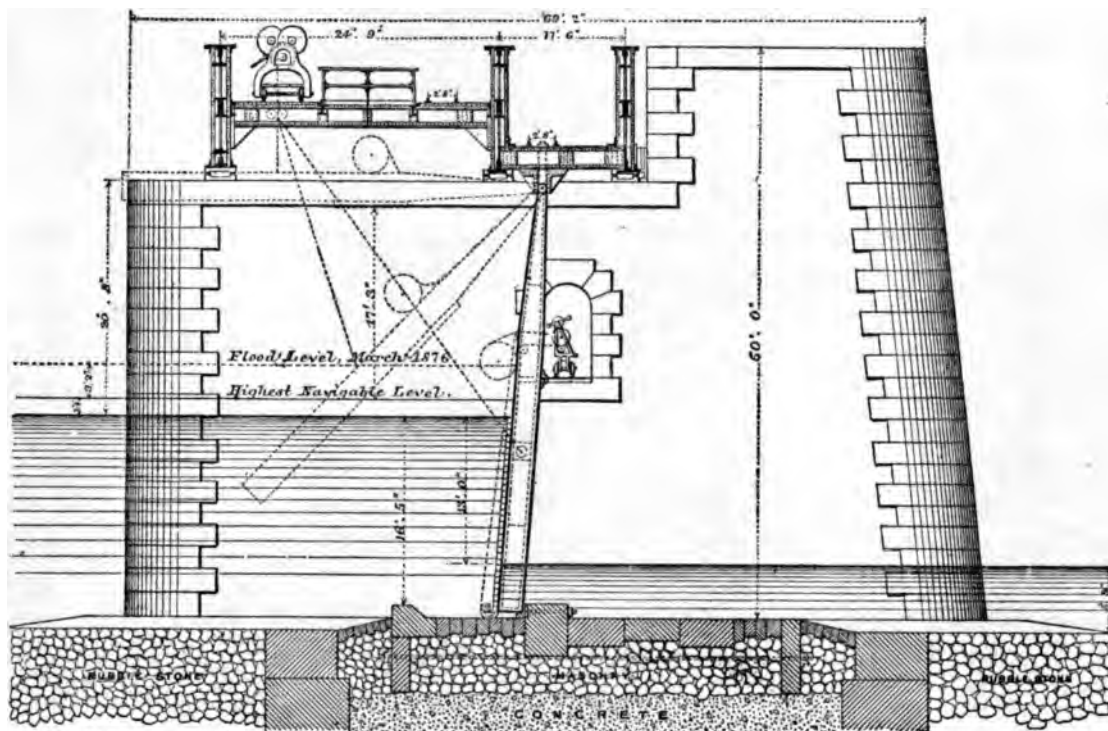


FIG. 90.—PIER OF POSES DAM.

thick. Full-centred arches, 4.26 feet wide and 7.54 feet high, are constructed in the piers and abutments to permit the service-bridge to pass through them.

On account of the trouble experienced in handling the heavy Poirée frames of the Villez dam, mentioned above, M. Caméré, who designed and constructed also the Poses dam, decided to use in the latter, frames suspended from an overhead bridge. When down, these frames bear against a sill and form the support for the Caméré curtains. When the dam is to be opened, the curtains are first removed, and then the frames are hoisted out of the water, so as to lie in a horizontal position below the bridge. A similar arrangement of suspended frames was suggested by M. Tavernier for the Saône in 1873, but was not carried out. While this system has the advantage of removing the whole dam from the water when the passes are to be opened, it necessitates a high service-bridge and, consequently, long frames, if vessels are to pass under the bridge during floods.

A wide bridge is constructed across the whole dam. It is composed of three lines of longitudinal lattice girders connected by cross-girders. The longitudinal girders divide the bridge into two parts at different elevations (Fig. 88); one supporting the upper, suspended ends of the frames and carrying the derrick used in removing

the curtains; the other supporting the windlass for hoisting the frames out of the water.

Each curtain in this dam is 7.47 feet wide and closes two bays. It is composed of yellow-pine bars 0.25 feet high, having a slight play between them to allow for swelling. The thickness of the bars varies from 1.57 inches at the top to 3.54 inches at the bottom of the deep bays. The upper bar is reinforced by an angle-iron, as it is exposed to shocks from floating bodies. The curtains, when rolled up, are not removed from the frames unless they require repairs. Even when the frames are hoisted up, the curtains remain attached to them. In one of the deep passes a curtain can be rolled or unrolled in about fifteen minutes. The raising and lowering of a frame requires, respectively, twenty and ten minutes.

**The Dam at Suresnes**, a short distance below Paris, was originally constructed for Poirée needles. In 1884 it was reconstructed in order to raise the level of the pool  $3\frac{1}{4}$  feet, to secure a minimum depth of  $10\frac{1}{2}$  feet of water. In building the new dam M. Boulé, the Chief Engineer in charge of the work, decided to use both the gates invented by him and Caméré curtains, in order to test the two systems side by side. At the site of the dam two islands divide the river into three channels, Fig. 91. A weir 206 feet wide was

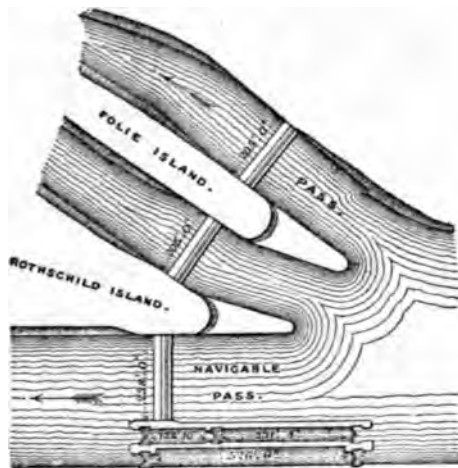


FIG. 91.—SURESNES DAM.

built in the middle channel, and passes respectively 206 feet and 238 feet wide were constructed in the right and left channels. The sills of the right pass, weir, and left pass were placed respectively 12.13, 16.25, and 17.90 feet below the level of the upper pool. A lock 525 feet long and 56 feet wide is constructed at the left bank.

The weir is closed by Boulé gates, Fig. 82, page 314. Caméré curtains are used in the right pass. In the left pass, which is the principal channel for navigation, Caméré curtains and Boulé gates alternate. The curtains and gates are supported by Poirée frames. Those of the main pass are 19.5 feet high and weigh each about 4000 pounds. Each of the curtains used in this pass weighs 1600 pounds.

The frames are maneuvered by means of a Megy patent windlass, which is placed on the abutment. A continuous chain unites the frames by means of link catches placed on their upper cross-braces. The portion of the chain between any two con-



secutive frames is longer than the distance between their centres. As the chain is wound up several frames are moved at a time, like the sticks of a fan. This system is similar but not as good as that used in the Louisa Dam, described on page 309. At Suresnes seven men can open a pass of 238 feet, containing 57 frames, in three hours and can raise it in five. At Louisa three men can raise a frame and place the foot-bridge in about a minute.

The Port-Mort Dam was constructed in 1886 across the right branch of the Seine, between the Port Villez and Poses dams. It has seven passes of 99 feet width, which are separated by piers 13 feet wide and are closed by Caméré curtains. The dam is very similar in design to that at Poses, except in some minor details of construction. Owing to the much greater height of the navigable level above the normal level, the piers of this dam are higher and its frames are longer than those of the Poses dam. In both of these dams a clear headway of  $16\frac{1}{2}$  feet above the highest navigable level is provided when the frames are raised.

**A-Frame Dams.**—This style of movable dam was invented by B. F. Thomas, M. Am. Soc. C. E. It consists of a number of A-shaped trestles or frames (Fig. 92) adjoining each other so as to form a sufficiently tight dam. The legs of each frame are fastened

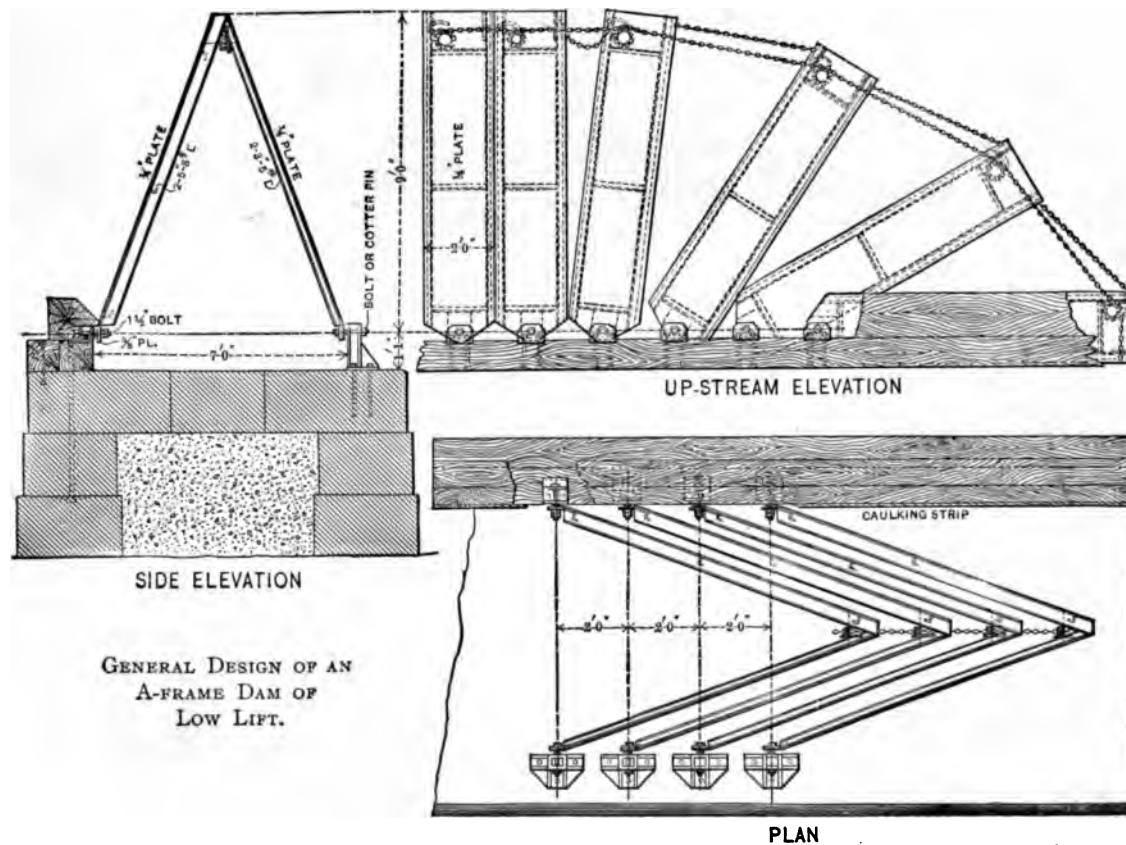


FIG. 92.—THOMAS A-FRAME DAM.

together at the top by plates 18–30 inches wide, which form a walk on top of the dam. To the lower end of each leg a piece having an eye is riveted, the piece being bent so as to make the eye vertical. A pin passes through this eye and connects the leg to a journal

box, which is fastened to the floor of the dam. To enable the frames to turn without binding, the eye of the journal box must be centred at a greater distance from the floor than half the width of a frame. The up-stream box is embedded in the sill or may form part of it.

The up-stream legs of the frames are made of channels to which plates are riveted. A space of about  $\frac{1}{8}$  inch may be left between the adjoining frames, when erected, to prevent fouling when the dam is operated. The small amount of leakage between the plates would serve to flush out the bed between the legs. The down-stream legs may be constructed like those on the up-stream side, or they may be latticed or made of single members.

The frames may be raised or lowered by a maneuvering chain which is wound around a winch placed on the pier or wall at one end of the movable dam, and attached to the frame furthest removed from the winch. The chain passes over sprocket-wheels, one being placed on a shaft at the head of each frame. Each of these wheels has on one edge a ratchet, into which the tooth at one end of a pawl fits loosely, while the other end forms a rounded wedge. The pawl is pivoted so as to be readily lifted out of the ratchet when the wedge end is depressed. This occurs, just as the frame becomes vertical in raising, by the wedge end being pushed by a projection on the adjacent frame, made for this purpose. The wheel on top of the frame is thus enabled to run freely, but if the frame should begin to descend the pawl would become locked in the ratchet and the frame would be raised again. The pockets in the wheel are made to fit the maneuvering chain, which cannot move without also moving a trestle so long as the pawl is in the ratchet.

In addition to the maneuvering chain short pieces of chains may be placed between adjacent trestles and fastened to them by eye-bolts. The length given these short chains (called fixed chains) depends on the number of frames that are to be raised at a time, or, in other words, upon the power of the winch; they must, however, be sufficiently long to permit the frames to lie flat when down. When lowered the frames are protected by the sill of the weir or pass.

Instead of a chain-wheel and pawl a latch, placed and removed by hand, may be used.

The advantages claimed for this style of dam are:

1. Simplicity of construction and operation.
2. Cheapness of construction, as only a narrow foundation is required.
3. Little leakage.
4. The dam can be operated under great heads of water by two or three men, as it is raised or lowered across the current.

A weir of this kind, 120 feet long and 13 feet 2 inches high, forms part of Dam No. 6 on the Ohio River, which was completed in the fall of 1904.\*

---

\* See page 365.

## CHAPTER II.

## SHUTTER-DAMS.

**Early Shutter-gates.**—For some centuries gates turning on horizontal axles, placed near their tops, have been used in Holland to let the interior water from rivers and canals escape into the ocean at low tide while preventing the water from the sea from entering at high tide. Such a gate having its axle placed at one-third its height from its base, which corresponds to the centre of pressure when the water rises to the top of the gate, was proposed by M. de Cessart, in a "Description of Hydraulic Works," printed in 1808. M. Petitot suggested, in 1825, a similar gate for regulating automatically the level of a stream of water.\* In a memoir on establishing internal navigation between Paris and Rouen, M. Frimot proposed, in 1827, placing in fixed dams several gates, one on top of the other, each turning on a horizontal axis. The turning of these gates was to be controlled by floats.

In 1837, shutters turning on horizontal axles were placed under the bridge of Riom (France). † These gates opened automatically during freshets and had to be set up again by hand.

The first dam constructed by movable shutters was probably the one across the river Orb (France), described by Delalande in his "Traité des Travaux de Navigation," published in 1778. This dam was raised 3 feet by movable wooden shutters hinged to the top of the dam and held by props placed on their down-stream side. The sluice-openings were closed by stop-planks (poutrelles) placed horizontally, one on top of another, and attached to each other by chains. When the water was to be lowered these stop-planks were allowed to escape by a suitable contrivance and the shutters on top of the dam were lowered by hand when the water had subsided sufficiently.

**Thénard Shutters.**—M. Thénard applied the movable shutters just described, with some improvements, on several dams on the river l'Isle (France). He found that the height of these dams, 6.56 feet above low water, while insufficient for internal navigation, caused inundations in times of freshets. To avoid this trouble M. Thénard determined to reduce the height of the fixed dam to 3.93 feet above low water, and to obtain the remaining height required for navigation by means of movable shutters similar to those placed on the crest of some of the dams in the river Ord. He used this construction for the first time in 1831 in the dam of Saint-Seurin. The principal improvement which M. Thénard introduced was a tripping-bar, by means of which the props could be "tripped" in succession, allowing the shutters to fall down. The end of this bar consisted of a rack, which could be moved by a pinion placed in a well in the abutment.

---

\* *Mémorial du Génie*, for 1825, Vol. VII., page 161.

† *Annales des Ponts et Chaussées*, for 1842, 1st Series, page 231.

While the device just described made the lowering of the dam a very simple operation, much difficulty was encountered in raising it against the current. To obviate this trouble, M. Mesnager advised M. Thénard to place counter-shutters falling up-stream above the remaining shutters. The former were to be raised by the current itself and to be kept by stop-chains from rising too high. This plan was carried out successfully on three dams built on the l'Isle in 1839-1841. Each of these dams was 230 feet long, including the pass and lock. The shutters were bolted to a wooden sill which was fastened to the top of the masonry dam. They were 6.56 feet wide by 3.28 feet high. Those falling down-stream were supported, when up, by wrought-iron props, whose feet bore against iron hurters (shoes) or sills. The iron tripping-bar was moved by turning a pinion on the river bank in the manner already explained. It had a projection for every prop. For every  $1\frac{1}{8}$  inches of motion it tripped one shutter. After all the shutters were lowered the tripping-bar had to be moved back to its original position.

The up-stream shutters, when lowered, were held in place by spring-latches, which could be released by a tripping-bar. A forked chain, fastened to the floor, kept each shutter from rising above a desired point. When these shutters were up the lock-keeper could walk almost dry-shod on the weir and raise the down-stream shutters by hand. When both sets of shutters were up he equalized the level of water between them by opening small valves in the up-stream shutters. He finally pushed the counter-shutters down with a pole. The whole operation of raising one of these dams could be performed by one man in about sixteen minutes.

In 1843, M. Thénard erected at the St. Antoine Dam shutters 5.57 feet high by 3.82 feet wide. In this case he constructed a small sheet-iron foot-bridge on top of the counter-shutters, from which the tender could raise the down-stream shutters.

Having applied movable shutters 5.57 feet high successfully, M. Thénard obtained, in 1846, authority to carry out his system on the Seine near Montereau. According to a memoir which he prepared he intended, in this case, to use shutters 7.54 feet high by 5.08 feet wide, and counter-shutters 7.04 feet high by 5.02 feet wide. The apron was to have a length of 36 feet. Some improvements were to be introduced in the manner of releasing and lowering the counter-shutters. The main shutters were to be raised from a boat. Before he could carry out his project M. Thénard was put on the retired list. His successor, M. Chanoine, introduced several modifications before such a dam was actually built in 1850 across the Seine at Courbeton.

Although Thénard's system of movable dams has been used successfully, the counter-shutters form rather an objectionable feature. The stop-chains, their attachments, and the hinges of these shutters are subjected to great strains when the shutters are suddenly stopped at the proper height. Breakage of these parts at any one shutter delays the erection of the whole dam. It has also been found difficult to make the temporary dam, formed by the counter-shutters, sufficiently tight.

Thénard shutters have been used, with some modifications and improvements, on dams in India.\* In the Mahanuddec Dam (Fig. 93) ten openings, 50 feet in width,

\* "Movable Dams in Indian Weirs," by R. B. Buckley, Minutes of Proc. Inst. C. E. for 1880, Vol. LX., p. 44. Fig. 93 is taken from this paper.

are each closed by seven pairs of shutters, those falling down-stream being 9 feet high. In the Sone Dam sixty-six openings,  $20\frac{1}{2}$  feet wide, are each closed by a single pair of shutters, those on the down-stream side being  $9\frac{1}{2}$  feet high. To regulate the rising of the counter-shutters, and to avoid the heavy shocks to which they would be subjected if stopped suddenly, hydraulic brakes are attached to their up-stream side. Each of these brakes consists of a cylinder full of water, in which a piston, moved by the shutter in rising, travels. A number of small escape orifices for the water are made in the

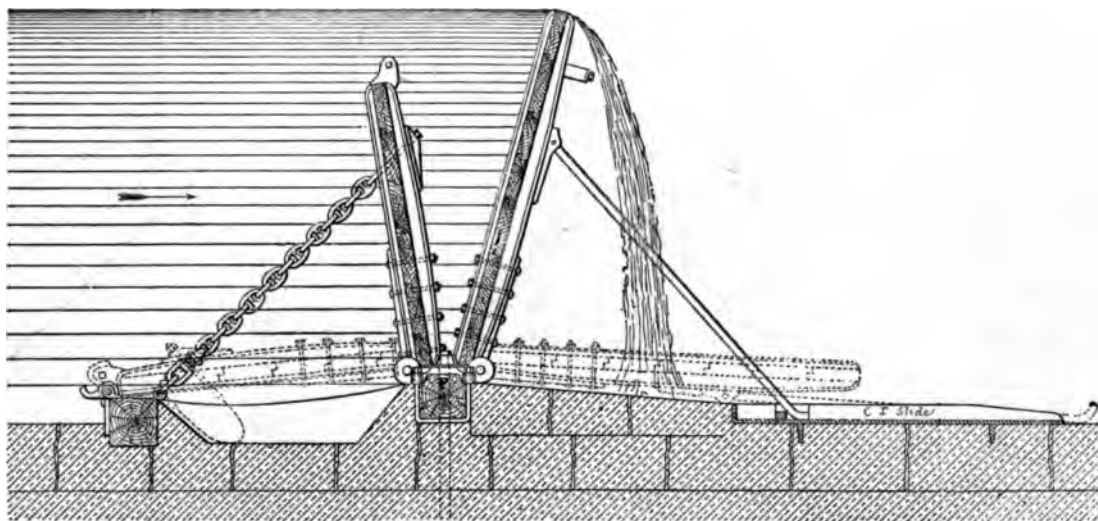


FIG. 93.—THÉNARD SHUTTER-DAM.

cylinder and arranged in such a manner that the vent of the water is diminished as the piston rises, and the checking force of the brake, therefore, is increased.

**Chanoine Wicket-dam.**—The objection to counter-shutters mentioned above induced M. Chanoine to substitute for them in the Courbeton Dam across the Seine a Poirée needle-dam, which serves to hold back the water while the shutters on the weir are being raised and furnishes a bridge from which this operation can be performed. There still remained, however, the difficulty of raising the last shutter on the weir on account of the leakage through the needle-dam. In 1852, M. Chanoine overcame this difficulty by raising the axle of the shutter to a point between one-third and one-half of its height, and supporting it on a horse or trestle which itself could revolve on an axle fixed on an apron of the dam when the prop was withdrawn. This invention was carried out practically for the first time in 1857 in the dam of Conflans, on the Seine. Another engineer, M. Carro, appears to have invented a similar shutter about the same time.

The term "wicket" has been applied in the United States to a shutter revolving on an axle placed near its middle. Described in detail, a Chanoine wicket consists of three parts (Figs. 94, 95, and 96): A rectangular panel of wood or iron; the horse, or trestle, supporting the axle of the shutter, and the prop holding up the horse and having its foot bearing against a cast-iron shoe, called a "hurter" (in French "heurtoir") fixed to the apron. The parts of the shutter above and below the axle

are called respectively the "chase" and the "brech." Two maneuvering chains are usually attached to the shutter, one to the top and the other to the bottom.

Several wickets, placed side by side, form the dam. To prevent the panels from interfering with each other by swelling, etc., they are placed about 2 to 4 inches

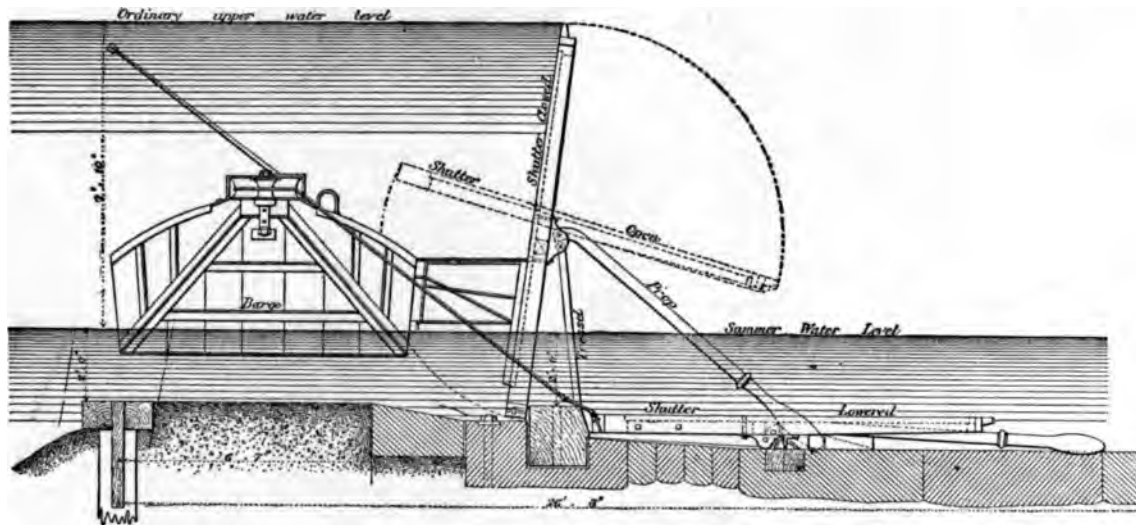


FIG. 94.—CHANOINE SHUTTER-DAM ON NAVIGABLE PASS ON THE UPPER SEINE.

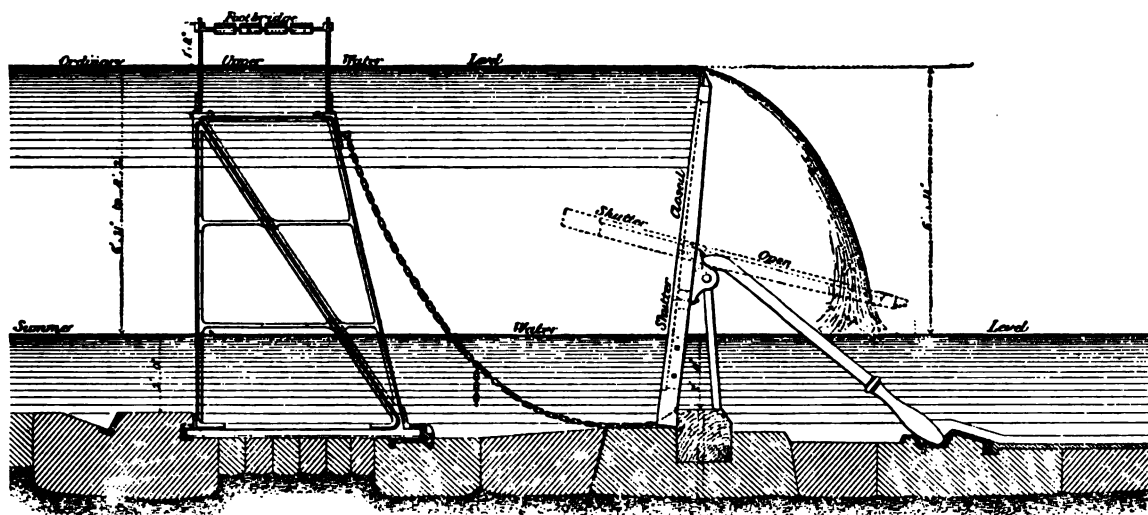


FIG. 95.—CHANOINE SHUTTER-DAM ON NAVIGABLE PASS ON THE MARNE.

apart. When the leakage between the wickets is greater than the minimum flow in the river the spaces between the wickets can be closed by needles or by nailing strips of wood to the shutters.

The axles of the weir-wickets are placed so that they will revolve automatically when the water reaches a certain height, but those of the pass are attached at the centre of the shutter. The pass wickets do not oscillate, therefore, when the water rises. They can be readily lowered by the tripping-bar when required. When the prop is tripped by moving it sideways, it slides forward on a casting joined to the hurter, called the slide, and is

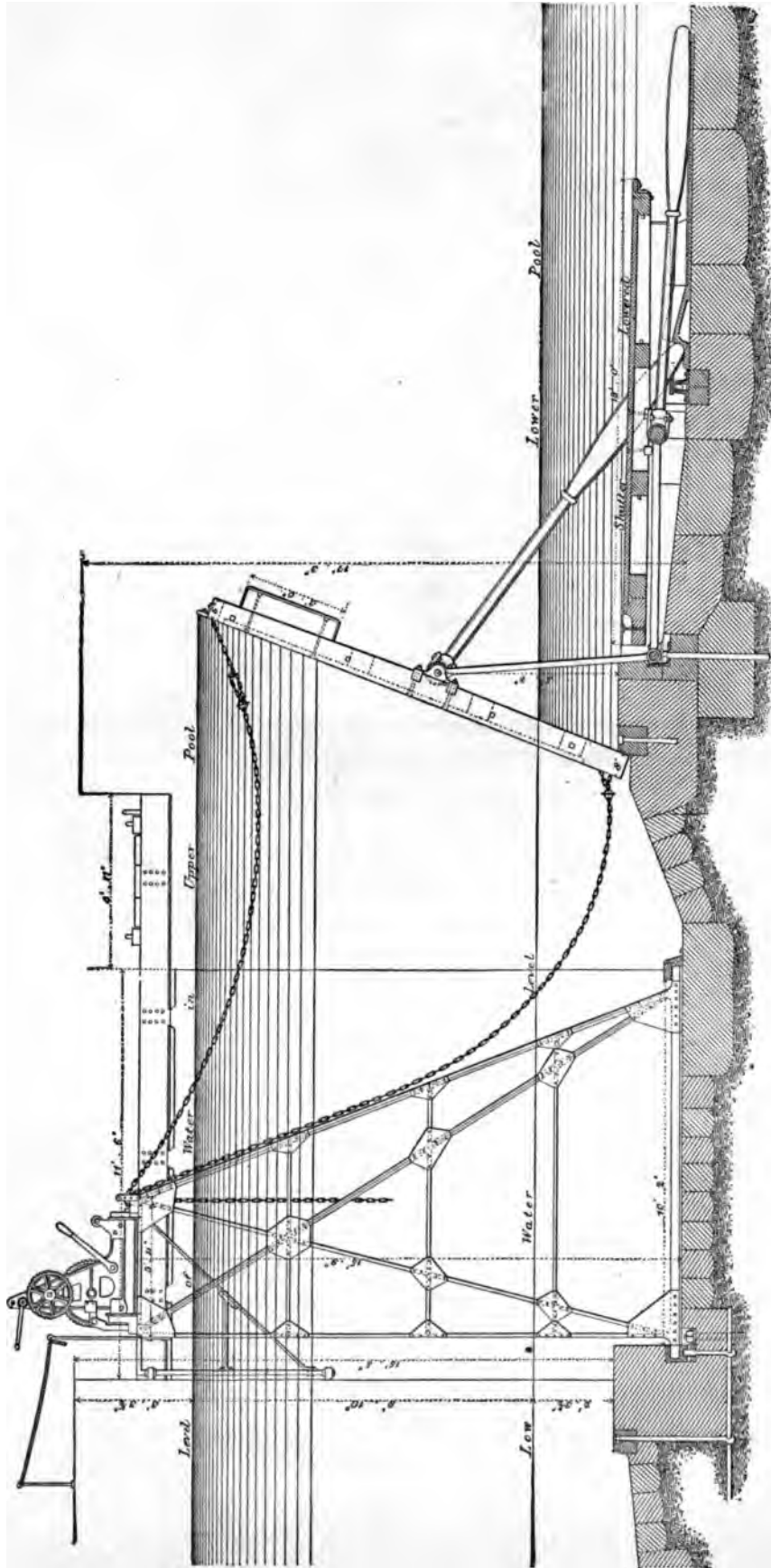


FIG. 96.—CHANOINE SHUTTER-DAM FOR NAVIGABLE PASS OF PORT A L'ANGLAIS WEIR ON THE UPPER SEINE (CONSTRUCTED IN 1870)

followed by the horse. The shutter falls on top and covers them. This method can only be used, of course, when there is sufficient water on the apron to act as a cushion. If the water on the apron is not deep enough for this purpose the fall of the wicket must be broken by means of the maneuvering chains.

The tripping-bar moves horizontally on the apron. It has a projection for each prop. They are placed in such a manner that at first only one prop is tripped at a time, then two, and finally three or four. By this arrangement the pool is drawn down gradually and the effort required in moving the tripping-bar is reduced.

As the tripping-bar must be pulled back to its original position when the dam is down, it must either be placed in a special channel on the apron or the tops of the props must be curved at the top as shown (Fig. 95), in order not to interfere with the tripping-bar when they are down. The tripping-bar is sometimes placed on rollers to facilitate its motion. One end of the tripping-bar is formed by a rack which engages with a pinion fixed on a vertical shaft and placed in a well built in the masonry of the abutment.

To raise the dam each wicket is brought to a horizontal position, or, as it is called, "put on the swing," by pulling the breech-chain from the service-bridge or a boat until the horse is up and the prop has fallen into its resting-step. If the breech-chain is pulled up too much there is some difficulty in afterwards raising the wicket to its vertical position. To avoid this trouble lugs are sometimes cast on the horse to confine the position of the wicket within  $15^\circ$  of the horizontal, when on the swing. When a foot-bridge is provided there is, however, no difficulty in raising the wickets by means of the two maneuvering chains and the lugs on the horse are omitted, as they have some disadvantages. After the wickets have all been brought to the swing, in which position they offer very little resistance to the current, they are rapidly raised by pulling the chase-chains until the wickets strike against the sill. When in position in the dam they are inclined about  $20^\circ$  from a vertical plane. Movable counter-weights are sometimes attached to the wickets to assist in raising them.

In some Chanoine wicket-dams no service-bridge is provided, the maneuvering being done entirely from a boat. In others a foot-bridge is used only for the weir, the pass-wickets being maneuvered by means of a boat. In each of these cases the details of maneuvering differ slightly from the manner we have described. Thus, when a boat is used for the weir and the pass, the wickets of the former are first put on the swing, but those of the latter are erected at once. In the dams built in 1860 on the upper Seine and Yonne a boat was used for the pass and weir, but later on, in 1869, foot-bridges were constructed for the weirs.

The ordinary tripping-bar of the Chanoine wicket-dam can only be operated for a certain length of pass. By using two of these bars, one operated from each side of the pass, this length can be doubled. While having the advantage of lowering a dam very rapidly when all goes well, any obstruction that might get in the channel of the tripping-bar or in front of a hurter would prevent the lowering of the dam. For this reason M. Pasqueau, in constructing a movable dam across the Saône near Lyons (page 331), decided to dispense with the tripping-bar and to arrange the wickets so that each could be lowered separately. He accomplished this by devising a special double-grooved hurter and slide (Fig. 97), in which a step *b* is placed in front of the step *a* on which the prop rests. When a wicket is to be lowered it is first put on the swing. The breech-chain is then pulled.



This drags the prop from its rest and lets its foot fall to the lower step *b*. As the face of this step is inclined so as to offer no support, the prop slides down a passage in the hurter and down "the slide" behind the hurter until the wicket has been lowered.

Chanoine wickets, having their axis of rotation placed at  $\frac{1}{3}$  to  $\frac{1}{2}$  their height, at the centre of pressure of the water, open freely when the water rises above their crest, but do not close rapidly enough when the level of the upper pool falls, and cause thus a loss of water. This trouble has been removed and the raising of the

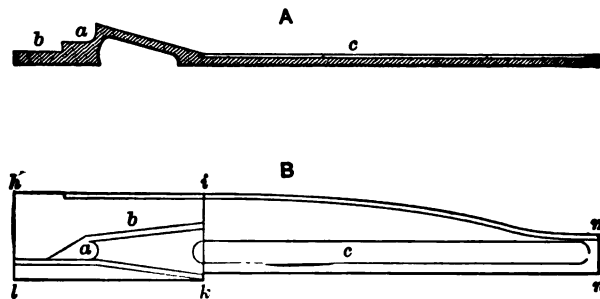


FIG. 97.—PASQUEAU HURTER.

shutters facilitated by placing one or two butterfly (flutter) valves near the top of the shutter (page 335). These valves (which are diminutive shutters about 3 feet high by 2 feet wide, revolving on horizontal axes) open when the shutter is being raised, and thus diminish the resistance. They regulate the level of the upper pool by opening and closing in a much more rapid manner for small variations than can be done by allowing the whole shutter to oscillate.

M. Chanoine's system has been largely used for movable dams on the upper Seine, Loire, Saône and Meuse. While it is more complicated and expensive than the systems of frame-dams which we have described, it has the advantage of permitting a much more rapid opening of the dam. When used with a maneuvering-boat this system is applicable to rivers carrying much drift, where any system of frame-dam would fail. It is for this reason that Chanoine shutters were used in the movable dams constructed on the Kanawha and Ohio rivers in the United States.

**La Mulatière Dam**, near Lyons, was constructed in 1879-81 across the Saône River at its junction with the Rhone. As the latter is a torrential stream subject to rapid rises and falls and often forces back-water into the mouth of the Saône, the dam was in the peculiar position of being exposed to sudden rises as well from below as from above. A sudden fall in the Rhone necessitated the rapid erection of the dam to maintain the required depth in the Saône. The dam had, therefore, to be constructed so that it could be rapidly raised or lowered.

To meet these conditions M. Pasqueau, the engineer in charge of the work, introduced various modifications in the system of Chanoine wickets, which was used, by inventing new details for the construction and devising new methods of maneuvering.

As a great deal of gravel was carried by the stream, M. Pasqueau dispensed with the tripping-bar, which might have easily been obstructed, and arranged the wickets to be raised or lowered from a maneuvering-bridge. This was made possible by using a double-stepped hurter or resting-shoe for the props, described on

page 331. The ordinary tripping-bar cannot be used for passes much over 150 feet wide. With Pasqueau hurters the width of the pass need not be considered. In the Mulatière dam it is 340 feet wide, no piers being placed in the stream.

Iron wickets are used in this dam, as those of wood only last for ten years. The panels are formed of two "U" irons, 2.95 feet apart, covered by  $\frac{3}{8}$ -inch plate iron, projecting 10 inches beyond the uprights, supported by braces, and having angle irons put on the edges. They are 14.3 feet long and 4.6 feet wide. A flutter-valve, 5 feet by 3 feet, is put into the upper half of each wicket. It is held in place by a bell-crank and is operated from the bridge by means of a pole.

The dam is maneuvered from a Poirée service-bridge by means of a steam windlass. The frames, which are 22.3 feet high, are placed 9.8 feet apart—more than twice the usual distance. As a frame when down laps only over two other frames, the bedding trench is only 28 inches deep instead of the four feet usually required. The frames are symmetrically built in the form of a double St. Andrew's cross, possessing great stiffness. They are said not to silt up as much as those having vertical up-stream posts. Instead of the old style axles, they have at the bottom pin connections with the journal boxes in the floor.

The Dams on the Great Kanawha River\* are of the Chanoine-wicket type, and are operated from frame service-bridges. They are the first movable dams erected in the United States for slack-water navigation. The first two of these dams were completed in 1880, and others have since been erected with improvements in the details of construction. As their general features are very similar it will suffice to describe one of these dams.

Dam No. 7 (Fig. 98), which was completed in 1892, is located about forty-four miles above the mouth of the river. It has a pass 248 feet wide, a weir 316 feet wide, and a lock 342 feet long between quoins, with a width of 55 feet in the clear. A masonry pier 10 feet wide and 34.6 feet long separates the pass and weir. The dam terminates at one bank at the lock-wall and at the other at a masonry abutment.

The foundation of the pass is 50 feet wide. It was prepared by laying a bed of concrete on solid rock or hard-pan. The timbers to which the wickets are bolted are placed on this concrete. The wooden sill against which the wickets bear, when up, was laid 2 feet below low water. The edges of the foundation are coped with large bush-hammered stones secured by bolts.

The pass is closed by sixty-two Chanoine wickets having Pasqueau hurters. The wickets are of oak with pine panels and are banded with iron. They are placed 4 feet apart, and are 3 feet 9 inches wide and 14 feet  $\frac{1}{8}$  inch long. The 3-inch space between the wickets can be closed with scantling when required. The axis of rotation is placed 6 feet 10 inches from the bottom of the wicket and 5 feet 11 inches vertically above the top of the sill. When up, the wickets form an angle of  $20^{\circ}$ , with a vertical plane and lap five inches on the sill.

---

\*The account given of these dams is condensed from a description written in 1892 by Mr. Addison Scott, the Resident Engineer in charge of the work. This description was published by the Government, and is given also in W. M. Patton's Treatise on Civil Engineering, pp. 1494-1507.

The service-bridge of the pass is formed by thirty wrought-iron frames, each having a section of the floor and connecting-rods for joining it to the next frame attached. The frames are 8 feet apart between centres, and are connected by the chain used in raising them. When erected the bridge floor is  $2\frac{1}{2}$  feet above the top of the wicket, which is the normal pool level.

The weir is closed by seventy-nine wickets set 4 feet apart, each being 3 feet 9 inches wide and 9 feet  $2\frac{1}{2}$  inches long. The axis of rotation is placed 4 feet from the bottom of the wicket and 3 feet  $4\frac{1}{4}$  inches vertically above the top of the sill. The wickets make the same angle with the vertical as those of the pass, and lap 4 inches

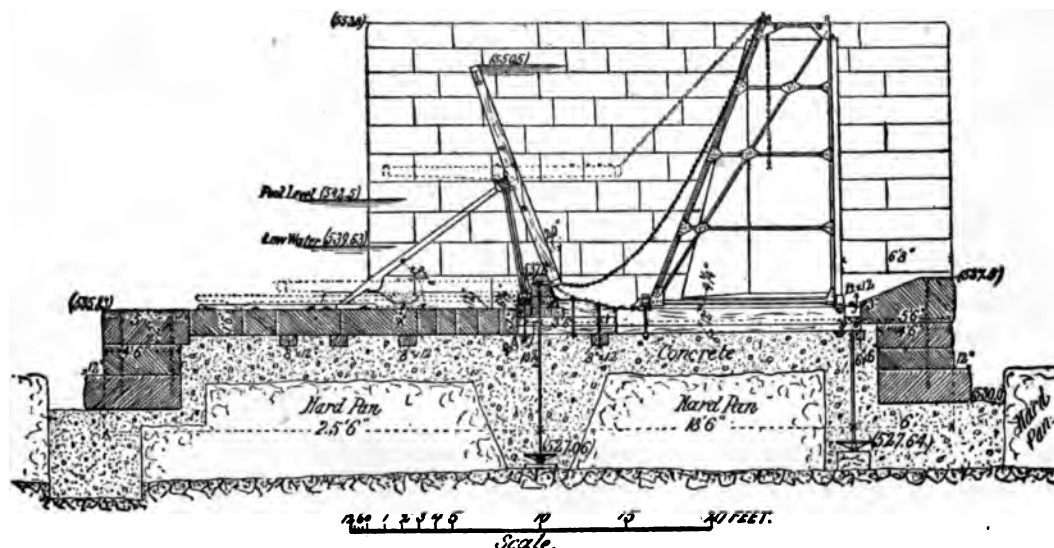


FIG. 98.—SECTION OF THE NAVIGATION PASS OF THE KANAWHA DAM.

on the sill when up. The service-bridge of the weir is similar to that of the pass. The wicket sill is of cast-iron. It is made in sections and has the horse-boxes attached.

The dams are maneuvered in the usual manner from the service-bridges. A light service-boat, having a derrick and capstan, is kept at each of the dams to assist in the maneuvers. The different dams and the central office in Charleston are connected by telephone so that due notice can be received of any rise in the river, etc.

Each of the dams can be erected by four or five men in seven to twelve hours, eight hours being usually required. This force can lower the dam in about two hours. Four men are constantly employed at each dam, one or two extra men being engaged when needed. The cost of operating and maintaining one of the dams amounts to about \$2500 a year. A certain number of buildings, such as a storehouse, a blacksmith-shop, a carpenter-shop, etc., are built for each dam.

**Ohio River Dams.\***—The Chanoine Dam at Davis Island, five and one-half miles below Pittsburg, is the first of a series of movable dams which are to be constructed to improve navigation on the Ohio River. The work on this dam was

\*Engineering News, May 15 1886, and Scientific American Supplement, August 1. 1891.

begun in 1878 and finished in 1885. A channel 456 feet wide, between the island and the south bank of the river, was closed by a permanent dam. A movable dam was constructed across the main channel of the river. This dam consisted originally of a navigation pass 559 feet wide, and of three weirs, respectively, 224, 224, and 216 feet wide. Later on, the first weir was shortened by the construction of a drift-gap 52 feet wide, closed by a bear-trap gate (page 345), and the pier between this weir and the pass was removed, widening the latter to 716 feet. A lock, 600 feet long between gates and 110 feet wide, was built on the north side of the movable dam. It is the largest and widest lock thus far constructed. The gates of this lock, instead of swinging in the usual manner, are rolled into recesses or slips built for them in the bank for a distance of 120 feet.

The movable dam between the lock-wall and the abutment at Davis Island has a length of 1223 feet. It is formed by 305 wickets, which are placed 4 feet apart, between centres. The wickets are made of oak. They are 3 feet 9 inches wide. Their length varies from 12 feet 11 inches in the pass to 9 feet 9 inches in the weir nearest the island. When erected the wickets are inclined down-stream so as to make an angle of  $20^\circ$  with a vertical plane. The 3-inch space between any two adjoining wickets can be closed by scantling when required.

The apron of the dam, upon which the wickets are placed, is a framed structure composed principally of  $12'' \times 12''$  white-oak timbers, which are embedded in concrete. The wickets are anchored to this structure by long bolts. Cast-iron journal-boxes for the axles of the horses and Pasqueau hurters for the props are also bolted to the apron-timbers.

The wickets of the pass are maneuvered from a steel boat, having a winch at its centre. A pole is attached to the end of the rope from the winch. This pole is provided with a hook and serves for grappling the wickets when they are down. In lowering the dam, each wicket is caught on top and pulled up-stream until the props drops to the lower step of the hurter, and moves down the slide, taking the horse and shutter with it.

The wickets of the weirs are maneuvered from a Poirée service-bridge having frames 15 feet  $1\frac{1}{2}$  inches high, placed 8 feet apart.

A second Chanoine wicket-dam, like the one described above, was built across the Ohio River, about 31 miles below Pittsburg, Pa. (see page 364).

The Pontoon-dam invented by M. Krantz was to consist of a number of revolving shutters, each being moved by a pontoon which could be made to float or sink in a conduit constructed on the down-stream side of the dam. The pontoon was to be connected to the shutter by a hinge. It was to be fastened to the down-stream side of the conduit in which it was placed by another hinge, so that both the pontoon and shutter would revolve on horizontal axes.

M. Krantz gave, in 1868, a description of a design he had prepared for such a dam which was to retain 10 feet of water (Figs. 99 and 100)\*. The shutters were to be 9.83 feet wide, 16.33 feet high, and to incline  $30^\circ$  from a vertical plane when up. They

---

\*This description is given in full in Lagrené's *Cours de Navigation Intérieure*, Vol. VIII., p. 332.

were to abut against a sill and to have their axis of rotation 1.33 feet above the centre of pressure. Three flutter-valves (butterfly valves) (Fig. 101), 3.12 feet high and 2.04 feet

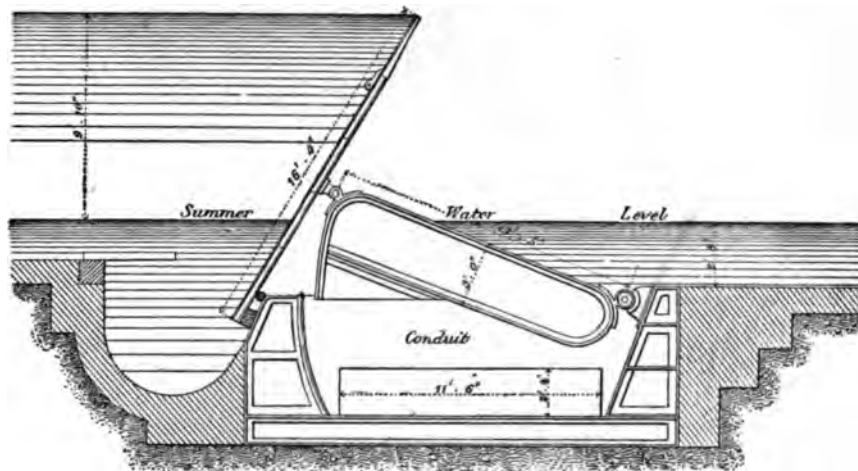


FIG. 99.—KRANTZ PONTOON-DAM.

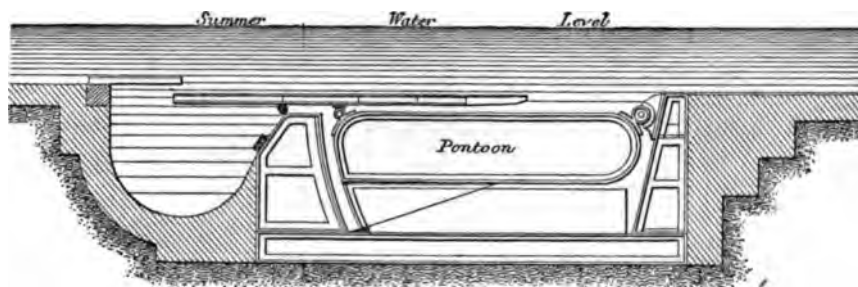


FIG. 100.—KRANTZ PONTOON-DAM.

wide, turning on horizontal axles, were to be placed near the top of each shutter to regulate the level of the upper pool when the dam was up. These valves were to work automatically. When the water in the upper pool should reach a certain level the valves were to open, but their motion was to be limited by stay-chains attached to the shutter so that the valves would not be at a greater inclination than  $15^{\circ}$  from the horizontal when open. If the level in the pool should fall, counter-weights fastened to the valves by chains were to close them.

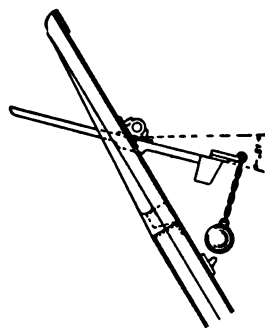


FIG. 101.—BUTTERFLY VALVE.

The pontoons were to be made of sheet iron. They were to have a rectangular cross-section and to be hollow. The manner in which they were to be hinged both to the conduit in which they were to be placed and to the shutters is shown in Fig. 99.

The conduit was to be made of cast-iron frames, which were to be surrounded by masonry. A small reservoir or lock, made of iron, was to be constructed at each end of the conduit. It was to be arranged in such a manner that it could be connected

by opening suitable valves either with the upper or lower pool. As these reservoirs were to be connected by openings with the conduit, the level of the water in the conduit could be varied by means of the valves of the reservoirs. By opening the up stream and closing the down-stream valve the water from the upper pool would be admitted into the conduit and the pontoons would float and raise the dam. If the position of the valves were reversed, the water from the conduit would flow to the lower pool, and the pontoons would consequently sink and open the dam. By partly opening both the up-stream and down-stream valves the dam could be made to assume some intermediate position between the two extremes shown in Figs. 99 and 100. It was calculated that each pontoon in rising would have a sufficient force to raise a shutter.

The dam at Port Villez (page 319) was to be constructed according to the system of M. Krantz, but experiments conducted on a large scale at the site of a proposed lock at Bougival showed that a sufficient amount of water to raise a pontoon dam could not be drawn from the upper pool without lowering its level too much. This system was abandoned in favor of one invented by M. Caméré.

The Girard Shutter-dam (Fig. 102) was invented in 1869 by M. Girard, a prominent French engineer. It is a modification of the Thénard system consisting in raising

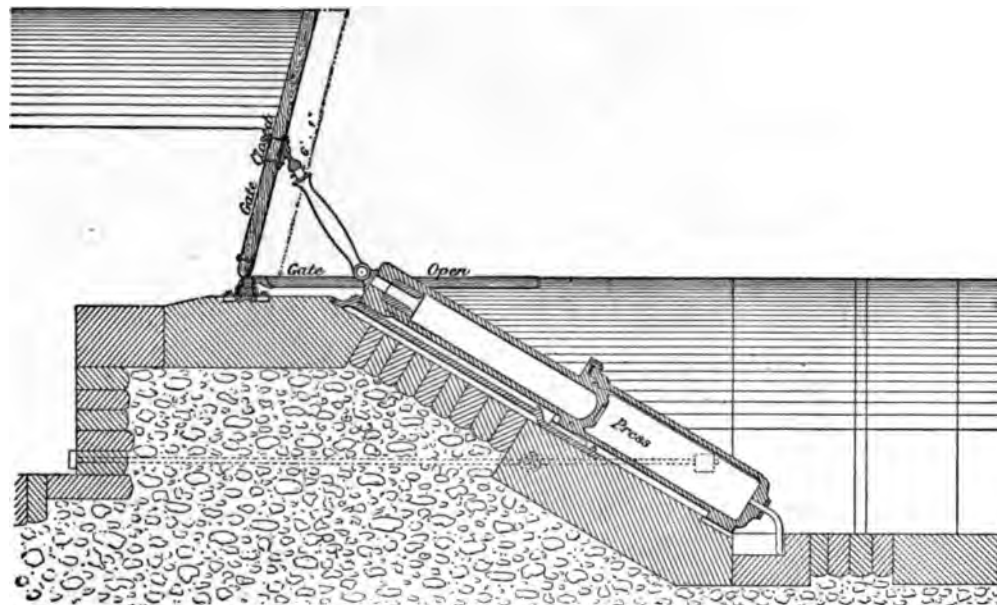


FIG. 102.—GIRARD SHUTTER-DAM.

the shutters by the pressure obtained by means of hydraulic jacks placed on the apron of the dam.

**Ile Brûlée Dam.\***—M. Girard obtained a contract to erect seven shutters according to his system on the weir of the Ile Brûlée dam at Auxerre on the Yonne, the pass of which is closed by Chanoine wickets. He was killed in the Franco-Prussian war before he could finish the work. It was successfully completed by M. Callon. The shutters

\* *Annales des Ponts et Chaussées* for 1873, 5th Series, Vol. VI, page 360.

on this weir are 11.55 feet wide by 6.46 feet high. Each shutter is formed of three pieces of "I" beams, which are covered on the up-stream side by fir joists 4 inches thick and on the down-stream side by sheet iron. The "I" beams are connected at the bottom to the axle on which the shutter turns. This axle is placed in a cast-iron hollow quoin, which is embedded in the masonry on the crest of the dam. Each shutter weighs 2552 pounds. A space of  $1\frac{3}{4}$  inches is left between consecutive shutters.

Each shutter has a separate hydraulic jack, which is fastened to the down-stream side of the masonry apron at an inclination of  $30^\circ$ . The jacks are made of cast iron. They have an exterior diameter of 16 inches and walls  $1\frac{1}{2}$  inches thick. The piston is made of cast iron and is covered with a jacket of red copper. It moves a cast-iron cross-head four feet long, which is connected to the shutter by three rods attached to an axle placed on the shutter at about half its height.

A turbine water-wheel, 4 feet in diameter, operated by the head of water above the weir, furnishes the power for the hydraulic jacks. It is placed in an engine-house built on the abutment of the dam, and works both a water-pump and an air-pump. The water may be pumped directly to the jacks, but ordinarily it is pumped into a receiver in the engine-house, called an accumulator, having an inner diameter of 26 inches and a height of  $11\frac{1}{2}$  feet. The accumulator is made of cast-iron and has walls 2 inches thick. It is connected with each jack by a copper pipe one inch in diameter. A three-way cock placed in the engine-house on each of these lines of pipe controls the communication between the pump, accumulator, and jack.

The accumulator acts as an air-chamber for the pumps, and stores sufficient power for raising the shutters when the upper pool is too low to turn the turbine-wheel. When it is empty, and the weir and pass are both open, the turbine-wheel is started by raising the Chanoine wickets in the pass by means of a maneuvering-boat.

As a rule, the Girard shutters are worked from the accumulator, and not directly from the pump. When the accumulator is empty, air is forced into it from the air-pump until a pressure of about 10 atmospheres has been obtained. Water is then pumped into the accumulator until the pressure has been raised to 20 to 25 atmospheres.

Each shutter is operated independently of the others, by means of the three-way cock in the engine-house, mentioned above. One shutter may be up, another down, and the others in any intermediate positions. When there is but little water in the weir, the shutters can be raised together from the accumulator in less than thirty seconds, but when the fall over the weir is 3 feet or more, the pump must be kept at work to assist the accumulator. In the latter case, the seven shutters can be raised in ten to fifteen minutes. It requires about two minutes to lower a shutter. This operation must not be performed too rapidly, in order to avoid scour. The maneuvering is facilitated by placing "butterfly-valves" in the shutters, which open when the shutter is down, so as only to present their thin edge to the pressure of the water.

When M. Girard first proposed his system, the objections were raised that his plan involved complicated machinery; that the jacks might become filled with sand;

that the water in the jacks or in their feed-pipes might freeze, etc. The trial of this system in the Ile Brulée dam has, however, been very successful. Freezing has been prevented by placing the jacks below water. During a severe winter, when the temperature fell to 13° Fahrenheit below zero, the only damage done was to some pipes in the engine-house, which had not been properly protected.

Owing to the size of the shutters and their being placed very closely together, the leakage through this dam is much less than what is usual with other systems of movable dams.

**Desfontaines Drum-dam.**—In 1846, M. Desfontaines invented and experimented with a new system of movable wickets which was introduced for the first time in the dam of Damery on the Marne and in 1861 on the Courcelles Dam. From 1861 to 1867 this form of wicket was placed on the overfall-weirs of nine of the dams on the Marne.

The arrangement of this invention is shown in Fig. 103. The dam is composed of sections about 5 feet long, which are placed on top of a masonry weir. Each of these

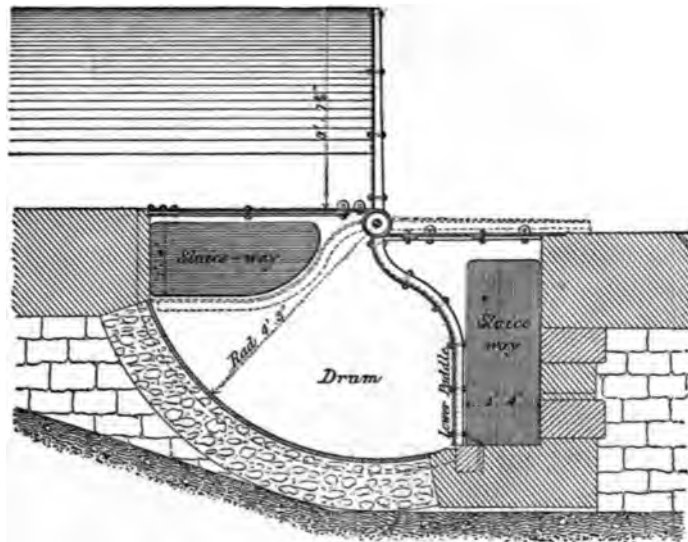


FIG. 103.—DESFONTAINES DRUM-DAM.

sections revolves on a horizontal axle placed at its centre. Its upper part, which acts like a shutter, is called the wicket proper; the lower portion, which serves to raise or lower the wicket, is called the counter-wicket. For convenience it is somewhat curved. The counter-wicket is placed in a chamber on top of the weir, which forms a quarter of a horizontal cylinder. In the first dams built according to this system the chamber was simply formed of sheet iron, but it was afterwards found advisable to surround it with masonry. The chamber was called "a drum," and from this the new device was called a drum-dam.

The counter-wicket is moved by admitting the water from the upper pool on its up-stream or down-stream side. In the former case it raises the dam; in the latter it lowers it. At the same time when the water from the upper pool is admitted to one side of the counter-wicket a connection is made on the other side with the lower pool, as explained hereafter.

The different sections composing the dam are placed side by side, so that their axles



shall be in the same horizontal line. They are separated in the drum by cast-iron diaphragms having on both sides projecting ribs corresponding to the extreme positions of the counter-wicket, and two openings or sluiceways placed as shown in Fig. 103. When the water from the upper pool is admitted at the end of the drum to the up-stream sluiceway

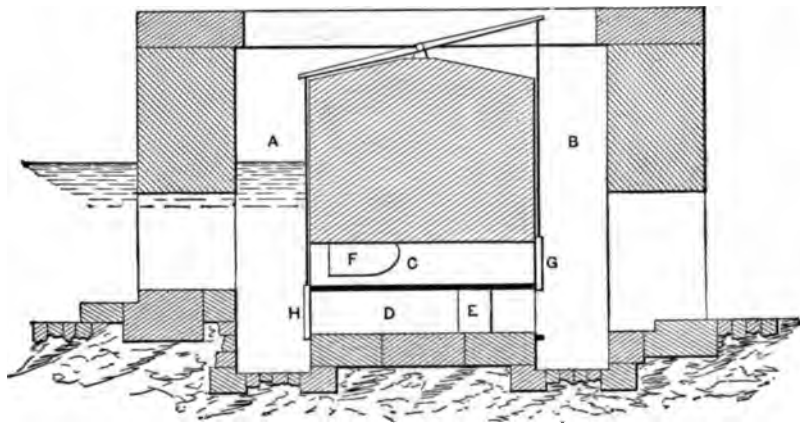


FIG. 104.—ABUTMENT OF DESFONTAINES DRUM-DAM.

of the first diaphragm, it presses the first counter-wicket down until it bears against a sill at the bottom and then flows from chamber to chamber, turning all the counter-wickets in succession, thus raising the dam. While this occurs, the sluiceways on the down-stream side of the counter-wickets are connected with the lower pool to avoid any counter-pressure by leakage between the different sections of the dam. In order to reduce this leakage as possible strips of rubber are attached to the bottom and sides of each counter-wicket to make tight joints where it bears against the sill and the projecting ribs of the diaphragms mentioned above.

The flow to and from either side of the counter-wickets is controlled at a pier or abutment built at the end of the dam, as shown in Fig. 104. Two wells are constructed in the pier or abutment, one, *A*, being connected with the upper pool and the other, *B*, with the lower. A rectangular gallery connects the two wells. It is divided by a horizontal metal plate into an upper and lower passage, *C* and *D*. The former is connected by a suitable channel *F* with the up-stream side of the counter-wickets and the latter is connected by another channel *E* with their down-stream side. A sluice-gate of such size that it covers the upper or lower passage between the wells is placed at each end of the gallery connecting the wells. These two sluice-gates, *H* and *G*, are attached to a balance-beam in such a manner that when one gate covers the lower passage the other gate closes the upper one. By this simple arrangement all the wickets can be raised or lowered. In ordinary cases the lowering of the whole drum-dam would reduce the level of the upper pool too much. To avoid this difficulty the wickets of the early Desfontaines dams were provided with props somewhat like those of the Chanoine shutters. By suitable contrivances these props could be stopped at certain points when the dam was being lowered, or permitted to slide down completely. In this manner the distance to which the crest of the drum-weir was lowered could be regulated. It was found out, later on, that these props were not needed when the motion of the wickets was controlled

in the pier or abutment in the manner shown in Fig. 104. By setting the gates *H* and *G* so as to cover only partly the passages *D* and *C* a counter-pressure is produced which prevents the whole dam from being lowered. The wickets at the pier are lowered and those more remote remain up. By varying the position of the gates the number of wickets that are lowered can be controlled.

The largest Desfontaines Dam was constructed in France in 1867, across the overflow-weir of a dam on the Marne at Joinville. It consists of forty-two wickets, each being  $3\frac{1}{2}$  feet high and  $4\frac{3}{8}$  feet wide. This weir can be opened or closed by one man in three or four minutes. Larger drum-dams of this kind were constructed in 1883-86 across the timber-passes of four weirs on the Main, in Germany.\* In this case each of the passes, which was  $39\frac{1}{8}$  feet wide, was closed by a single wicket, retaining a head of 5.58 feet above the sill of the dam. Another large drum-dam has been placed across the navigable pass of the Charlottenburg Dam, on the river Spree.\* It is formed of one wicket  $32\frac{1}{2}$  feet wide, which retains  $9\frac{1}{2}$  feet of water, the difference in level between the upper and lower pool being ordinarily 4 feet.

The drum-dam is undoubtedly the most perfect type of movable dam, as it gives perfect control over the wickets, and enables them to be raised even against a rapid current; but it is also the most expensive type, and its use is practically limited to overflow weirs, on account of the difficulty of constructing and maintaining the drum in a deep channel. The cost of the drum-dam at Joinville was about \$135 per lineal foot. In the Charlottenburg navigable pass, the cost of the drum-dam reached \$725 per lineal foot.

**Cuvinot Drum-dam.**—An improvement on Desfontaines' Drum-dam has been invented by M. Cuvinot.† The objects aimed at in the new design are:

- 1st. To make the wickets independent of each other.
- 2d. To arrange them so as to be stable in any position.
- 3d. To reduce the depth of the counter-wickets, and, consequently, the size of the drum.
- 4th. To diminish the leakage through the drum.

Fig. 105 shows the manner in which M. Cuvinot proposed to accomplish these objects. A semi-cylindrical and two rectangular conduits are constructed on top of the masonry weir for its whole length. The first-mentioned conduit forms the drum in which the counter-wickets are placed; the other two are the inlet and outlet conduits, the former being placed on the up-stream side of the drum and connected with the upper pool, while the latter is built on the down-stream side and connected to the lower pool. The drum is divided into compartments, corresponding to the length of the wicket, by tight diaphragms, which support the axles of the wickets and counter-wickets. Each of these compartments is connected with the inlet-conduit by a hole that always remains open. Another opening, which can be controlled by a valve, connects it with the outlet-conduit. The counter-wicket has a short arm projecting out of the drum and provided at its extremity with a friction-roller, which bears against the down-stream side of the

\* Rivers and Canals, by L. F. Vernon-Harcourt, M.A., Vol. I., p. 143.

† Cours de Navigation Intérieure, by H. Lagrené, Vol. III., p. 319.

wicket. The water from the upper pool fills every compartment of the dam, as the counter-wickets do not make tight joints at their bottom and sides. If the outlet-valve of any compartment be closed, the water in the compartment remains in equilibrium, and the pressure of the upper pool against the wicket turns the dam down. If the valve be opened, the pressure on the down-stream side of the counter wicket is at once reduced, and the counter-wicket revolves and raises the wicket by

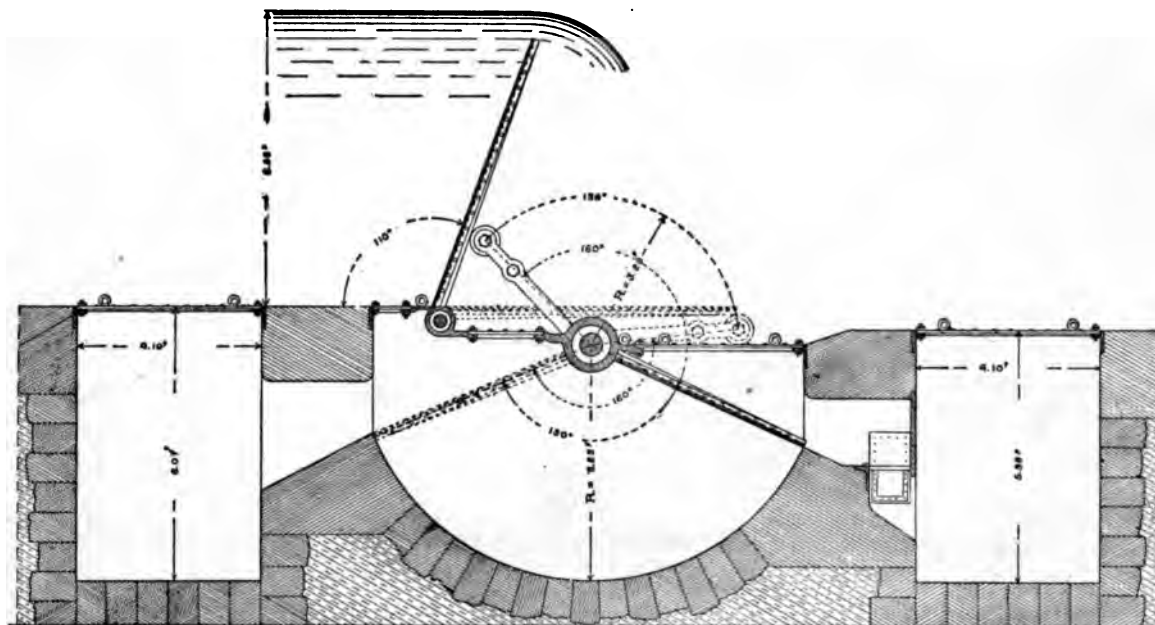


FIG. 105.—CUVINOT DRUM-DAM.

means of its projecting arm. The extent to which the valve is opened determines the difference in pressure against the two faces of the counter-wicket and regulates the height to which the wicket is raised. By arranging the outlet valves of the different compartments so as to be worked from either end of the weir, the dam-tender can control the position of every wicket. Fig. 105 shows the two extreme positions which the wickets and counter-wickets can assume.

**Chittenden Drum-dam.**—An improved type of drum-dam, invented by Capt. H. M. Chittenden, Corps of Engineers, U. S. A., was used in the improvement of the Osage River, in a dam having a maximum difference of 16 feet between the upper and lower pools.\* Fig. 106 shows the manner in which this dam was to be constructed. It rests entirely on a pile foundation, which is covered by a water-tight floor of 4-inch plank, except at the apron. The second row of piles from the up-stream face consists of a triple thickness of sheet-piling. A block of concrete *HJK* forms the fixed part of the dam. The movable part consist of a box-gate having the sector of  $67\frac{1}{2}^\circ$  of a circle as its cross-section and revolving around the axle *A*. The interior framework of the gate is made of iron, but the outside consists of wood. The ends of the gate

\* Paper on "Modified Drum-weir," by H. M. Chittenden, in *Journal of the Association of Engineering Societies*, June, 1896.

(or of different sections forming it) are closed and made air-tight from *C* down for about one-third the height. The upper face, *AB*, and the cylindrical face for about two-thirds the distance from *C* to *B*, are also made air-tight. The lower face is water-tight. When down the gate falls into the chamber *AZQ* and rests against the step *Z*. This chamber is constructed in the following manner. Iron frames *DEFG*, which support the axle of the gate and are anchored into the concrete, are placed 5 feet apart. On the opposite side of the chamber iron frames *LMNOPD* are put

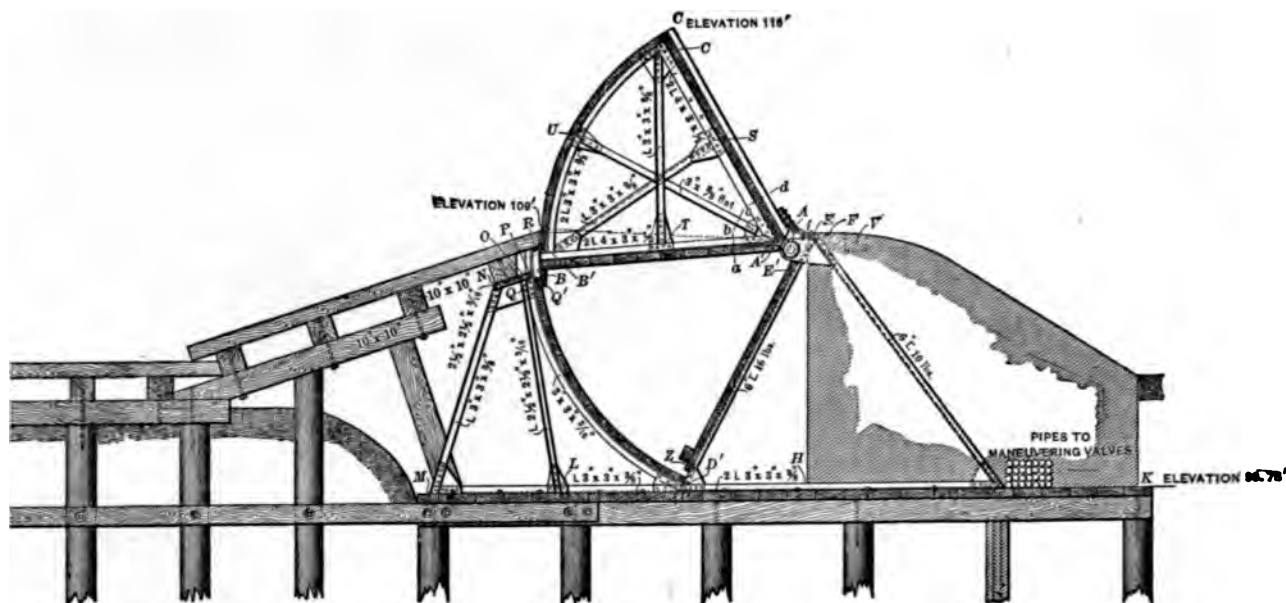


FIG. 106.—CHITTENDEN DRUM-DAM.

up every  $2\frac{1}{2}$  feet. Water-tight wooden partitions *D'Q* and *E'Z*, supported by the iron frames, form the two sides of the chamber, which has a cross-section corresponding to that of the gate. The frames, *LMNOPD*, carry also the upper part of the timber apron.

The triangular space *DEH* forms a longitudinal culvert for conveying water to or from the chamber *AZQ*. The inlet to the chamber consists of a narrow opening at *Z* extending the whole length of the gate so as to admit the water uniformly under the face *AB* of the gate and having an area slightly in excess of that of *DEH*. The flow into the culvert *DEH* and thus into the chamber *AZQ* is regulated by suitable gates placed in the piers which separate the different sections of which this drum-gate is composed. When the water from the upper pool is let into the chamber *AZQ* there is generally enough head to raise the gate to its normal position when up. Should there not be sufficient head to raise the gate, its buoyancy is increased by admitting air into the gate from an air-pump on shore and expelling some of the water until it rises to its normal position. As the gate rises to its normal position it can be stopped by means of the inlet-valve or automatically by letting the water escape at openings at *Q*. Seven of these openings, having together an area of 10 square feet, are provided for each section of the drum. The inlet

culvert has an opening of 12 square feet, but as there is always some leakage, the openings at  $Q$ , when entirely uncovered by the drum, can discharge all the water conveyed by the inlet-culvert. The drum remains, therefore, stationary when it has reached its highest position.

In devising this gate Captain Chittenden's object was to overcome the defects inherent in the bear-trap gate (page 345). Compared with the latter, the Chittenden gate has the following advantages:

- 1st. It has but one axis of motion.
- 2d. It has no angles in which drift can lodge.
- 3d. It can easily be built in sections.
- 4th. It contains no sliding surfaces causing friction.

## CHAPTER III.

## DAMS WITH BEAR-TRAP GATES.

**History of the Gate.\***—In 1818, Josiah White, a Philadelphia merchant, and Erskine Hazard, the managers of the Lehigh Navigation Company, commenced the improvement of the Lehigh River, to obtain slack-water navigation for transporting anthracite coal to market. At first the improvement consisted only in the construction of wing-dams, but this did not furnish the minimum water-way required by the charter of the company, viz., a width of 25 feet with a depth of 18 inches. White and Hazard had, therefore, to seek other means of increasing the depth of the water. They determined to accomplish this by producing artificial freshets by means of some kind of movable gate which was to be placed across the river. White spent several weeks in trying to construct a satisfactory device for this purpose, and finally produced the well-known bear-trap gate. He built a small gate of this character in the Mauch Chunk Creek, which excited much attention during its construction. The workmen employed tried to rid themselves of curious people, who wished to find out what Mr. White was constructing, by telling them that it was a "bear-trap," a name the gate has borne ever since. In 1819 twelve dams having gates of this kind were placed in the Lehigh River, and proved to be perfectly successful. Later on this gate was used on the logging streams of Pennsylvania and Canada.

Some bear-trap gates were built also in France, and have remained in use in smaller streams. A larger gate of this kind, constructed for the river Marne (Fig. 65), not properly proportioned, was a failure. As the results were widely published without the causes of the failure being carefully examined, a prejudice against this style of gate became deeply rooted among engineers for many years. The gate fell almost into disuse, excepting on logging streams in Pennsylvania, where it has remained in use to the present time.

One of the first engineers to revive the interest in the bear-trap gate was the late Ashbel Welsh, President of the American Society of Civil Engineers, who, in his annual address delivered to that Society in 1882, stated:

"The bear-trap locks (White's on the Lehigh) have given the hint for several devices since used, and are well worthy of an examination.

"It is well worth inquiry whether these bear-trap gates would not be the best possible, and possibly the cheapest, for letting the water rapidly out of a reservoir for scouring purposes. A full stream could be set running in a few seconds, and the flow could be regulated with perfect ease and stopped at any moment."

---

\* Paper on "Movable Dams, Sluice- and Lock-gates of the Bear-trap Type," by Archibald O. Powell, read before the Civil Engineers' Society of St. Paul, and published in the *Journal of the Engineering Societies* for June, 1896.

Soon afterwards, in 1883-84, a board of United States Engineer officers recommended the adoption of two bear-trap gates in the passes of the Beattyville Dam on the Kentucky River. These gates, each of which is 60 feet long, were built in 1886. They proved to be satisfactory, although they might have been better proportioned. In 1888 a bear-trap gate 52 feet wide was placed in the drift-pass of the Davis Island Dam on the Ohio River (Fig. 107).\* The construction of this gate caused the United States Engineers to make a theoretical study of the bear-trap gate. This work was assigned, in 1892, to Captain Chittenden, U. S. A., and Mr. Archibald O. Powell, United States Assistant Engineer.†

**Description of the Gate.**—As originally constructed the gate consists of two rectangular leaves of a length equal to the width of the opening in which they are placed (Fig. 107). Each of the leaves has at the bottom an axle or hinges which enables it to revolve. When the gate is down the up-stream leaf overlaps the down-stream leaf. The gate is raised by the pressure of the water from the upper pool, which is conveyed in a channel controlled

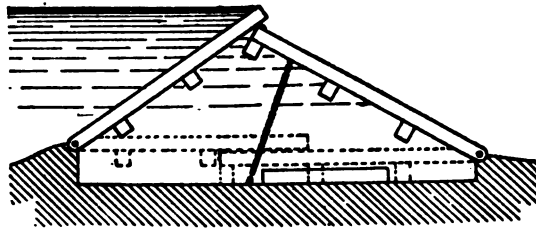


FIG. 107.—BEAR-TRAP GATE, DAVIS ISLAND DAM.

by a sluice-gate to a chamber constructed under the gate. A second channel, also provided with a gate or stop-cock, connects this chamber with the lower pool. When the connection with the upper pool is opened while that with the lower pool is closed, water from the upper pool fills the chamber under the gate. This causes the down-stream leaf to rise, first by flotation and then by the impulse from the flow of the water. In rising, the lower leaf raises the upper leaf by its edge sliding under it, the friction being reduced by rollers. The height to which the gate rises is limited either by stay-chains attached to the lower leaf or by a piece of wood nailed on the under side of the upper leaf. In lowering the gates, the operation is reversed, the connection with the upper pool being closed while that with the lower pool is opened. By regulating the extent to which the two valves controlling the inlet and outlet of the chamber under the gate are opened the gate may be made to assume any intermediate position between the two extremes mentioned above.

Although very simple in principle, the old "bear-trap gate" contains a number of objectionable features. The overlap of the upper over the lower leaf necessitates lifting a considerable amount of water when the gate is to be raised. The head obtained is only about one-third of the total length of the gate. The friction between the two leaves, even when

\* FIGS. 107 to 111 (except 108) are taken from the paper of Mr. Powell mentioned on page 344.

† The results of these investigations were given by these engineers in papers read before the Civil Engineers' Society of St. Paul, which, with several others on "American Hydraulic Gates, Weirs, and Movable Dams," written by other engineers, have been published in the Journal of the Association of Engineering Societies for June, 1896.

reduced by rollers, makes it difficult to operate the gate smoothly. As the gate is not adapted to being made in sections, its width has to be equal to the opening which it is to close. With a wide gate, however, one side is apt to go up faster than the other, causing twisting strains in the leaves.\* The sudden stopping of the gate when it has reached its proper height causes great strains and is apt to damage the gate. Any driftwood or stone that may lodge between the leaves makes the lowering of the gate impossible. These defects have fortunately been overcome by recent improvements and modifications in the construction of this style of gate, and it seems now very probable that the bear-trap gate in some improved form will be used largely in the construction of movable dams and also for locks.

The three principal problems to be solved in connection with bear-trap dams are:

- 1st. To secure the power to start the gates when they are to be raised.
- 2d. To prevent warping and twisting during the raising and lowering.
- 3d. To construct the gate so that it can be used for passes of considerable width without having intermediate piers.

Some initial head is always required to start the gate when it is to be raised. Mechanical means for starting the raising were used in some of the early gates. In the Neuville Dam on the Marne, in France (Fig. 103), which has a sluice closed by bear-trap

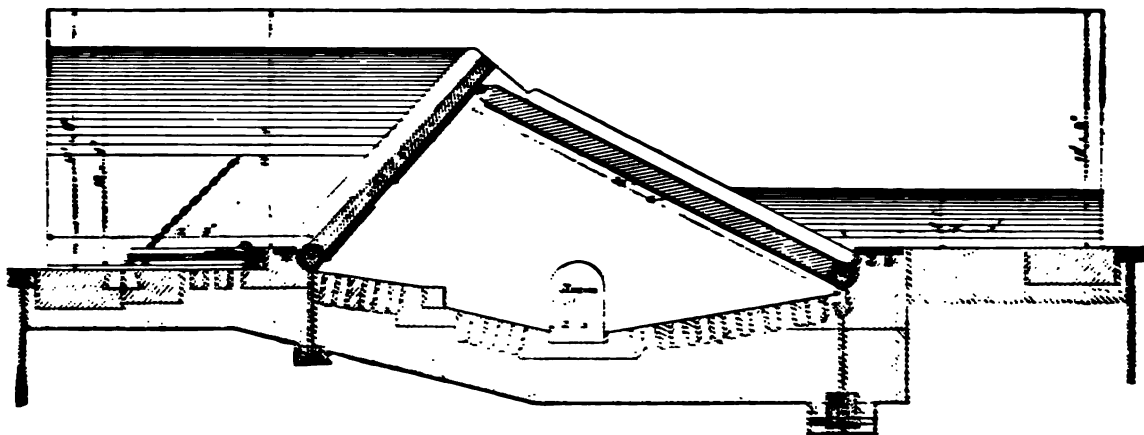


FIG. 103.—BEAR-TRAP DAM ON THE MARNE.

gates, the initial head for starting them is obtained by means of an auxiliary dam consisting of Thiéard counter-shutters. An experiment is to be made to start the bear-trap gates of Dam No. 6 on the Ohio River by compressed air, but this involves an expensive plant.

The most favorable conditions exist when the required head for starting the gates can be obtained from some auxiliary reservoir. When this is impracticable or too costly, the "head" will generally have to be obtained by some auxiliary dam, as at Neuville, although some cheaper construction may be devised.

\* In a bear-trap gate 120 feet long and about 3 feet high, built in Dam No. 1, of the Monongahela River, the warpage was so great in raising the gate that the end next to the filling culvert came up 5 feet in advance of the opposite end. In lowering, the end at the culvert was also about 5 feet in advance of the other end, so that the variation in the crest amounted to 10 feet. (Journal of the Association of Engineering Societies for June, 1896, p. 209.)



Uniformity in the movement of the gate can be insured, where the width of the pass is not too great, by admitting or drawing off the water at both ends. If the gate is made as tight as possible the water can be admitted slowly, which insures uniformity of motion. Long gates should be constructed in such a manner that the water can be admitted uniformly under the gate not only at the ends, but at some intermediate points.

Mr. Dubois tried, but without success, to insure uniformity of motion by attaching a shaft having pinions at regular intervals, to the floor of the chamber. The pinions worked racks fastened to spuds which were hinged to the upper end of the lower leaf. By this arrangement the motion of the leaves revolved the shaft and moved the spuds simultaneously. A somewhat similar arrangement of racks and pinions has been experimented with at the Davis Island Dam on the Ohio.\* The amount of head required for this purpose depends evidently upon the correctness of the design of the gate.

As regards the width of pass which can be closed with one bear-trap gate, the question has not yet been determined. Maj. William L. Marshall, U. S. A., and other engineers who have been studying this problem, have devised means which will probably permit bear-trap gates of considerable length to be constructed. Mr. William Martin, U. S. Ass't Engineer, who experimented with the bear-trap dam at Davis Island, states:† "I am firmly of the opinion that the old-style bear-trap, properly proportioned and built in a substantial manner, reducing leakage to a minimum, is capable of successful use in spans up to lengths from 200 to 300 feet."‡

**DuBois Gate (Fig. 109).**—In 1862 Mr. DuBois, of Williamsport, Pa., patented a modification of a bear-trap gate. His invention consisted in joining the two leaves by a hinge placed at the apex. The lower leaf was also hinged to the foundation, but the foot of the upper leaf was not attached and was to slide on the foundation during the lowering of the

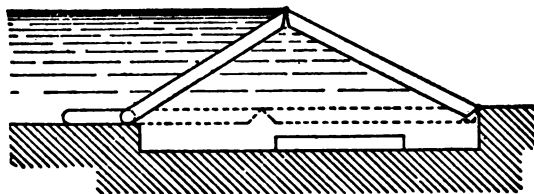


FIG. 109.—DUBOIS GATE.

gate. By this arrangement the friction existing between the leaves in the old-style gate is simply transferred to the bottom of the upper leaf. As this leaf has to slide back under the full head during the lowering the advantage gained by placing the hinge at the apex is neutralized. The DuBois gate is, therefore, not much of an improvement and can only be considered as a modification of bear-trap gates.

**Carro Gate (Fig. 110).**—A French engineer, M. Carro, invented in 1870 a gate which is very similar to that of DuBois. The leaves are hinged at the apex, but both slide on the foundation during the lowering of the gate, the motion being limited by links fastened to the lower leaf and to the foundation. To prevent drift and sediment from interfering with the

\* Journal of the Association of Engineering Societies, Vol. XVI., p. 209.

† *Ibid.*

‡ A bear-trap gate 160 feet wide has been constructed for the Chicago Drainage Canal. (See *Engineering News*, March 24, 1898.)

sliding of the upper leaf, a special leaf, hinged to the foundation and bearing against the upper leaf, is placed as a screen.

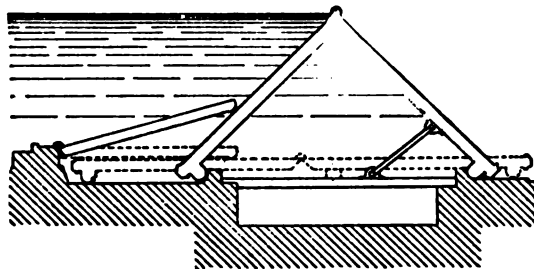


FIG. 110.—CARRO GATE.

**Girard's Gate (Fig. 111).**—In 1868 M. Girard took out a French patent for a gate of the bear-trap style, in which the sliding of the leaves was entirely done away with by placing one hinge at the apex and another near the middle of the lower leaf, which is fastened to a stay-

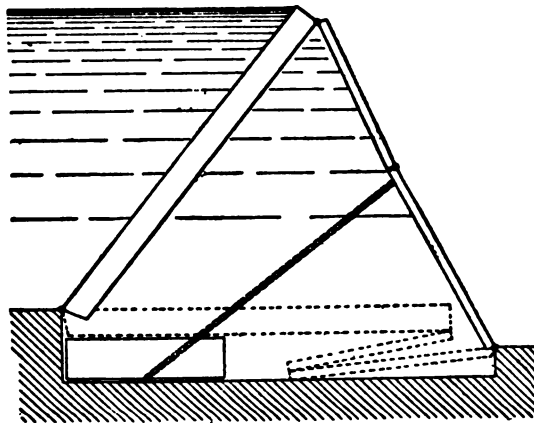


FIG. 111.—GIRARD GATE.

chain. By this arrangement the lower leaf is made to fold up when the gate is lowered. Although this invention constituted a decided advance in the construction of bear-trap gates, it does not appear to have been practically introduced or to have had its merits appreciated.

**Brunot Gate.**—The Hon. Felix R. Brunot, of Alleghany, Pa., patented in 1867 a sluice-

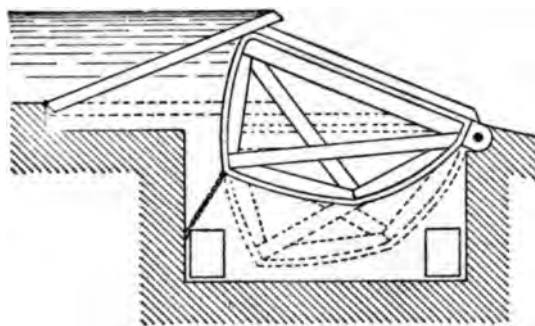


FIG. 112.

BRUNOT GATE.

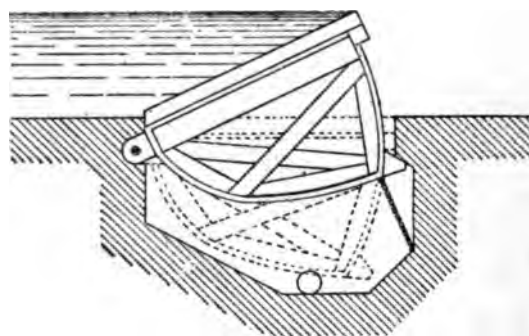


FIG. 113.

gate for dams and locks which consisted of a bear-trap gate having its lower leaf moved by a pontoon (Fig 112). In a later design the lower leaf was dispensed with, the pontoon being

placed directly under the upper leaf (Fig. 113). Two means of operating the gate were proposed. The first consisted in floating or sinking the pontoon in a conduit in a manner very similar to that proposed by M. Krantz (page 334). The second, which was probably the better plan, consisted in changing the buoyancy of the pontoon by admitting or pumping out water. A turbine-wheel, placed in a well in the abutment, and worked by the head of the upper pool, was to furnish the power for pumping.

**Parker Gate (Fig. 114).**—This gate, which was patented in 1887 by Thomas Parker, Menominee, Wis., is really the Girard gate turned around so that the upper instead of the lower leaf has a hinge near its middle. To prevent drift, etc., from interfering with the folding of the upper leaf, a special leaf, called an "idler," is introduced. It is hinged at the apex. Its bottom edge slides on the floor up-stream during the lowering of the gate, but as the pressure on both sides of the idler is the same, the friction caused by the sliding is insignifi-

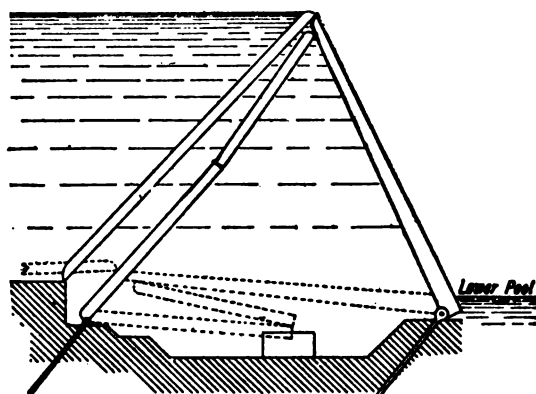


FIG. 114.—PARKER GATE.

cant. Grated openings are provided in the idler to permit the water to circulate freely around it. Most of the defects of the old style bear-trap gate are overcome in Mr. Parker's device. The length of the gate is reduced, the friction due to sliding is eliminated; the gate is obliged to rise uniformly; it is not stopped suddenly, and the idler prevents all trouble from drift. A number of these gates have already been constructed and have answered all the requirements. The largest one of these gates thus far constructed is the one built in 1892 for the Muscle Shoals Canal in Tennessee. It is 40 feet long and 8.5 feet high.

Mr. Parker designed, also, some of his gates to be used in a reversed position, with the hinge in the down-stream leaf.

**The Lang Gate (Fig. 115),** patented by Mr. Robert A. Lang, of Eau Claire, Wis., in 1890, was intended to be an improvement on the Parker gate. In Lang's gate the idler is made an essential part of the device and the upper part of the upper leaf is dispensed with, rods or chains taking its place. In this gate we have sliding friction again, viz., between the bottom of the idler and the upper leaf. Of course, it may be much reduced by using rollers. It is claimed that when the friction is at its maximum it is overcome by the weight of that part of the gate which is suspended in air. Engineers are still divided in opinion as to whether the Lang gate is really an improvement on the one devised by Parker. Further experience will have to settle this question.

A number of Lang gates, 20 to 80 feet long and 7 to 14 feet high, are now in use in the United States.

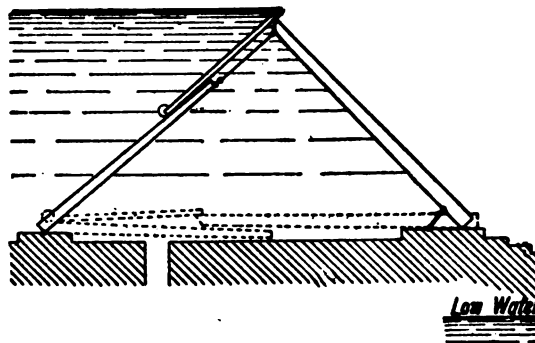


FIG. 115.—LANG GATE.

**Marshall Gate.**—Fig. 73 shows one form of a gate invented and patented in 1895 or '96 by Major William L. Marshall, Corps of Engineers, U. S. A. It differs in two essential

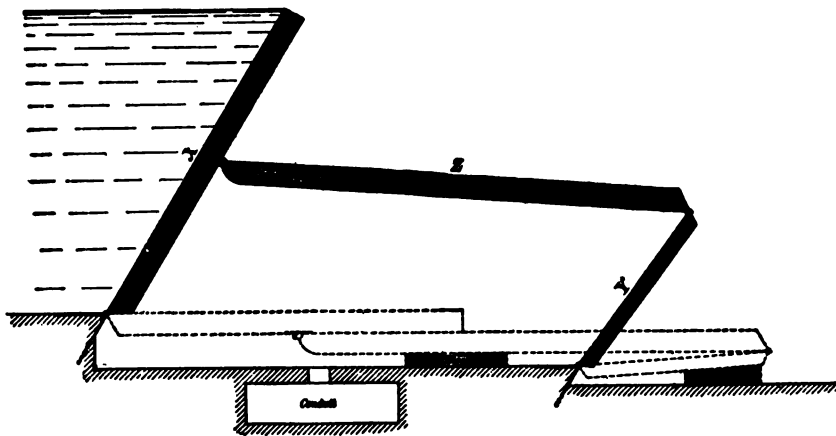


FIG. 116.—MARSHALL GATE.

points from the other types of bear-trap gates described in this chapter: 1st. The hinge joining the leaves is placed near the middle of one of the leaves instead of at its end; 2d. The hydraulic chamber under the leaves has a quadrangular instead of triangular cross-section, all of its angles being salient.

The arrangement of this gate makes it very flexible and does away with the necessity of restraining chains or stops.

Besides the gates mentioned above, other similar devices of little or no merit have been patented.\* For a fuller discussion of this subject, including theoretical investigations, we must refer the reader to the series of papers published in the *Journal of the Association of Engineering Societies* for June, 1896. An article on bear-trap gates, written by Capt. H. M. Chittenden, U. S. A., was published in the *Engineering News* for February 7th, 1895.

\* Wood, in 1871; Werner, in 1873; and Smith in 1875.

## CHAPTER IV.

## STONEY ROLLER SLUICE-GATES, ROLLING DAMS AND BUTTERFLY DAMS.

**Stoney Roller Sluice-gates.**—This type of sluice-gate is adapted for closing large openings in movable dams. It has been used with a depth of water of 30 feet for openings 30 feet wide and for lesser depths for widths up to 80 feet. The gate moves in vertical grooves in masonry piers on trains of rollers, which are independent both of the gate and of the pier. The rollers have their bearings in two vertical side-bars, at the top of which a loose sheave is placed. A chain or wire rope passes around this sheave and has one end attached to the sluice-gate, while the other end is fastened to some fixed point on the service-bridge connecting the piers. By this arrangement the train of rollers is made to move half as fast as the gate, which compensates for the gates moving on the diameter of the rollers while the rollers move on their radii. The roller trains are usually counterbalanced by weights. Each gate is generally suspended by link chains or by two or more screw-rods from a service-bridge built from pier to pier. The rods are located in a vertical plane passing through the centre of gravity of the gate. Their upper ends engage with nuts, which are supported on anti-friction bearings on the service-bridge. The gates are partly operated by counterweights amounting to 75–80 per cent of the weight of the gates and powerful gearing, arranged to be worked either by hand or by power, serves to revolve the nuts and thus to raise or to lower the gates. By the arrangements described above the friction is so reduced that gates subjected to a water-pressure of up to 400 tons can be easily moved by hand.

The gates themselves may be made of wood or iron, the latter material being usually preferred. When used for considerable widths a water-tight face is made of wood or sheet iron and beams, and this facing is stiffened by cross-beams or trusses, placed at intervals horizontally on the down-stream side of the facing, in order to withstand the pressure of the water. Water-tight joints are obtained by letting the gates bear on the wooden sills and by placing iron rods or pipes on the up-stream side in the grooves in the masonry in such a manner that they are jammed by the water-pressure into the angles formed by the gates with the piers.

Stoney sluice-gates were first constructed in 1883 by the inventor, Mr. F. G. M. Stoney of London, at Belleek, Ireland, in connection with the Lough Erne Drainage Works.\* In this case four sluice-gates were placed between masonry piers in order to control the outfall from a chain of lakes. Each gate is  $14\frac{1}{2}$  feet high and closes an opening of 29 feet 2 inches,

---

\* See *Engineering*, London, September 19, 1884.

the distance between the roller bearings being 31 feet. A clear lift opening of 9 feet can be obtained. The gates are made of plate iron and beams, and each gate is strengthened by two trusses, placed horizontally across the down-stream face of the gate. The rollers run between vertical rails carried on the ends of the sluices and fixed in grooves in the masonry piers. Both rails can be adjusted to allow the rollers to obtain fair bearings on them. Each gate can be raised by one man without difficulty, although it has to sustain a water-pressure of 80-100 tons. The gates have proved to be so satisfactory in every respect that many others of the same kind have since been constructed.

Thirty Stoney gates were constructed for the Manchester Sea Canal.\* They all close openings 30 feet wide with the exception of two gates which are used for widths of 20 feet. The lifts of these gates vary from 13 to 20 feet, and some of the gates are designed to withstand a head of 26 feet.

In 1892-94 a weir and lock were constructed at Richmond, England, to control the tide-flow of the river Thames.† A foot-bridge having three centre spans of 66 feet and



FIG. 117.



FIG. 118.

two shore spans of 50 feet was built across the river. Stoney gates are placed in the three central spans, one of the shore spans being occupied by a lock, while the other is used for a boat incline. Each gate is 12 feet deep by 66 feet wide and weighs 32 tons. It is formed of a plate structure stiffened on the down-stream side by bowstring plate girders. Although each gate has to sustain a water-pressure of about 100 tons, it can readily be raised to the full height by hand by two men in seven minutes. In order to get the gates out of sight, when raised, their guides were so arranged as to turn the gates horizontally under the bridge as they are raised. This is done automatically by the guides. The foot-bridge is divided into two paths 16 feet apart, which are joined by platforms at the piers. The gates, when raised, lie in the space between the two foot-paths.

\* See *Engineering*, London, January 26, 1894 (special number on the Manchester Sea Canal).

† See *Engineering*, London, January 10, 1896.



DAM FOR HYDRO-ELECTRIC PLANT AT BEZNAU, SWITZERLAND.



DAM FOR HYDRO-ELECTRIC PLANT AT BEZNAU, SWITZERLAND







DAM FOR HYDRO-ELECTRIC PLANT AT HAGNECK, SWITZERLAND.



DAM FOR HYDRO-ELECTRIC PLANT AT HAGNECK, SWITZERLAND, SHOWING STONEY SLUICE-GATES.



A number of Stoney sluice-gates have been placed in Switzerland in weirs built across the rivers Aar, Rhone, and Rhine. At Chevres, near Geneva, the gates, which were designed by Mr. Stoney himself, are about 30 feet square. They are counterbalanced so that two men can raise them quickly. In this case 4-inch gas-pipes are used instead of solid rods to obtain water-tight joints at the sides of the gates. On Plates EE and FF we give views of the weirs at Beznau and Hagneck, Switzerland, in which Stoney gates are used. On Plate C the details of the gates for the former weir will be found. Fig. 117 shows how the joint-rods are attached to the Beznau gates, and in Fig. 118 one of the chains which are used in this case instead of screw-rods for suspending the gate is shown.\*

The following table gives the dimensions of some of the principal Stoney sluice-gates:

STONEY ROLLER SLUICE-GATES.

Location.	When Constructed.	Number of Gates.	Dimensions of Gates.				On River.
			Height.		Clear Opening.		
			Metres.	Feet.	Metres.	Feet.	
<i>Great Britain:</i>							
Belleek, Ireland.....	1883	....	....	14.5	....	29.2	
Manchester Canal.....	1892-94	....	....	13-26	....	20-30	
Richmond, England.....	1892-94	....	....	12	....	66	
Glasgow, Scotland.....	.....	3	....	12	....	80	
<i>Switzerland:</i>							
Hagneck.....	1895-97	{ 2	6.5	....	10	....	Aar
Beznau.....	1898-1900	{ 1	3.0	....	12.5	....	Aar
Chevres.....	.....	6	6.3	....	16	....	Rhone
Rheinfelden.....	1895-98	....	....	27.9	....	32.8	
Lauffenburg.....	Begun in 1906	{ 3	5.0	....	10.0	....	
Electrical Works at Zurich..	Begun in 1906	{ 1	17.0	....	20.0	....	Rhine
		{ 2	12.5	....	14.5	....	
		{ 1	12.5	....	20.0	....	Albula
		....	8.0	....	15.0	....	
<i>Africa:</i>							
Assuan Dam.....	1898-1903	25	....	11.5	....	6.6	Nile
Assiout ".....	1898-1903	111	....	16	....	16.4	Nile
<i>Asia:</i>							
Perlar Dam.....	.....	1	....	12.8	....	9.5	
<i>America:</i>							
Sault Ste. Marie Canal.....	.....	4	....	26	....	48	
Chicago Drainage Canal.....	.....	8	....	20	....	30	
Minneapolis.....	1906	...	....	18	....	16.3	

NOTE.—The plans were approved in 1906 for the following Stoney sluice-gates in Switzerland: At Rheinau on the Rhine, seven gates, 7 metres high, with openings of 12 metres, and at Augst-Wylen on the Rhine for eleven gates, 9 metres high, having openings of 16 metres. Another Stoney sluice-gate is being constructed at Kander-Simmen, but we have not been able to ascertain its dimensions.

In the Assuan and Assiout dams, built in Egypt in 1898-1903, Stoney sluice-gates were placed as follows: In the Assuan Dam, twenty-five gates, 6.56 feet wide by 11.48 feet high; in the Assiout Dam, one hundred and eleven gates, 16.4 feet wide by 16 feet high.

In 1899 a Stoney sluice-gate, 9 feet 6 inches wide by 12 feet 9 inches high, was

\* The information and illustrations given about Stoney gates in Switzerland were supplied to the author by Prof. K. E. Hilgard of the Federal Polytechnicum, Zurich, Switzerland.

erected in India at the head of the outlet-tunnel of the Periar Reservoir.\* The gate works in a cast-iron framework built into a masonry sluice-chamber,  $15\frac{1}{2}$  by 15 feet in plan. The sill of the gate is 37 feet 3 inches below the full level of the reservoir. The gate is composed of a  $\frac{3}{4}$ -inch steel plate, reinforced by fourteen  $6\times 12$ -inch steel beams, which transmit the load to the end castings, which rest on twenty pairs of rollers. The gate, which is counterbalanced to the extent of two thirds of its weight, is operated by a screw lifting-gear consisting of a  $3\frac{1}{2}$ -inch double-threaded steel screw, keyed to a massive bevel-wheel, which is worked by a winch. The screw is protected from the weather and dust by a shield-tube. A strong sloping screw is provided on the up-stream side of the gate to prevent injury from driftwood, etc.

In the United States Stoney gates have been used at the head-works of the Michigan-Lake Superior Power Company's canal at Sault Ste. Marie, Mich., for the regulating works of the Sault Ste. Marie River, and in the Chicago Drainage Canal. In the latter canal provision was made for 15 Stoney gates,† each 20 feet high and 30 feet wide in the clear between piers, and also for a bear-trap gate 160 feet wide, for regulating the discharge of the main channel into the tail-race leading to the Desplaines River.‡ Three timber-and-steel Stoney gates, 18 feet high, closing openings of 16 feet 4 inches, were designed and erected by James W. Rickey,§ M. Am. Soc. C. E., as head-gates of the canal of the St. Anthony Falls Water Company at Minneapolis, Minn.

**Rolling Dams.**—Within the past few years a new style of movable dam has been introduced in Germany. It consists of an iron or steel pipe, usually made cylindrical, which closes the opening in a fixed dam when required and which, when the dam is to be opened, can be rolled up masonry inclines at the abutments, to a sufficient height, by simple machinery. This style of dam was invented and patented, both in Europe and America, by Mr. Max Carstanjen, Chief Engineer of the Gustavsburg Bridge Works,|| near Mainz, Germany. The first dam of this kind was constructed by the bridge company, just mentioned, on a branch of the river Main, near Schweinfurt, Bavaria, and was described by Mr. Carstanjen in a paper, and illustrated by a model, presented to the Ninth International Congress on Inland Navigation, held in 1902, in Düsseldorf, Germany. Since then eight other rolling dams have been built by the same bridge company in Germany, Austria, France, and Italy.

The principal advantages claimed for rolling dams are as follows:

1. The closing or opening of a gap in a fixed dam by means of a single body, requiring no intermediate support.
2. Applicability to wider and deeper openings than those hitherto closed by movable dams.
3. Simplicity of construction and great strength.

---

\* See Administration Report on the Irrigation Branch of the Public Works Department in the Madras Presidency for the year 1898-99.

† To the present time only eight of these gates have been put in, the openings for the other seven being temporarily closed.

‡ Details of these Stoney gates and their hoisting machinery are given in *Engineering News* of November 21 and December 12, 1895.

§ The author is indebted to Mr. Rickey for information furnished about these and other Stoney sluice-gates.

|| A branch of the "Vereinigte Maschinenfabrik Augsburg und Maschinenbaugesellschaft Nürnberg, A. G."

PLATE GG.



ROLLING DAM AT SCHWEINFURT, GERMANY. THE ROLLER RAISED.



ROLLING DAM AT SCHWEINFURT, GERMANY. THE ROLLER LOWERED.



4. Facility and quickness of operation by simple machinery.
5. A minimum resistance to motion in opening or closing the dam, as only rolling friction has to be overcome.
6. Great water-tightness.
7. Adaptability for rivers carrying much drift and ice.
8. Security of the roller in winter.
9. A gain in the time the dam can be kept closed, owing to the quickness with which the roller can be raised.

Prof. K. E. Hilgard, M. Am. Soc. C. E., expressed the opinion, in a paper on rolling dams, read in 1904 at the International Engineering Congress at St. Louis, that rolling dams could be used for openings of 150 feet width or more and for depth of water up to 30 feet.

**Rolling Dams at Schweinfurt, Bavaria.**---The first of these two dams was built in 1901-1902, on the Sau, a branch of the river Main, which serves as a raceway for the latter. The rolling dam, or "roller" as we shall call it, consists of a riveted steel-plate pipe, 4.136 metres (13.57 feet) in diameter at the ends, which closes an opening of 18 metres (59 feet) in the clear. Steel ropes are slung around the ends of the roller, which are made cylindrical, and serve for lowering or raising the roller on masonry inclines at the abutment like a barrel or heavy pipe. The steel ropes wound around each end of the roller are fastened thereto at one point and are also slung around a guide-pulley and a winch-drum. The operating machinery consists of two ordinary winches with self-locking worm-gears, one at each abutment. The winches are operated by hand and it takes 12 men four hours' time to raise the roller to its highest elevation.

A large cog-wheel is attached at each end of the roller and engages with a rack-rail laid upon the inclined plane. The cog-wheels can be locked in their lowest position by means of stops, which release the tension on the ropes. The cog-wheels, racks, and track are made of strong construction and are so designed that foreign bodies getting in them will drop out or can easily be removed.

The racks and track are placed in recesses in the abutments, and a stone stairway is constructed along each track, which makes it possible to inspect it at all times.

In order to reduce the buoyancy of the roller, its body is given a pear-shaped cross-section, except at the ends, which, as already stated, are made cylindrical. At the closing edge of the roller an oak timber is attached which comes in contact with the sill of the dam. By means of the steel ropes a certain pressure can be exerted on the oak timber, and a practically tight bottom joint is thus secured. Leather straps are wound around the ends of the roller and bear against smooth masonry, which makes the sides also sufficiently water-tight. The area of the cross-section is so designed that the roller in moving up the inclines recedes from the position it occupied while closing the dam. It does not therefore displace any sediment, débris, ice, or other floating bodies, nor any additional water. In fact, its upward motion is assisted by the water. A deposit of débris or rubbish, etc., is not likely to form on the sill, owing to the great velocity of the water as the dam is being closed.

Inside of the roller a smaller pipe open at each end is placed. It forms the ballast-tube and is filled by the backwater as soon as the dam is immersed to a sufficient depth

to require additional weight to overcome its buoyancy. When the dam is raised the water flows out of the ballast-tube and thus reduces the weight.

The water rarely flows over the dam, and the top of the roller answers generally as a foot-bridge across the river.

*The roller dam across the river Main* (Plate GG) was constructed in 1903.

The roller, which is 2 metres in diameter, closes an opening of 35 metres (114.8 feet) in the clear. In this case the whole roller was made cylindrical. It rests on a fixed masonry dam of ogee section, into the crest of which an oak timber is sunk to secure a tight joint, and is operated by machinery placed on one bank only; but a guiding rack is provided in recesses of each abutment, and triangular fillets are attached at each end of the roller. The latter are tightened against the masonry by hempen ropes.

The operating machinery is only placed on one side of the dam, and on the other side a link chain is provided into which the corresponding teeth at the end of the roller engage to prevent any slipping. Should both ends become disengaged, the roller will be prevented from descending by the steel ropes.

The profile of the rack track is a cycloidal curve compounded of portions of circles.

Owing to the fact that the roller of the dam has a small diameter compared to its length it was found to warp upwards when the sun shone on its top, thus permitting a small flow of water under the dam. This matter was remedied by giving the crest of the fixed dam a slight camber, to which the roller conforms by deflection at its end.

The two dams described above are arranged so that they can be operated by hand or by electricity.

**Butterfly Dam.\***—An emergency butterfly dam is being built for the Chicago Drainage Canal and is to be placed in the extension of the main channel of the Sanitary District near the present controlling works. The dam will consist of a steel leaf, about 184 feet long, and 30 feet high, constructed of horizontal riveted girders, with an up-stream face of plates riveted to the girders. The leaf will have, at its centre, a lower and an upper pivot. The former will be secured in a steel anchorage, bedded in concrete in the floor of the canal, and the latter will be held in position by a riveted brace span above the leaf. The outside and the inside diameter of the lower pivot are respectively 2 feet 6 inches and 1 foot 2 inches. The brace span will be located on the centre line of the main channel and parallel therewith. Each end is to rest on a masonry protection and anchorage. These protections divide the main channel into two channels, each 80 feet wide in the clear. When opened the leaf will be parallel with the channel and directly beneath the brace span; when closed it will form a dam across the main channel, which will divert the water through the present controlling works. Details of the construction of this butterfly dam have not yet been published.

---

\* *Engineering World*, November 30, 1906.



## CHAPTER V.

## RECENT MOVABLE DAMS.

In Europe one of the most important systems of movable dams has been recently established in Bohemia to maintain slack-water navigation between Aussig, on the Bohemian Elbe, and Prague, on the Moldau, a tributary of the Elbe.\* The system, which was approved by the government in December 1895, will contain, when completed, thirteen locks—seven on the Elbe and six on the Moldau—and twelve movable dams, some closed only with needles and the others with needles and Boulé gates. The lifts of the locks vary from 6.2 to 17.7 feet, and the lengths of the pools vary from  $2\frac{1}{2}$  to 8 miles.

The largest boats navigating the rivers are 230 feet long, 36 feet wide, and draw 6 feet of water. Two harbors of refuge, capable of sheltering 180 large boats, are included in the project for protecting craft from floods and ice.

In 1902 the first four dams were completed and in operation. They are all provided with fish-screens. Short descriptions of these dams are given below.

**Dam No. 1, at Troja**, just below Prague, was commenced in 1899. It has two openings of 122 feet and one of 153 feet in width, which are closed by needles 12.2 to 15.3 feet long, supported by fixed bars. The general construction of the dam and of the lock is similar to that of Dam No. 2. The lock has a lift of 17.7 feet. A chute 39 feet wide and 1,400 feet long is provided for rafts. Its slopes vary from 1 in 200 to 1 in 100.

**Dam No. 2, at Klecan**, begun early in 1897, has two weirs of 127 feet each, and a pass of 131 feet, built principally with granite foundations and with wide aprons to guard against undermining. The openings are all closed with needles, supported by swinging escape-bars on the Kummer system.

The trestles, which are 12.1 to 15.4 feet high, are placed 4 feet 1 inch apart, and connected to each other by fixed chains. A sill 2 feet high protects the trestles when down. The aprons, or floors, are of iron and hinged to the trestles.

The needles are of larch-wood and have hook-shaped iron handles. They are 10.8 to 13.0 feet long and measure 3.7 to 4.7 inches square, their weight varying, when wet, from 46 to 72 pounds.

A chute for rafts, 39 feet long, is built on the right bank. It can be closed by a needle dam.

The lock is 722 feet long over all and is divided by a pair of gates into two chambers, one about 220 feet long and 36 feet wide, and the other about 460 feet long and  $65\frac{1}{2}$  feet wide.

---

\* See "The Improvement of Rivers," by B. F. Thomas and D. A. Watt, Members Am. Soc. C. E., and also "La Canalisation de la Moldau et de Elbe en Bohême," V. Rubin, Prague, 1900.



**Dam No. 3, at Libschitz**, has two openings—a weir 160 feet long, with 10.4 feet of water on the sill, and a pass 213 feet long, with 14.7 feet of water on the sill. The weir is closed with needles 12½ feet long, which are provided with hooks that pass over the escape-bars, as in the dam at Joinville-sur-Marne. The trestles, which are 13.7 feet high, are placed 4 feet apart.

The pass is closed by Boulé gates, supported by trestles formed of channel-irons and maneuvered by means of a small traveling crane. Each bay is closed by five gates—four lower ones, each 3¼ feet high, and one top one, 1 foot 7 inches high. The lowest gate is 5 inches thick. The trestles are 4 feet 1 inch apart and 19.7 feet high.

The dam has a lock and a raft chute similar to those of Dam No. 2.

**Dam No. 4, at Mirowitz**, was begun in 1900. It has two needle weirs and a pass 184 feet wide closed by Boulé gates.

**In the United States** an extensive system of movable dams is being constructed on the Ohio River and some of its tributaries. Two dams have been completed on the Ohio River, viz., one at Davis Island, described on page 333, and another at Beaver, Pennsylvania, known as Dam No. 6, which is described in this chapter. Several other dams on this river, designated as Dams Nos. 2, 3, 4, and 5, are under construction and will soon be completed. All of these dams are of the Chanoine type and have drift-chutes and regulating weirs of bear-traps.

Eight Chanoine wicket dams have been constructed on the Kanawha River, in West Virginia, and one is being built on the Alleghany River. On the Big Sandy River a needle dam has been built, which is described on page 309. Besides the movable dams a number of fixed dams with locks have been built on the affluents of the Ohio River, to provide slack-water navigation.

When the whole proposed system has been completed slack-water navigation will be provided for from Pittsburg to Cairo, a distance of over a thousand miles.

Only a few movable dams have thus far been built or projected outside of the Ohio River system, the most notable exception being a drum dam on the Osage River.

**The Beaver Movable Dam**,\* officially designated as Dam No. 6 of the Ohio River and sometimes called the Merrill Dam (after the late Col. William E. Merrill, Corps of Engineers, U. S. A.), was constructed in 1892 to 1905, about 31 miles below Pittsburg. The length of time consumed in the construction of this dam was caused by lack of funds, failing contractors, changes of methods due to new laws, loss of time on account of floods, etc.

The lock of the dam, which is located on the right bank of the river, is 600 feet long between gates and 110 feet wide. The gates are of the rolling type, necessitating deep recesses or slips behind the land wall of the lock, somewhat in excess of the width of the lock.

The movable dam begins at the river lock wall, at about the centre of the lock. It has a length of 1,000 feet, 240 feet of which is operated automatically. For the first 600 feet from the lock the dam is formed of Chanoine wickets. This part forms the navigable pass, the sill being as low as the river-bed above and below the dam. The sill protects the wickets when they are lowered.

---

\* *Engineering Record*, March 11, 1905.



Next to the navigable pass come two bear-trap weirs, each 120 feet long, designated respectively as Weirs No. 1 and No. 2. A pier 12 feet wide separates the navigable pass from Weir No. 1, and the latter is separated from No. 2 by a pier 14 feet wide. A third weir, No. 3, 120 feet long, comes next in the dam, being separated from No. 2 by a pier 14 feet wide. Weir No. 3 is, however, closed by trestles of the A-frame type forming what is known as a Thomas A-frame dam.

The floor of the dam, as the top of the fixed part is called, is composed principally of 12×12-inch oak timbers securely bolted together and built into the concrete foundation. The concrete foundation is 12 feet wide, and on its up-stream side sheet-piles are driven wherever possible. The movable dam proper is secured to this foundation. The Chanoiné wickets are constructed according to the general plan described on page 327. Each wicket is 3 feet 9 inches wide, a space of 3 inches being left between adjacent wickets to prevent their fouling each other during maneuvers. The natural flow of the river passes through these spaces, which are closed by needles, when necessary, to maintain the required depth of water. The navigable pass is maneuvered by means of a derrick boat provided with a double-drum hoisting-engine.

The bear-traps are made of a combination of wood and steel. The A-frame dam that closes Weir No. 3 is built according to the general plan described on page 323.

The work of building the dam was begun on June 26, 1892, and in August 1904 the dam and lock were opened for navigation.

MROU

## APPENDIX.

---

### SPECIFICATIONS FOR THE NEW CROTON DAM.

(1) **Plans.**—The plans referred to in these specifications are twelve (12) in number, entitled "The Aqueduct Commission, Contract Drawings, New Croton Dam at Cornell Site," Sheets 1 to 12 inclusive, and signed by the Chief Engineer, and dated May 2d, 1892.

They show the location of the work, and its general character. During the progress of the work, such working plans will be furnished from time to time by the Engineer, as he may deem necessary.

(2) **Test-pits and Borings.**—Test-pits and borings have been made to ascertain the nature of the ground where the work is to be built; should the character, location and extent of the various materials be found to differ from what is indicated by the test-pits and borings, the Contractor shall have no claim on that account, and it is expressly understood that the Corporation of the City of New York does not warrant the indications of the tests to be correct.

(3) **General Description of the Work.**—The Dam is to be erected across the valley of Croton River, about  $3\frac{1}{2}$  miles below the present Croton Dam, approximately at such point of the tract of land designated as Cornell Site as is indicated on sheet No. 3. The central part of the Dam is to be wholly of masonry built on the solid rock, as shown on the plans, or as may be hereafter ordered by the Engineer. On the right bank of the river a deep gate-chamber and beyond it a long spillway or overflow, with a channel connected therewith following the contour of the side-hill, all of masonry, are to be built. The water flowing over the spillway is to be conducted to the bed of the river below the Dam by means of a channel excavated in the side-hill. On the left bank of the river and in continuation of the central part of the Dam, an embankment containing a central masonry wall, built on the solid rock, is to be erected; a gate-chamber is to establish a communication between the old Aqueduct and the proposed Reservoir. Heavy paving or sodding is to protect the surfaces of the embankments.

A channel is to be excavated for the purpose of diverting the waters of the river before work can be begun near its present bed, and roads must be built to turn and maintain the public traffic, which must not be interrupted by the operations of construction.

All earth, rock and timber work, all iron work, all masonry work and all other work of a permanent or temporary character, necessary to complete the Dam, are described in this agreement.

During the progress of the work below the level of the river, it will flow in the temporary channel provided for it. As the Dam rises to a higher level, openings shall be left in the masonry to accommodate the flow of the river; but, inasmuch as in heavy freshets the said openings would not be sufficient, the water may rise behind the Dam, and, as it might overtop it, a part of the Dam masonry nearest to the river-bed is to be always left at a lower level, at a point where the fall of the water cannot cause any permanent injury.

All work, during its progress, and on its completion, must conform truly to the lines and levels to be given hereafter and determined by the Engineer, and must be built in accordance with the plans and directions which shall be given by him from time to time, subject to such modifications and additions as said Engineer shall deem necessary during the prosecution of the work; and in no case will any work which may be performed, or any materials furnished in excess of the requirements of this contract or of the plans, or of the specifications, be estimated and paid for unless such excess shall have been ordered by the Engineer, as herein set forth.

The Contractor is to furnish all materials (except such as may be obtained from the excavations), and all tools, implements, machinery, and labor (necessary or convenient for doing all the work herein contracted for, with safety to life and property in accordance with this contract, and within the time specified herein) required to construct and put in complete working order the work herein specified, and is to perform and construct all the work covered by this agreement; the whole to be done in conformity with the plans and these specifications; and all parts to be done to the satisfaction of the said Aqueduct Commissioners.

(4) **Methods and Appliances.**—The Contractor is to use such methods and appliances for the performance of all the operations connected with the work embraced under this contract as will secure a satisfactory quality of work and a rate of progress which, in the opinion of the Engineer, will secure the completion of the work within the time herein specified. If, at any time before the commencement, or during the progress of the work, such methods or appliances appear to the Engineer to be inefficient or inappropriate for securing the quality of the work required or the said rate of progress, he may order the Contractor to increase their efficiency or to improve their character, and the Contractor must conform to such order; but the failure of the Engineer to demand such increase of efficiency or improvement shall not relieve the Contractor from his obligation to secure the quality of work and the rate of progress established in these specifications.

#### PROTECTIVE WORK.

(5) **Highways.**—As the present highway is to be interrupted at the beginning of the work, new highways, bridges and culverts must be built first, to turn and maintain safely the public traffic, also all fences and other appurtenances necessary for public safety.

(6) **Diverting Channel and Temporary Dams.**—Before operations can be begun about the bed of the river, an artificial channel must be provided for the river. It is to be excavated in the side-hill, and two or more temporary dams are to be built in connection with it for the purpose of excluding the water from the portions of the valley into which excavations are to be made. The size and disposition of these structures are indicated on the plans.

(7) **Responsibility of the Contractor.**—The Contractor shall do all other work needed to protect his work from water; he shall erect all temporary dams, coffer-dams, sheet-piling and other devices, take care of the river, and shall be responsible for all damage that may be caused by the action of water, whether from negligence or any other cause. Such damage is to be repaired, and the work must be restored and maintained at his cost.

(8) All earth and rock excavation, masonry, timber and other work, temporary or permanent, for the purpose of protecting the work from the river, provided that they are ordered or approved by the Engineer, are to be paid for at the prices stipulated in this contract. All work of this character is to be removed by the Contractor at his own expense, if so ordered by the Engineer.

The responsibility of the Contractor as to damage caused by the inefficiency of the protective work shall cease, however, if such damage is caused by the river at a time when the flow of the river attains such volume as will cause it to rise to a height of more than eighty-one inches above the stone crest of the present Croton Dam, such height being the greatest recorded by the City authorities.

Such damage as may be caused under the circumstances just stated shall be repaired by the Contractor as soon as practicable, under the direction of the Engineer, who shall appraise the cost of such work of repairs, and the amount of the same shall be paid to the Contractor on the certificate of the Engineer that the work has been completed to his satisfaction; and, after such certificate shall have been issued, the Contractor shall again become responsible for all damage that may be caused by the action of the water, in the same manner as is specified in clauses 7 and 8.

If such appraisal of the Engineer is not satisfactory to the Contractor, the said Contractor shall so state in writing to the Aqueduct Commissioners, and, thereupon, a Board of Arbitration, composed, 1st, of the Chief Engineer, or of such other person that the Aqueduct Commissioners may designate; 2d, of a person selected by the Contractor; 3d, of another person to be designated by the other two, shall proceed to appraise the cost of such damage, and their decision shall be final and binding on both parties, provided it is the unanimous decision of the three members of the said Board; but if the said decision is not unanimous, the appraisal of the Chief Engineer shall stand and become final and binding to both parties. And, on the certificate of the Aqueduct Commissioners that the said appraisal has been made in accordance with the stipulations of this agreement, the amount of said appraisal shall be paid to the Contractor. And the said appraisal, whether made by the Chief Engineer or by the said Board of Arbitration, shall include only the cost of the actual work done to repair the damage, and shall not include any alleged loss of profit or other loss due to the delay caused by such repairs, but an extension of time shall be granted to the Contractor

for the performance of his contract, equivalent, in the opinion of the Engineer, to the loss of time due to the interruption of the operations of construction on account of the said work of repairs.

(9) **Pumping.**—The Contractor is to do all the draining and pumping which shall be necessary for keeping the work free from water, and if at any time the Engineer is of opinion that, in order to maintain the slopes and sides of the excavations in proper order, it is necessary to remove the water from the ground outside of the limits of the excavations, the Contractor shall, at his request, sink the necessary pipes or wells to intercept the water, and place, maintain and work such pumping or other exhausting apparatus as shall be sufficient to properly maintain the said slopes and sides.

The cost of furnishing the necessary appliances and machinery, of working them, and of doing all the work connected with draining and pumping operations, is to be included in the prices bid for the various kinds of work which the draining and pumping operations are intended to protect.

#### SOIL.

(10) The soil is to be removed from the grounds where the Dam, embankments and other works are to stand and the excavations to take place, and wherever directed by the Engineer, and shall be deposited as directed or approved by him.

It shall be estimated as earth excavation clause O, item (c.),\* and if of proper quality, may be used afterward by the Contractor.

The slopes of the embankments and such other places as may be designated, shall be covered with soil which the Contractor may take from his spoil-banks or elsewhere; it must be of good quality and, after being rolled or otherwise compacted, it shall be measured in embankment and paid for as stipulated in clause O, item (a.).

The thickness of the soil shall be six inches or more as may be ordered.

#### SODDING.

(11) The embankments of the Dam and such other surfaces as may be designated by the Engineer, are to be sodded.

All the surfaces to be sodded are to be carefully graded, so as to make a true and even bearing for the sods to rest on.

The sods to be of good quality of earth covered with heavy grass, sound and healthy, and not less than one foot square, and generally of a uniform thickness of three inches (which sizes may be altered by the Engineer during the progress of the work); to be cut with a bevel on all sides, so that when laid they will lap at the edges; to be properly set so as to have a full bearing on their whole lower surface; to be padded down firm with a spade or wooden bat made suitable for the purpose; each sod is to be pinned with one wooden pin to each sod, not less than fifteen inches long, so as to be secured to the ground beneath it, and to be so laid that the upper surface shall conform to the true slope of the bank or ground, and to the lines given

\* Clause O of the contract contains the prices for the different items of work.



by the Engineer. No lean, poor or broken sods will be allowed in the work, but on the outside edges of the bank, sods may be cut to such size and shape as will make a proper finish to the same.

(12) The sodding that shall have been laid shall be well and carefully sprinkled with water as often as the Engineer shall deem necessary for the benefit of the work during its progress.

#### EARTH EXCAVATION.

(13) **Earth Excavation.**—The earth excavation is to be very extensive and, at many points, of great depths. It is to be made for the construction of highways, for the uncovering of the rock, for the preparation of the spaces into which masonry and other work is to be built, for trenches, and for any other work which the Engineer may order.

(14) **Measurements.**—All earth excavation is to be measured according to the lines and slopes established from time to time by the Engineer. The plans indicate in a general way the slopes of the excavations, but they will be modified during construction in accordance with the character of the materials encountered. When they are so modified, the Contractor shall conform to the modified lines given from time to time without extra compensation on account of such modification.

(15) **Depths.**—The depth at which the sloping excavations are to be abandoned and the vertical trenches are to be begun for the centre walls, will depend also on the character of the materials encountered, and cannot be fixed in advance.

(16) **Timbering.**—The timbering of all trenches must be done with great care and shall be conducted by skilful mechanics.

(17) **Disposal.**—The materials excavated must be deposited in such a manner, at such places, and at such distances from the excavations as shall be directed or approved by the Engineer.

All work done under this head is to be measured in excavation.

(18) **Prices.**—The prices herein stipulated for earth excavation (clause O, items (c.) and (cc.)) are to include the work of clearing and grubbing the grounds of all trees, stumps, bushes and roots, and the burning or otherwise disposing of the same; of sheeting and bracing, and of supporting and maintaining all trenches and pits during and after excavation; of all pumping, ditching and draining, and of disposing of the excavated materials.

(19) **What is Earth Excavation.**—All excavation of earth, hard-pan and other materials, including boulders not exceeding one cubic yard each, shall be classified and estimated as earth excavation and paid for at the prices herein stipulated (Clause O, items (c.) and (cc.)).

(20) **No Extra Haul.**—No extra haul shall be paid for materials excavated under this head.

(21) **Excavation for Highways.**—For the work of constructing highways all the materials shall be measured in excavation, including such as may be borrowed outside of the work, and the price bid (clause O, item (c.)) shall include the cost of disposing

of the excavated materials in forming the roadbed and in making the fills and embankments connected with the highways and with their appurtenances.

(22) **Two Prices.**—Two prices are to be paid for earth excavation. One price (clause O, item (c.)) for all earth excavation other than that made in vertical trenches. Another price (clause O, item (c.c.)) is to be paid for all excavations made in vertical trenches for the purpose of building therein the centre wall of the embankments and for the purpose of placing sheet-piling for the protection of river work.

#### REFILLING AND EMBANKMENTS.

(23) The work to be done under this head consists of all the earth and broken rock work necessary for refilling the excavations and for making embankments (except for construction of highways as hereinbefore specified, clause (21)).

(24) **Measurement.**—All the materials used for refilling and embankments are to be measured according to the dimensions of the spaces which are to be refilled and of the embankments in place.

(25) **Where Taken.**—The materials necessary for refilling and embankments are to be taken from the dumps formed during the process of excavation or from approved borrow-pits.

(26) **Extra Haul.**—Whenever the materials used for refilling and embankments are to be hauled a distance greater than three thousand feet measured on a straight line from the borrow-pit to the nearest point on the centre-line of the base of the Dam, an additional price equal to three per cent of the price stipulated for refilling and embankment (clause O, item (d.)), is to be paid to the Contractor for each yard for each one hundred feet that the said yard is hauled farther than the said three thousand feet.

(27) **How Made.**—The embankments for the main and temporary Dams shall start from a well-prepared base, stepped on sloping ground; all embankments and all refilling shall be carried up in horizontal layers not exceeding six inches in thickness; every layer to be carefully rolled with a heavy grooved roller, and to be well watered. The earth to be well rammed with heavy rammers at such points as cannot be reached by the roller. Special care shall be required in ramming the earth close to the sheet-piling and to the masonry, which shall always be kept at least two feet higher than the adjoining embankment, unless otherwise permitted. The embankments of the Dam shall be kept at an uniform height on both sides of the masonry during construction, unless otherwise permitted.

(28) Ample means shall be provided for watering the banks, and any portion of the embankment to which a layer is being applied shall be so wet, when required, that water will stand on the surface. The Contractor shall furnish at his own cost the necessary steam or other power for forcing the water upon the bank, if the Engineer find that other means of transportation and distribution of the water are not sufficient.

(29) **Extra Thickness of Embankments.**—The embankments of the Dam or any slopes that may be so ordered shall be formed with an extra width of twelve inches; this surplus quantity of earth shall be afterwards removed and estimated as excavation (item (c.)), and the surface left shall be dressed smoothly to receive the broken stones supporting the paving or the soil.

(30) **Quality.**—The earth used for the embankments shall be free from perishable material of all kinds and from stones larger than three inches in diameter, and it shall be of a quality approved by the Engineer.

(31) **Selected Materials.**—The Engineer shall decide upon the quality and character of the earth to be used at various places, and it must be selected and placed in accordance with his orders; the most compact material must be used on the up-stream side of the centre wall of the Dam embankments and for the refilling of the wall trenches; more porous material must be used for the embankments on the down-stream side.

(32) **Mixing.**—When the Engineer finds it necessary to mix the materials to be used for making embankments and for refilling, separate loads of the various materials designated by the Engineer, and in proportions to be determined by him, shall be deposited on the embankments at proper intervals; they will then be thrown with shovels or otherwise in such a manner as to effect a thorough mixture.

(33) **Borrow-pits.**—The borrow-pits must be acceptable to the Engineer, but the City shall not pay for the removal of boulders, trees, stumps and other things which are not acceptable for refilling and embankments.

(34) **Price.**—The price herein stipulated for refilling and embankments (clause O, item (d.)) is to include the cost of excavating and taking the materials used therefor from the dumps or from the borrow-pits, of supporting, draining and maintaining the excavations, of selecting, mixing and transporting the materials, of rolling and watering, and of doing all work necessary for placing the same as hereinbefore specified.

(35) **Broken Rock for Refilling and Embankments.**—All excavated rock taken from the excavation or from the places where it has been deposited, and used in the same manner as herein specified for refilling and making embankment, shall be classified under that head, and shall be paid for at the price stipulated (clause O, item (d.)).

#### ROCK EXCAVATION.

Rock excavation is to take place for the channel through which the river is to be diverted, for the spillway channel, for the foundations of the Dam, of the Gate House and of the centre wall, and wherever the Engineer may order it.

(36) **Rock Excavation Defined.**—Rock excavation is to include the excavation of all solid rock which cannot be removed by picking, and of boulders of one cubic yard or more in size and the removal of masonry.

(37) **Measurements.**—Rock is to be measured in excavation to the lines determined by the Engineer.

(38) **Stepping.**—In the wall and pipe trenches and in the excavations for the Dam, Gate House, overflow, spillway channel and other structures, the rock is to be shaped roughly in steps or other form that may be ordered by the Engineer.

(39) **Price.**—The price bid for rock excavation is to include the cost of supporting and maintaining the excavations, of pumping and draining, of disposing of the excavated materials as approved by the Engineer, and all other incidental expenses.

(40) **Explosives.**—All rock excavation in the wall trenches and at any other place designated by the Engineer is to be made with explosives of a moderate power under his directions, and not with high explosives. Black powder may be ordered by him to be used in special cases.

(41) **Surface of Rock Foundation.**—All rock surface intended for masonry foundation must be freed from all loose pieces, and be firm and solid, and prepared as directed by the Engineer.

(42) **Foundation.**—The rock excavation for the foundations is to be extended to such a depth and in such a manner as shall be ordered by the Engineer.

#### TIMBER WORK.

(43) Timber may be ordered used for platforms, flumes, channels, for permanent sheet-piling and for other permanent uses. It shall be of the size and placed in the manner ordered by the Engineer.

(44) All timber and lumber so used shall be spruce, sound, straight grained and free from all shakes, loose knots and other defects that may impair its strength and durability. Other wood may be accepted by the Engineer if, in his opinion, it is equally good for the particular place in which it is to be used. The price bid for timber shall cover all incidental expenses incurred for labor, or for tools or materials used in placing, securing or fastening it.

(45) No payment shall be made to the Contractor for lumber used for bracing, sheeting, scaffolding and other temporary purposes unless otherwise specified. All timber used for this purpose is to be removed by the Contractor at his own expense, and if any of it is left in the work, no payment shall be made for the same.

(46) **Measurement.**—Only timber work in place is to be measured and estimated. If any round timber is used and accepted, it shall be measured by multiplying the useful length of the stick by the average area of the two finished ends and taking eighty per cent. of the result.

(47) **Tongued and Grooved Timber.**—The timber to be used for sheet-piling in the foundations and other places may be ordered tongued and grooved. Such timber shall be furnished and placed as ordered, and the price herein stipulated (clause O, item (g.g.)) is to cover the cost of placing, driving, securing and fastening the same. No measurement of the tongues is to be made.

(48) **Crib-work.**—A large amount of crib-work is to be used in connection with the temporary Dams and at other points for the purpose of protecting the work from the water. The cribs will be generally placed in such a position, and constructed in such a manner, as indicated on the plans. They are to be built of tiers of logs or other sound timber acceptable to the Engineer, not more than four feet apart from centre to centre horizontally, and placed vertically above one another. At each point of contact the logs or timber are to be notched into one another and fastened with drift-bolts not less than five-eighths of an inch in diameter, of sufficient length to go through the entire thickness of two contiguous sticks, and into the third to a depth of not less than four inches. No log to be less than twelve inches in diameter at the

large end or less than nine inches at the smaller end. If other timber is used it must not be less than ten inches square in section. Whenever two cribs are placed side by side, as shown on the plans, every other cross log or timber is to extend continuously over the whole of the two cribs, for the purpose of strongly fastening them together. Particular attention must be given to the strength and frequency of this fastening of the two cribs at and near the points of meeting of the crib-work and of the temporary channel, especially on the down-stream side. At and near the ends of the lines of cribs, especially at their connections with the temporary channels, the logs or timbers must be closer to one another, and they must be so shaped and fastened as to make an exact connection.

The cribs are to be filled with stones of as large size as can be accommodated in the timber work, with as much smaller rock as will make a compact filling.

The price herein stipulated (clause O, item (*g g g.*)) per cubic yard of crib-work is to cover the cost of the crib-work complete, in place, including timber, drift-bolts, fastenings, stone filling, and all the materials and labor necessary to make the cribs and to place them in full working order. The work is to be measured to the outside lines of each crib, not including the space occupied by the filling of earth between the two cribs.

The space between the two cribs is to be filled with compact material, thoroughly rammed and watered whenever ordered.

Sheeting is to be placed on the various faces of the cribs, of such frequency and depth as, in the opinion of the Engineer, will be rendered necessary by the quality of the materials encountered. If the sheeting cannot be driven to the proper depth, it must be placed in trenches dug for the purpose. On the inside faces of the down-stream crib, especially, a line of deep sheeting shall be placed, to such a depth as the Engineer shall order.

All the excavation necessary for the placing of the cribs and sheeting, all the filling between them, and all the sheeting to be placed in connection therewith, are to be paid for as stipulated in clause O, items (*c.*), (*c c.*), (*d.*) and (*g.*) respectively.

A large amount of stone is to be dumped in front of and over the cribs, after they are completed, especially at their connection with the temporary channel; this work is to be paid for at the price stipulated in clause O, item (*d.*), as specified in clause (35).

#### MASONRY.

(49) **Hydraulic Masonry.**—All masonry, except where otherwise specified, shall be laid in hydraulic cement mortar, and shall be built of the forms and dimensions shown on the plans, or as directed by the Engineer from time to time, and the system of bonding ordered by the Engineer shall be strictly followed.

(50) All joints must be entirely filled with mortar, and the work in all cases shall be well and thoroughly bonded.

(51) Care must be taken that no water shall interfere with the proper laying of masonry in any of its parts.

(52) All means used to prevent water from interfering with the work, even to the extent of furnishing and placing pipes for conducting the water away from points where it might cause injury to the work, must be provided by the Contractor at his own expense.

(53) Under no circumstances will masonry be allowed to be laid in water.

(54) **Ironwork.**—All ironwork, except the gates, furnished by the City, is to be built in the masonry without other compensation than the price herein stipulated to be paid per cubic yard of masonry.

(55) No masonry is to be built between the 15th of November and the 15th of April, or in freezing weather, except by permission of the Engineer.

(56) All fresh masonry, if allowed to be built in freezing weather, must be covered and protected, and appliances must be procured for heating the water and sand used and for steaming the building materials, all in a manner satisfactory to the Engineer, and during hot weather, all newly built masonry shall be kept wet by sprinkling water on it until it shall have become hard enough to prevent its drying and cracking.

(57) **Cement.**—American cement and Portland cement are to be used. The American cement must be in good condition and must be equal in quality to the best Rosendale cement. It must be made by manufacturers of established reputation, must be fresh and very fine ground, and all cement must be delivered in well-made casks (or equally safe and tight receptacles approved by the Engineer). The Portland cement must be of a brand equal in quality to the best imported Portland cement. To insure its good quality, all the cement furnished by the Contractor will be subject to inspection and rigorous tests; and if found of improper quality, will be branded and must be immediately removed from the work; the character of the tests to be determined by the Engineer. The Contractor shall, at all times, keep in store at some convenient point in the vicinity of the work, a sufficient quantity of cement to allow ample time for the tests to be made without delay to the work of construction. The Engineer shall be notified at once of each delivery of cement. It shall be stored in a tight building, and each cask must be raised several inches above the ground, by blocking or otherwise.

(58) Cement is generally to be used in the form of mortar with an admixture of sand, and when so used, its cost is included in the price herein stipulated for the various kinds of masonry; for the foundation work, however, Portland cement may be ordered by the Engineer to be used without any admixture of sand in exceptionally wet and difficult places, for grouting seams or for such purposes as he may direct; such cement shall be furnished by the Contractor, and if it is used in connection with masonry, it will be paid for in addition to the price herein stipulated to be paid for said masonry. Such cement is to be paid for at so much per barrel of 400 lbs., furnished and delivered by the Contractor at the place where it must be used. See clause O, item (h.).

(59) **Mortar.**—All mortar shall be prepared from cement of the quality before described, and clean, sharp sand, free from loam. These ingredients shall be thoroughly mixed dry, as follows: The proportion of cement ordered, by measure, with the ordered proportion of sand, also by measure; and a moderate dose of water is to be afterwards

added to produce a paste of proper consistency; the whole to be thoroughly worked with hoes or other tools. In measuring cement, it shall be packed as received in casks from the manufacturer. The mortar shall be freshly mixed for the work in hand, in proper boxes made for the purpose; no mortar to be used that has become hard or set.

Portland cement is to be used clear for wet work and for pointing, as herein elsewhere specified.

It is also to be used in the proportion of one of cement to two of sand for laying the granite dimension stone, the facing stone, the block stone, masonry and the brick work.

For the rubble stone masonry and concrete masonry, American cement mortar is mostly to be used, and when Portland cement mortar is to be used instead, an additional price is to be paid, as follows:

When Portland cement mortar is to be used for rubble stone masonry and for concrete masonry in the proportion of one part of cement to two parts of sand, an additional price per cubic yard is to be paid to the Contractor, equal to thirty-two per cent. of the price herein stipulated per cubic yard for the said rubble masonry or concrete masonry, respectively (clause O, items (*k.*) and (*i.*))

When Portland cement mortar is to be used for rubble stone masonry in the proportion of one part of cement to three parts of sand, an additional price per cubic yard is to be paid to the Contractor equal to twenty-two per cent. of the price herein stipulated per cubic yard for the said rubble stone masonry (clause O, item (*k.*)).

(60) **Concrete.**—The concrete shall be formed of sound broken stone or gravel not exceeding two inches at their greatest diameter. All stone in any way larger is to be thrown out. The materials to be cleaned from dirt and dust before being used; to be mixed in proper boxes, with mortar of the quality before described, in the proportion of four parts of broken stone to one part of cement; to be laid immediately after mixing, and to be thoroughly compacted throughout the mass by ramming till the water flushes to the surface, the amount of water used for making the concrete to be approved or directed by the Engineer. The concrete shall be allowed to set for twelve hours, or more, if so directed, before any work shall be laid upon it; and no walking over or working upon it shall be allowed while it is setting.

(61) **Bricks.**—The bricks shall be of the best quality of hand-made, hard-burned bricks; burnt hard entirely through, regular and uniform in shape and size, and of compact texture. To insure their good quality, the bricks furnished by the Contractor will be subject to inspection and rigorous tests, and if found of improper quality, will be condemned; the character of the tests to be determined by the Engineer. They are to be culled before laying, at the expense of the Contractor; and all bricks of an improper quality shall be laid aside and removed; the Engineer to be furnished with men for this purpose by and at the expense of the Contractor.

(62) **Brick Masonry.**—All brick masonry shall be laid with bricks and mortar of the quality before described. No "bats" shall be used except in the backing, where a moderate proportion (to be determined by the Engineer) may be used, but nothing smaller than "half-bricks." The bricks to be thoroughly wet just before laying. Every

brick to be completely imbedded in mortar under its bottom and on its sides at one operation. Care shall be taken to have every joint full of mortar.

## STONE MASONRY.

(63) All stone masonry is to be built of sound, clean quarry stone of quality and size satisfactory to the Engineer; all joints to be full of mortar, unless otherwise specified.

(64) **Dry Rubble Stone Masonry and Paving.**—Dry rubble masonry and paving are to be laid without mortar, and are to be used for walls, for the slopes of the Dam embankments, and at any other place that may be designated.

(65) This class of masonry is to be of stone of suitable size and quality, laid closely by hand with as few spawls as practicable, in such manner as to present a smooth and true surface. The work is to be measured in accordance with the lines shown on the drawings or ordered during the progress of the work. The stones used must be roughly rectangular; all irregular projection and feather edges must be hammered off. No stone will be accepted which has less than the depth represented on the plans or ordered. Each stone used for paving must be set solid on the foundation of broken stone or earth and no interstices must be left.

(66) In the dry rubble masonry walls, large stones must be used, especially for the faces, and the walls must be bonded with frequent headers, of such frequency and sizes as shall be approved by the Engineer.

(67) **Rip-rap.**—Rip-rap may be used in connection with the protective work, and wherever the Engineer may order it. It shall be made of stone of such size and quality and in such manner as he shall direct, and must be laid by hand.

(68) **Broken Stones.**—After the slopes which are to receive the paving have been dressed, a layer of broken stone is to be spread as a foundation for the paving, wherever ordered. The broken stones must be sound and hard, not exceeding two inches at their greatest diameter. Broken stone, not exceeding one inch in diameter, may be used for forming roadways; it is to be spread to such thickness as ordered and heavily rolled or rammed. Broken stones may be used also wherever the Engineer may direct, rolled if so directed, and paid for under this head, except the broken stone used for making concrete, the cost of which is included in the price hereinbefore stipulated for concrete laid.

(69) **Rubble Stone Masonry.**—Rubble stone masonry is to be used for the central part of the Dam, for the overflow, for the centre walls of the earth embankments, for most of the structures and appurtenances of the Dam, and wherever ordered by the Engineer.

Rubble stone masonry shall be made of sound, clean stone of suitable size, quality and shape for the work in hand, and presenting good beds for materials of that class. Especial care must be taken to have the beds and joints full of mortar, and no grouting or filling of joints after the stones are in place will be allowed. The work must be thoroughly bonded. The faces of the rubble stone masonry, especially the up-stream face of the walls, shall be closely inspected after they are built, and if any mortar



joints are not full and flush, they shall be taken out to a depth of no less than three inches or more, if so ordered, and repointed properly.

(70) **Central Part of the Dam and Overflow.**—A large quantity of rubble stone masonry in mortar is to be used in the construction of the central part of the Dam and of the centre wall and overflow.

The stones used therein must be sound and durable; they must have roughly rectangular forms, and all irregular projections and feather edges must be hammered off. Their beds, especially, must be good for materials of that class, and present such even surfaces that, when lowering a stone on the level surface prepared to receive it, there can be no doubt that the mortar will fill all spaces. After the bed joints are thus secured, a moderate quantity of spawls can be used in the preparation of suitable surfaces for receiving other stones. All other joints must be equally well filled with mortar.

The quality of the beds is to regulate, to a large extent, the size of the stones used, as the difficulty of forming a good bed joint increases with the size of the stones.

Various sizes must be used, and regular coursing must be avoided, in order to obtain vertical as well as horizontal bonding.

(71) **Sizes.**—The sizes of the stones used will vary also with the character of the quarries, but, especially in the places where the thickness of masonry is great, a considerable proportion of large stones is to be used. If the size and character of the stones in the opinion of the Engineer shall admit of it, the joints (except the beds), instead of being filled with mortar, may, at his request or on his approval, be filled with concrete made as hereinbefore specified, with the exception that the component materials shall be mixed in the proportion of one part of cement to three parts of small stone or gravel of such size as the Engineer shall direct, and thoroughly rammed, care being taken to use a moderate amount of water only which must be brought to the surface by ramming, such filling of joints with concrete to leave no vacancies and to be thoroughly made. If concrete is so used, the spaces left between the stones should not be less than six inches, in order that proper ramming can be obtained.

No extra compensation shall be paid to the Contractor for the use of such concrete, the cost of which is to be included in the price herein stipulated for the masonry in connection with which it is used.

(72) **Face Work for Rubble Stone Masonry.**—The exposed faces of the main wing wall, of road culverts, of some of the walls and of any other rubble work that the Engineer may designate, are to be made of broken ashlar with joints not exceeding one-half inch in thickness; the stones not to be less than 24 inches deep from the face, and to present frequent headers. This face work to be equal in quality and appearance to the face of the breast wall in front of the new Gate House at Croton Dam, and to be well pointed with Portland cement. This face work is to be paid for by the square foot of the superficial area for which it is ordered, in addition to the price paid per cubic yard of rubble stone masonry.

(73) **Block Stone Masonry.**—Block stone masonry is to be composed mainly of large blocks and is to be used for the steps of the overfall or for other steps, or whenever and wherever ordered by the Engineer. It is to be laid in Portland cement

mortar, well pointed, or may be ordered laid dry at the price stipulated in clause O, item (o.).

This stone, which is to receive the shock of water and ice, is to be especially sound, hard and compact, and of a durable character; it is to be prepared to the dimensions given so that no joint will in any place be more than one inch wide. The outside arrises must be pitched to a true line.

(74) **Facing Stone Masonry.**—The outer faces of the Masonry Dam and of its gate chambers, of the overflow, (except steps,) and of any other piece of masonry that may be designated, are to be made of range stones, as shown on the plans, the stone to be of unobjectionable quality, sound and durable, free from all seams, discoloration and other defects, and of such kind as shall be approved by the Engineer.

(75) All beds, builds and joints are to be cut true to a depth of not more than 4 inches, and not less than 3 inches from the faces to surfaces, allowing of one-half inch joints at most; the joints for the remaining part of the stones not to exceed two inches in thickness at any point.

(76) All cut arrises to be true, well defined and sharp.

(77) Where this class of masonry joins with granite dimension stone masonry the courses must correspond, and the joining with arches and other dimension stone masonry must be accurate and workmanlike.

Each course to be composed of two stretchers and one header alternately, the stretchers not to be less than 3 feet long nor more than 7 feet long, and the headers of each successive course to alternate approximately in vertical position.

(78) The rise of the courses may vary from bottom to top from 30 inches to 15 inches in approximate vertical progression, and the width of bed of the stretchers is not to be at any point less than 28 inches. The headers are not to be less than 4 feet in length.

This class of masonry, for the faces of the Dam and gate chamber, including the headers, is to be estimated at 30 inches thick throughout. At other places that may be designated by the Engineer, the size of the stones is to be established by him, and the facing stone masonry is to be estimated according to the lines ordered or shown on the plans. In no case are the tails of the headers to be estimated.

The work to be equal in quality and appearance to the facing stone masonry work built by the Aqueduct Commissioners for the Masonry Dam across the East Branch of the Croton River near Brewster.

(79) All copings that may be ordered and the heads of the arches of the highway culverts, will be classed as facing stone masonry.

(80) The price herein stipulated for facing stone masonry is to cover the cost of pointing, of cutting chisel drafts at all corners of the Gate House Dam and other corners, and of preparing the rock faces; but if any six-cut or rough-pointed work is ordered in connection with this class of masonry it shall be paid for at the prices herein stipulated for such work. Clause O, items (s.) and (t.).

(81) The face bond must not show less than 12 inches lap, unless otherwise permitted.

(82) The pointing of the faces to be thoroughly made with pure Portland cement

after the whole structure is completed; unless otherwise permitted, every joint to be raked out therefor to a depth of at least two inches, and if the Engineer is satisfied that the pointing at any place is not properly made it must be taken out and made over again.

(83) **Granite Dimension Stone Masonry.**—Granite dimension stone masonry must be made of first-class granite of uniform color, free from all seams, discoloration and other defects, and satisfactory to the Chief Engineer.

(84) It is to be used for the gate openings in the gate chamber, for the coping of the Dam, for the Gate House superstructures and for the crest and first step of the overflow, and at any other place that may be designated by the Engineer.

(85) The stones shall be cut to exact dimensions, and all angles and arrises shall be true, well defined and sharp.

(86) All beds, builds and joints are to be dressed, for the full depth of the stone, to surfaces, allowing of one-quarter ( $\frac{1}{4}$ ) inch joint at most. No plug-hole of more than 6 inches across or nearer than 3 inches from an arris is to be allowed, and in no case must the aggregate area of the plug-hole in any one joint exceed one-quarter of its whole area.

(87) The stone shall be laid with one-quarter ( $\frac{1}{4}$ ) inch joints, and all face joints shall be pointed with mortar made of clear Portland cement, applied before its first setting. All joints to be raked out to a depth of two inches before pointing.

(88) **Pointing.**—The pointing of all masonry, including the faces of the main body of the Dam and of the centre walls which are below the ground, is to be done thoroughly with Portland cement mortar, mixed clear where used for all exposed faces of brick and cut stone masonry of all kinds (including the rubble facing); and mixed for other work in such proportion as the Engineer shall determine. The cost of all pointing is to be included in the price stipulated for the masonry to which it is applied.

(89) **Face Dressing.**—The exposed faces of the cut stone are to be finished in various ways, in accordance with the various positions in which they are placed. They shall be either left with a rock or quarry face, rough-pointed, or fine hammered (six-cut work).

(90) The various classes of face dressing must be equal in quality and appearance to those on the sample in the office of the Chief Engineer.

(91) **Rock Face Dressing.**—In rock face work the arrises of the stones inclosing the rock face must be pitched to true lines; the face projections to be bold, and from 3 to 5 inches beyond the arrises. The angles of all walls on structures having rock faces are to be defined by a chisel draft not less than  $1\frac{1}{2}$  inches wide on each face.

(92) **Rough-pointed Dressing.**—In rough-pointed work, the stones shall at all points be full to the true plane of the face, and at no point shall project beyond more than  $\frac{1}{4}$  inch, the arrises to be sharp and well defined. Each stone to have its arrises well defined by a chisel draft, which is included in the price for rough-pointed dressing.

(93) **Fine Hammered (six-cut) Dressing.**—In fine hammered work the face of the stones must be brought to a true plane and fine dressed, with a hammer having six blades to the inch.

(94) In measuring cut stone masonry, when the stones are not rectangular, the

dimensions taken for each stone will be those of a rectangular, cubical form which will just inclose the neat lines of the same. The price herein stipulated for granite dimension stone masonry is to cover the cost of preparing the rock faces, of making the chisel drafts, and of preparing all holes and recesses and grooves.

(95) No payment will be made for cutting grooves and recesses other than the price paid for the dressing of their surfaces, which are to be fine hammered.

(96) For rough-pointed and fine hammered (six-cut) dressing, a price per square foot of dressing will be paid in addition to the price per cubic yard of masonry, viz.:

(97) For rough-pointed dressing, the price stipulated in clause O, item (*t.*), and for fine hammered (six-cut) dressing, the price stipulated in clause O, item (*s.*).

(98) The exposed parts of the cut stone are generally to be prepared with rock face.

(99) The inside surfaces and copings are generally to be rough-pointed.

(100) All the gateways, grooves, sills, floors, and all other surfaces designated by the Engineer are to be fine hammered.

#### IRONWORK.

(101) All ironwork, such as spikes, bolts for fastening timber work, pipes, and all other ironwork used for temporary purposes, is to be furnished by the Contractor at his own expense.

All other ironwork which is to be used for permanent purposes, such as dowels for stonework, cast-iron pipes, beams, wall castings, ladders, and all other necessary ironwork which is to be built into the masonry, is to be furnished by the City and delivered in the vicinity of the work, but the Contractor is to haul them into place and to build them in the masonry at his own expense, including lead and other necessary materials, under the direction of the Engineer. Many parts of that ironwork are large and heavy and the placing of them will require considerable time and care.

When the Old Croton Aqueduct is discontinued for the purpose of connecting with the work of the Dam, a pipe is to be laid by the City for the purpose of uniting the two disconnected ends, and the Contractor is to do, at such time as the Engineer shall indicate, all necessary excavation and refilling necessary therefor, and to give the City all facilities for the work.

#### SUPERSTRUCTURE OF GATE HOUSES.

(102) The masonry part of the Superstructure of the Gate House is to be erected under this contract. The base, cornices, window and door trimmings are to be built of granite dimension stone masonry with such surface cutting as shall be ordered; the walls shall be built of the same stone, variously faced. The general appearance and style of the buildings will be similar to those of the new Gate House near the present Croton Dam; but through stones with two faces shall be used for the walls instead of brick and stone.

## FENCING.

(103) Fencing must be erected along the new highway wherever ordered; it is to be erected on the same plan as adopted by the City for the new highways built around the Brewsters Reservoir with the addition of one horizontal rail, and painted in the same manner.

## GENERAL CLAUSES.

(104) **Old Croton Aqueduct.**—The Contractor is to remove a portion of the Old Croton Aqueduct; as much of it and at such time as the Engineer shall designate, and the work of reconstruction of the same, in connection with the Dam, must proceed continuously and without delay. The Contractor must so arrange his work as not to interfere with the flow of water.

(105) **Fences.**—If found necessary, the Contractor shall erect and maintain, at his own expense, fences, for the protection of the adjoining property.

(106) **Cleaning and Finishing.**—At his own expense, and under the direction of the Engineer, the Contractor is to clear the work and the grounds occupied by him from all refuse and rubbish, and to leave them in neat condition.

(107) **Facilities.**—The Contractor is to give all facilities to the City for performing work which may be adjoining his own, or connected therewith.

(108) **Contractor not Present.**—Whenever the Contractor is not present on any part of the work where it may be necessary to give directions, orders will be given by the Engineer to, and shall be received and obeyed by, the superintendent or overseer of the Contractor who may have charge of the particular work in relation to which the orders are given.

(109) **Force to be Employed.**—The work shall be commenced and carried on in such order and at such times, points and seasons, and with such force as may, from time to time, be directed by the Engineer.

(110) **Lines and Grades.**—All lines and grades are to be given by the Engineer, who may change them from time to time as he may be authorized and directed by the said Aqueduct Commissioners.

(111) **Marks and Stakes.**—The stakes and marks given by the Engineer must be carefully preserved by the Contractor, who must give to the Engineer all necessary assistance and facilities for establishing the benches and plugs, and for making measurements.

(112) **Engineer to Explain Specifications.**—The plans and specifications are intended to be explanatory of each other, but should any discrepancy appear, or any misunderstanding arise as to the import of anything contained in either, the explanation of the Engineer shall be final and binding on the Contractor; and all directions and explanations required, alluded to, or necessary to complete any of the provisions of these specifications, and give them due effect, will be given by the Engineer.

(113) Any unfaithful or imperfect work that may be discovered before the final acceptance of the work shall be corrected immediately on the requirement of the

Engineer, notwithstanding that it may have been overlooked by the proper Inspector and estimated.

The inspection of the work shall not relieve the Contractor of any of his obligations to perform sound and reliable work, as herein described. And all work of whatever kind which, during its progress and before it is finally accepted, may become damaged for any cause, shall be broken up or removed, so much of it as may be objectionable, and replaced by good and sound work, satisfactory to the Engineer.

NOTE A.

(See page 37.)

*Maximum value for*

$$\frac{u}{x} = 1 - \frac{2(d^3 + b^3)}{3(d^3 + db^3)}, \dots \dots \dots (1)$$

in which  $d \geq b$ .

The maximum value will occur when  $\frac{d^3 + b^3}{d^3 + db^3}$  is a minimum.

Finding the First Differential Coefficient of this fraction, and placing it equal to 0, we obtain

$$\frac{2d^3 - 3d^2b - b^3}{(d^3 + db^3)^2} = 0. \dots \dots \dots (2)$$

The Second Differential Coefficient is obtained next, and found to be positive; hence any value for  $d$  which will satisfy Equation (2) will give a minimum value for the fraction, and consequently a maximum value for  $\frac{u}{x}$ .

Solving Equation (2) by Cardan's formula, we find

$$d = 1.677648b,$$

which is the depth corresponding to the maximum value of  $\frac{u}{x}$ .

Substituting this value of  $d$  in Equation (1), we find the maximum value of

$$\frac{u}{x} = 0.40392.$$

NOTE B.

(See page 38.)

*Minimum value for*

$$\frac{n}{x} = \frac{d^3 + 2b^3}{3(d^3 + db^3)}, \dots \dots \dots (1)$$

in which  $d \geq b$ .

Finding the First Differential Coefficient of this fraction, omitting the constant factor  $\frac{1}{3}$ , and placing it equal to 0, we obtain

$$\frac{d^3 - 3d^2b - b^3}{(d^3 + db^3)^2} = 0. \dots \dots \dots (2)$$

The Second Differential Coefficient is derived next, and found to be positive; hence any value for  $d$  which will satisfy Equation (2) will give a minimum value for the fraction  $\frac{n}{x}$ .

Solving Equation (2) by Cardan's formula, we find

$$d = 3.1038b,$$

which is the depth corresponding to a minimum value of  $\frac{n}{x}$ .

Substituting this value of  $d$  in Equation (1), we find the minimum value of

$$\frac{n}{x} = 0.32218.$$

#### NOTE C.

(See page 41.)

*The stability of Practical Profile No. 3 has been found graphically (see Plate XX.) by Mr. G. Bonanno, C.E. and Arch., who has also demonstrated that this profile presents at all depths a factor of safety of at least 2 against overturning. The following method was employed:*

**Reservoir Empty.**—Profile *MNQP* (Fig. 1) is divided into 10 courses, 1, 2, 3, . . . . . 10, by the horizontal joints *aa, bb, cc, . . . . . kk*. The centres of gravity,  $g_1, g_2, g_3, \dots, g_{10}$ , of courses 1 to 10 are found in the usual manner, the vertical section of each course being assumed to form a trapezoid or rectangle. The centres of gravity,  $g_1, g_2, g_3, \dots, g_{10}$ , and the centre points of the joints *aa, bb, cc, . . . . . kk*, are connected by a line which will be the *medial line* of the profile *MNQP*.

Find next for each joint, *aa, bb, cc, . . . . . kk*, the resultant of the forces acting in the wall above it. The points where these resultants intersect their respective joints will lie in the *line of pressure*. When the reservoir is empty, the only forces acting on the wall are the weights of the different courses 1 to 10, each being applied at the centre of gravity of the respective course. Through  $g_1, g_2, g_3, \dots, g_{10}$ , draw the vertical lines 1-1, 2-2, 3-3, . . . . . 10-10 (Fig. 3). On the vertical line *OZ* (Fig. 2) of the force polygon draw to any convenient scale  $Ow_1, Ow_2, Ow_3, \dots, Ow_{10}$ , equal to the weights above the joints *aa, bb, cc, . . . . . kk*, respectively. Assuming any point *P* as a pole in the force polygon (Fig. 2), we can obtain the corresponding funicular polygon (Fig. 3) which gives for each joint the position of the resultant of the weights resting on it. Thus for the joint *hh* the value of the resultant is given by  $OW_8$  (Fig. 2), and its position is determined by the point  $S_8$ , where the lines drawn parallel to *PO* and  $PW_8$  in the funicular polygon (Fig. 3) intersect. The point  $S_8'$  (Fig. 1) at which a vertical line ( $W_8$ ) passing through  $S_8$  intersects the joint *hh* is one point in the *line of pressure, reservoir empty*. In a similar manner the points where this line intersects the other joints were found.

**Reservoir Full.**—The position of the *line of pressure, reservoir full*, can be determined as follows:

Lay off in the force polygon on the horizontal line *OH* the distances  $Ot_1, Ot_2, Ot_3, \dots, Ot_{10}$ , which represent the horizontal thrusts of the water for the joints *aa, bb, cc, . . . . . kk*, respectively. (The vertical component of the water-pressure is neglected as in the Analytical Method given in Chapter III.) The lines  $w_1t_1, w_2t_2, w_3t_3, \dots, w_{10}t_{10}$  will represent the resultants acting on the joints *aa, bb, cc, . . . . . kk* when the reservoir is full. To find the points where these resultants are applied to their respective joints, draw horizontal lines through the points  $r_1, r_2, r_3, \dots, r_{10}$ , through which pass the resultant water-pressures



for the vertical depths:  $Na, Nb, Nc, \dots, NQ$ . The points  $r_1, r_2, r_3, \dots, r_{10}$  are at  $\frac{1}{3}$  of the vertical depths of their respective joints below the top of the dam.

The horizontal lines through  $r_1, r_2, r_3, \dots, r_{10}$  are produced until they intersect the vertical lines  $W_1, W_2, W_3, \dots, W_{10}$ , which represent the resultant pressures of the weights of the courses on the joints  $aa, bb, cc, \dots, kk$ . From the intersection points found thus draw the lines  $R_1, R_2, R_3, \dots, R_{10}$  parallel to  $t_1w_1, t_2w_2, t_3w_3, \dots, t_{10}w_{10}$ , and produce them until they intersect the corresponding joints  $aa, bb, cc, \dots, kk$ . For instance, the thrust of the water above the joint  $hh$  passes through  $r_8$ , through which a horizontal line is produced until it meets the vertical line  $W_8$  in  $V$ . From this point draw a line parallel to  $t_8w_8$  (Fig. 2). The point  $V'$  at which it intersects the joint  $hh$  is a point in the *line of pressure, reservoir full*. In a similar manner the points where this line crosses the other joints may be found.

**Factor of Safety against Overturning.**—To test whether the profile  $MNQP$  has at all depths a factor of safety of 2 against overturning, imagine the reservoir to be filled with a liquid having double the density of water and exerting, therefore, twice the horizontal pressure of water. The line of pressure for this assumed liquid is found in precisely the same manner as for water. In the force polygon (Fig. 2) lay out the new horizontal pressures in the line  $OH$ . Draw dotted lines (see Fig. 2) from the points  $w_1, w_2, w_3, \dots, w_{10}$  to the corresponding points in the line  $OH$ . The dotted lines will represent the new resultants. From the points where the horizontal lines through  $r_1, r_2, r_3, \dots, r_{10}$  meet the vertical lines  $W_1, W_2, W_3, \dots, W_{10}$  (Fig. 1) draw lines respectively parallel to the dotted lines (Fig. 2). The points where these lines intersect the corresponding joints  $aa, bb, cc, \dots, kk$  are points on the line of pressure for a liquid having a specific gravity of 2. The fact that this line lies entirely within the profile  $MNQP$  proves that this profile will ensure at all depths a factor of safety of 2 against overturning.

The resistance which this profile offers against sliding or shearing is found by measuring the angles which the resultants (reservoir full) make with vertical lines. Thus for the joint  $hh$  the angle to be measured is that between  $R_8$  and  $W_8$ . So long as the tangent of these angles is less than 0.75 (see page 15), the dam will have ample strength at the corresponding joints against sliding.

The maxima pressures at any joint can be found by measuring the distances between the line of pressures, reservoir full and empty, with the front and back face respectively, which distances must be substituted in formula (A) or (B) (page 14).

---

### TABLES.

The following Tables, which have been referred to in the previous pages, serve to illustrate our text by giving: (1) The dimensions and strength of the profile-types designed by eminent engineers; (2) Proofs of the principles discussed in this book; (3) Practical examples of the method we have proposed for designing profiles.—The peculiar top width (18.74 feet) adopted for some of our profiles is that assumed by Prof. Rankine for his Logarithmic Type (see Table III.), and was used by us for comparison. Table XXIV. facilitates the reduction of metres into feet, and gives the English equivalent of the metric square and cubic measures.

TABLE I.\*

(See page 2.)

## M. DE SAZILLY'S PROFILE-TYPE.

Depth of Water, in Metres.	Horizontal Thrusts, in Tons of 2205 lbs.	Total Vertical Pressures, in Tons of 2205 lbs.	Area, in Square Metres.	DISTANCE TO LINE OF PRESSURE.		MAXIMUM PRESSURE TO THE SQUARE CENTIMETRE.		Coefficient of Friction necessary for Equilibrium.
				From Front Face, Reservoir Full.	From Back Face, Reservoir Empty.	Reservoir Full.	Reservoir Empty.	
9	40.50	90.00	45.00	1.15	2.50	5.22	1.80	0.450
11	60.50	113.20	56.60	1.25	2.58	6.00	2.60	0.534
13	84.50	140.88	70.44	1.50	2.75	6.00	3.28	0.599
15	112.50	173.56	86.78	1.92	3.00	6.01	3.81	0.648
17	144.50	211.72	105.86	2.35	3.32	6.02	4.24	0.682
19	180.50	255.76	127.88	2.84	3.70	6.00	4.61	0.705
21	220.50	306.04	153.02	3.40	4.12	6.00	4.95	0.720
23	264.50	362.88	180.44	4.03	4.59	6.00	5.27	0.729
25	312.50	426.64	213.32	4.74	5.09	6.00	5.58	0.732
27	364.50	497.68	248.84	5.53	5.63	6.00	5.89	0.732
29	420.50	579.98	288.44	6.47	6.42	6.00	5.99	0.725
31	480.50	674.23	332.52	7.57	7.39	6.01	6.00	0.713
33	544.50	780.25	381.42	8.81	8.47	6.00	6.00	0.698
35	612.50	898.69	435.36	10.13	9.65	6.00	5.98	0.682
37	684.50	1030.33	494.62	11.56	10.93	6.00	5.96	0.664
39	760.50	1174.10	559.38	13.06	12.22	5.98	5.99	0.648
41	840.50	1333.24	629.98	14.67	13.65	5.98	6.00	0.630
43	924.50	1507.79	706.70	16.38	15.16	5.97	6.00	0.613
45	1012.50	1698.58	789.84	18.20	16.77	5.98	6.00	0.596
47	1104.50	1906.43	879.70	20.11	18.48	5.98	6.00	0.579
49	1200.50	2132.19	976.60	22.12	20.27	5.98	6.00	0.563
51	1300.50	2377.29	1080.00	24.27	22.18	6.00	6.00	0.547

Specific Gravity of the Masonry = 2.

1 Ton = 1 cubic metre of water = 2204.737 lbs.

\* From M. Delocre's memoir in the "Annales des Ponts et Chaussées," 1866.

TABLE II.\*

(See page 3.)

## M. DELOCRE'S PROFILE-TYPE.

Depth of Water, in Metres.	Horizontal Thrusts, in Tons of 2205 lbs.	Total Vertical Pressures, in Tons of 2205 lbs.	Area, in Square Metres.	DISTANCE TO LINE OF PRESSURE.		MAXIMUM PRESSURE TO THE SQUARE CENTIMETRE.		Coefficient of Friction necessary for Equilibrium.
				From Front Face, Reservoir Full.	From Back Face, Reservoir Empty.	Reservoir Full.	Reservoir Empty.	
2	2.00	20.51	10.253	2.62	2.56	0.39	0.27	0.095
4	8.00	42.02	21.012	2.59	2.65	0.92	0.85	0.190
6	18.00	64.56	32.278	2.50	2.69	1.57	1.34	0.275
8	32.00	88.10	44.052	2.28	2.76	2.52	1.84	0.360
10	50.00	112.66	56.330	1.94	2.82	3.86	2.34	0.440
12	72.00	138.24	69.120	1.54	2.89	5.98	2.83	0.520
14	98.00	167.22	83.608	2.21	3.02	5.05	3.65	0.585
16	128.00	201.99	100.993	2.78	3.25	4.84	4.16	0.630
18	162.00	242.55	121.275	3.30	3.56	4.90	4.54	0.665
20	200.00	288.91	144.454	3.78	3.92	5.10	4.92	0.690
22	242.00	341.06	170.530	4.24	4.32	5.36	5.27	0.705
24	288.00	399.01	199.503	4.69	4.74	5.67	5.61	0.720
26	338.00	462.76	231.380	5.14	5.19	6.00	5.95	0.730
28	392.00	548.85	267.020	6.31	6.16	5.79	5.79	0.714
30	450.00	645.24	307.312	7.43	7.21	5.81	5.68	0.697
32	512.00	761.80	357.247	8.57	8.23	5.85	5.73	0.672
34	578.00	869.12	401.828	9.76	9.26	5.89	5.76	0.665
36	648.00	996.65	456.055	10.83	10.28	5.99	5.87	0.640
38	722.00	1134.59	514.940	12.12	11.30	6.00	6.00	0.636
40	800.00	1307.07	579.283	13.89	12.90	5.96	5.90	0.612
42	882.00	1494.37	649.912	15.69	14.48	5.91	5.85	0.589
44	968.00	1696.50	726.830	17.46	16.04	5.93	5.81	0.570
46	1058.00	1913.41	810.020	19.17	17.60	5.94	5.85	0.552
48	1152.00	2145.19	899.515	21.00	19.14	5.93	5.98	0.537
50	1250.00	2391.78	995.300	22.76	20.67	6.00	6.00	0.522

Specific Gravity of the Masonry = 2.

1 Ton = 1 cubic metre of water = 2204.737 lbs.

\* From M. Delocre's memoir in the "Annales des Ponts et Chaussées," 1866.

TABLE III.

(See page 32.)

PROF. RANKINE'S PROFILE-TYPE.

Depth of Water Below Top of Dam in Feet.	Horizontal Thrust of Water, in Cubic Feet of Masonry.	Moment of Water, in Cubic Feet of Masonry.	JOINT REFERRED TO A VERTICAL AXIS.			Total Area, in Square Feet.	Distance from Front Face to Line of Pressure, Reservoir Full, in Feet.	Distance from Back Face to Line of Pressure, Reservoir Empty, in Feet.	MAXIMA PRESSURES.				Coefficient of Friction necessary for Equilibrium.	Factor of Safety against Overturning.
			Left, in Feet.	Right, in Feet.	Total, in Feet.				Reservoir Full.		Reservoir Empty.			
									In Feet of Masonry.	In Tons of 2000 lbs.	In Feet of Masonry.	In Tons of 2000 lbs.		
0	0	0	17.40	1.34	18.74	0	9.37	9.37	0.0	0.00	0.0	0.00	0.00	0.0
10	25	83	19.72	1.52	21.24	200	10.73	10.09	9.1	0.57	10.8	0.68	0.13	26.7
20	100	667	22.35	1.72	24.07	426	11.62	10.89	19.6	1.23	22.8	1.43	0.23	8.5
30	225	2250	25.29	1.94	27.23	679	12.13	11.79	33.1	2.07	34.9	2.18	0.33	4.7
40	400	5333	28.69	2.21	30.90	973	12.57	12.85	49.1	3.07	47.4	2.96	0.41	3.3
50	625	10417	32.53	2.50	35.03	1303	13.01	14.02	65.9	4.12	59.5	3.72	0.48	2.6
60	900	18000	36.83	2.83	39.66	1674	13.56	15.35	82.2	5.14	70.8	4.43	0.54	2.3
70	1225	28583	41.75	3.21	44.96	2098	14.48	16.86	96.6	6.01	81.7	5.11	0.58	2.1
80	1600	42667	47.31	3.64	50.95	2577	15.83	18.57	108.5	6.78	91.7	5.73	0.62	2.0
90	2025	60750	53.61	4.12	57.73	3119	17.74	20.51	117.2	7.33	100.9	6.31	0.65	1.9
100	2500	83333	60.75	4.67	65.42	3734	20.39	22.71	122.1	7.63	109.5	6.84	0.67	1.9
110	3025	110917	68.84	5.29	74.13	4431	23.91	25.19	123.6	7.73	117.3	7.33	0.68	2.0
120	3600	144000	78.00	6.00	84.00	5221	28.40	28.02	122.6	7.66	124.3	7.77	0.69	2.0
130	4225	183083	88.39	6.80	95.19	6116	34.05	31.21	119.1	7.44	130.6	8.16	0.69	2.1
140	4900	228667	100.15	7.70	107.85	7129	40.95	34.83	113.8	7.11	136.5	8.53	0.69	2.3
150	5625	281250	113.49	8.73	122.22	8278	49.31	38.94	107.0	6.69	141.7	8.87	0.68	2.5
160	6400	341333	128.60	9.90	138.50	9581	59.29	43.59	99.1	6.19	146.5	9.16	0.67	2.7
170	7225	409417	145.72	11.21	156.93	11055	71.05	48.85	90.3	5.64	150.9	9.43	0.65	2.9
180	8100	486000	165.14	12.70	177.84	12728	84.83	54.82	81.4	5.09	154.8	9.68	0.64	3.2
190	9025	571583	187.10	14.40	201.50	14621	100.82	61.59	72.6	4.54	158.3	9.89	0.62	3.6
200	10000	666667	212.00	16.30	228.30	16765	119.30	69.24	63.6	3.98	161.4	10.09	0.60	4.0

The Specific Gravity of the Masonry = 2.

TABLE IV.

(See page 32.)

THEORETICAL PROFILE.

BASED ON PROFESSOR RANKINE'S LIMITS AND CONDITIONS.

Depth of Water Below Top of Dam in Feet.	Horizontal Thrust of Water, in Cubic Feet of Masonry.	Moment of Water, in Cubic Feet of Masonry.	JOINT REFERRED TO A VERTICAL AXIS.			Total Area, in Square Feet.	Distance from Front Face to Line of Pressure, Reservoir Full, in Feet.	Distance from Back Face to Line of Pressure, Reservoir Empty, in Feet.	MAXIMA PRESSURES.				Coefficient of Friction necessary for Equilibrium.	Factor of Safety against Overturning.
			Left, in Feet.	Right, in Feet.	Total, in Feet.				Reservoir Full.		Reservoir Empty.			
									In Feet of Masonry.	In Tons of 2000 lbs.	In Feet of Masonry.	In Tons of 2000 lbs.		
0.0	0	0	18.74	0.00	18.74	0	9.37	9.37	0.0	0.00	0.0	0.00	0.00	0.0
26.5	175	1551	18.74	0.00	18.74	497	6.25	9.37	53.0	3.31	26.5	1.66	0.35	3.0
40.0	400	5333	25.08	0.00	25.08	792	8.36	9.90	63.1	3.94	50.8	3.18	0.51	2.2
50.0	625	10417	31.17	0.00	31.17	1074	10.39	11.08	68.9	4.31	64.4	4.03	0.58	2.1
60.0	900	18000	37.92	0.00	37.92	1419	12.64	12.60	74.8	4.68	75.1	4.69	0.63	2.0
70.0	1225	28583	45.52	1.04	46.56	1842	15.52	15.52	79.1	4.94	79.1	4.94	0.66	2.0
80.0	1600	42667	52.83	1.64	54.47	2347	18.16	18.16	86.2	5.39	86.2	5.39	0.68	2.0
90.0	2025	60750	60.16	2.04	62.20	2930	20.73	20.73	94.2	5.89	94.2	5.89	0.69	2.0
100.0	2500	83333	67.16	2.29	69.65	3589	23.22	23.22	103.1	6.44	103.1	6.44	0.69	2.0
110.0	3025	110917	74.52	2.46	76.98	4322	25.66	25.66	112.3	7.02	112.3	7.02	0.70	2.0
120.0	3600	144000	81.65	2.58	84.23	5129	28.08	28.08	121.8	7.61	121.8	7.61	0.70	2.0
130.0	4225	183083	90.36	3.38	93.74	6018	32.07	31.25	125.0	7.81	128.4	8.03	0.70	2.1
140.0	4900	228667	100.24	4.53	104.77	7011	37.23	34.92	125.0	7.81	133.8	8.36	0.70	2.1
150.0	5625	281250	110.55	5.64	116.19	8116	42.81	38.73	125.0	7.81	139.7	8.73	0.69	2.2
160.0	6400	341333	121.28	6.72	128.00	9337	48.78	42.66	125.0	7.81	145.9	9.12	0.69	2.3
170.0	7225	409417	132.40	7.78	140.18	10678	55.12	46.72	125.0	7.81	152.3	9.52	0.68	2.4
180.0	8100	486000	143.91	8.82	152.73	12142	61.80	50.90	125.0	7.81	159.0	9.94	0.67	2.5
190.0	9025	571583	156.16	11.91	168.07	13746	69.25	57.23	125.0	7.81	160.0	10.00	0.66	2.6
200.0	10000	666667	168.93	15.86	184.79	15510	77.32	64.49	125.0	7.81	160.0	10.00	0.65	2.8

The Specific Gravity of the Masonry = 2.

TABLE V.

(See page 6.)

## M. KRANTZ'S PROFILE-TYPE.

Depth of Water, in Metres.	Vertical Water-pressure, in Cubic Metres of Masonry.	Horizontal Thrust of Water, in Cubic Metres of Masonry.	Moment of Water, in Cubic Metres of Masonry.	JOINT REFERRED TO A VERTICAL AXIS.			Total Area, in Square Metres.	Distance from Front Face to Line of Pressure, Reservoir Full, in Metres.	Distance from Back Face to Line of Pressure, Reservoir Empty, in Metres.	MAXIMA PRESSURES.				Coefficient of Friction necessary for Equilibrium.	Factor of Safety against Overturning.
				Left of Axis, in Metres.	Right of Axis, in Metres.	Total, in Metres.				Reservoir Full.		Reservoir Empty.			
										In Metres of Masonry.	In Kilos per Sq. Cent.	In Metres of Masonry.	In Kilos per Sq. Cent.		
0	0.00	0.00	0.00	5.00	0.00	5.00	17.50	2.50	2.50	7.00	1.61	7.00	1.61	0.00	0.0
5	0.20	5.43	9.06	5.29	0.14	5.43	43.21	2.60	2.64	8.95	2.06	8.59	1.98	0.12	13.4
10	1.59	21.74	72.46	6.16	0.55	6.71	73.19	2.67	3.13	18.05	4.15	13.09	3.01	0.29	3.8
15	5.41	48.91	244.57	7.65	1.24	8.89	111.74	3.00	3.98	26.09	6.00	16.59	3.82	0.42	2.4
20	12.95	86.96	579.71	9.84	2.23	12.07	163.83	3.90	5.21	30.22	6.95	19.00	4.37	0.49	2.2
25	25.46	135.87	1132.24	12.85	3.50	16.35	234.33	5.65	6.87	30.51	7.02	21.21	4.88	0.52	2.3
30	44.51	195.65	1956.52	16.91	5.09	22.00	329.60	8.60	9.00	28.23	6.49	23.07	5.31	0.52	2.6
35	71.57	266.30	3106.89	22.50	7.00	29.50	457.31	13.13	11.71	24.03	5.53	25.11	5.78	0.50	3.2
40	141.10	347.83	4637.69	28.50	11.33	39.83	635.61	19.09	17.01	21.84	5.02	22.98	5.29	0.45	4.2
45	202.73	440.22	6603.26	33.50	14.67	48.17	855.61	23.62	21.21	23.29	5.35	24.15	5.55	0.41	4.8
50	271.58	543.48	9059.97	38.50	18.00	56.50	1117.31	28.16	25.31	25.07	5.77	26.10	6.00	0.39	5.3

The Specific Gravity of the Masonry = 2.3.

TABLE VI.

(See page 6.)

## PROF. A. R. HARLACHER'S PROFILE-TYPE.

Position of Horizontal Joint Below Top of Dam, in Metres.	Depth of Water, in Metres.	Horizontal Component of Water-Pressure, in Tons of 1000 Kilos.	Vertical Component of Water-Pressure, in Tons of 1000 Kilos.	JOINT REFERRED TO VERTICAL AXIS.			Total Area of Profile, in Square Metres.	Total Weight of Masonry, in Tons of 1000 Kilos.	Distance from Front Face to Line of Pressure, Reservoir Full, in Metres.	Distance from Back Face to Line of Pressure, Reservoir Empty, in Metres.	MAXIMA PRESSURES.		Coefficient of Friction necessary for Equilibrium.	Factor of Safety against Overturning.
				Left of Axis, in Metres.	Right of Axis, in Metres.	Total, in Metres.					Reservoir Full.	Reservoir Empty.		
											In Kilos per Sq. Cent.	In Kilos per Sq. Cent.		
0.00	0.00	0.0	0.0	4.00	0.00	4.00	0.00	0.0	2.00	2.00	0.00	0.00	0.00	0.0
2.50	0.00	0.0	0.0	4.00	0.00	4.00	10.00	22.0	2.00	2.00	0.55	0.55	0.00	0.0
5.00	2.50	3.1	0.0	4.00	0.00	4.00	20.00	44.0	1.94	2.00	1.12	1.10	0.07	33.3
7.50	5.00	12.5	0.0	4.20	0.00	4.20	30.20	66.4	1.87	2.10	2.10	1.58	0.19	6.9
10.00	7.50	28.1	0.0	4.75	0.00	4.75	41.35	90.9	1.87	2.17	3.11	2.55	0.31	3.4
12.50	10.00	50.0	0.0	5.65	0.00	5.65	54.35	119.5	2.02	2.22	3.90	3.43	0.42	2.4
15.00	12.50	78.1	0.0	7.05	0.00	7.05	70.15	154.3	2.47	2.47	4.13	4.16	0.51	2.2
17.50	15.00	112.5	0.7	8.75	0.00	8.75	89.85	197.6	3.17	2.77	4.13	4.75	0.57	2.1
20.00	17.50	153.1	3.0	10.45	0.15	10.60	114.05	250.8	3.80	3.35	4.42	5.00	0.60	2.1
22.50	20.00	200.0	7.6	12.12	0.40	12.52	142.95	314.4	4.36	4.06	4.91	5.16	0.62	2.1
25.00	22.50	253.1	14.8	13.80	0.75	14.55	176.75	388.8	5.13	4.88	5.24	5.34	0.63	2.1
27.50	25.00	312.5	25.2	15.50	1.20	16.70	215.75	474.6	5.90	5.85	5.64	5.40	0.62	2.1
30.00	27.50	378.1	39.5	17.19	1.70	18.89	260.25	572.7	6.79	6.84	6.00	5.53	0.62	2.2
32.50	30.00	450.0	53.3	18.88	2.35	21.23	310.40	683.0	7.77	7.92	6.28	5.67	0.61	2.3
35.00	32.50	528.1	81.8	20.57	3.10	23.67	366.52	806.5	8.93	9.13	6.49	5.74	0.60	2.4
37.50	35.00	612.5	111.2	22.26	4.00	26.26	428.92	943.8	10.13	10.48	6.73	5.75	0.59	2.5

The Specific Gravity of the Masonry = 2.2.

TABLE VII.

(See page 6.)

M. CRUGNOLA'S PROFILE-TYPE.

Depth of Water, in Metres.	Length of Joint, in Metres.	Weight per Lineal Metre, in Tons of 2205 lbs.*	Distance of the Line of Pressure from the Centre of the Joint.		Maxima Pressures per Square Centimetre.		Vertical Component	Horizontal Component	Coefficient of Friction necessary for Equilibrium.
			Reservoir Full, in Metres.	Reservoir Empty, in Metres.	At Front Face, in Kilos.	At Back Face, in Kilos.			
10	6.00	155.82	0.00	0.00	0.000	0.000	155.8	50.0	0.321
15	8.58	239.66	1.00	1.25	5.832	5.232	239.6	112.5	0.469
20	12.52	360.98	1.47	2.20	6.482	5.922	364.4	200.0	0.549
25	16.72	529.11	1.85	2.91	7.186	6.468	543.1	312.5	0.575
30	21.20	747.15	2.05	3.42	7.821	6.936	781.1	450.0	0.576
35	26.96	1018.32	1.95	4.20	7.601	7.309	1083.3	612.5	0.565
40	33.28	1364.70	1.70	4.80	7.480	7.648	1476.7	800.0	0.542
45	39.93	1785.66	1.50	5.20	7.664	7.965	1968.1	1012.5	0.514
50	46.92	2285.05	1.10	5.45	7.721	8.265	2565.0	1250.0	0.487

\* 1 Ton = 1 cubic metre of water = 2204.737 lbs. The Specific Gravity of the Masonry = 2.3.

TABLE VIII.

(See page 28.)

THEORETICAL PROFILE No. 1.

Depth of Water Below Top of Dam, in Feet.	Horizontal Thrust of Water, in Cubic Feet of Masonry	Moment of Water, in Cubic Feet of Masonry.	JOINT REFERRED TO A VERTICAL AXIS.			Total Area, in Square Feet.	Distance from Front Face to Line of Pressure, Reservoir Full, in Feet.	Distance from Back Face to Line of Pressure, Reservoir Empty, in Feet.	MAXIMA PRESSURES.				Coefficient of Friction necessary for Equilibrium	Factor of Safety against Overturning.
			Left, in Feet.	Right, in Feet.	Total, in Feet.				Reservoir Full.		Reservoir Empty.			
									In Feet of Masonry.	In Tons of 2000 lbs.	In Feet of Masonry.	In Tons of 2000 lbs.		
0.0	0	0	18.74	0.00	18.74*	0.0	9.37	0.0	0.00	0.0	0.00	0.00	0.0	0.0
37.1	295	3648	18.74	0.00	18.74	695.3	4.12	9.37	112.3	8.19†	37.1	2.71	0.42	1.8
50.0	535	8929	24.76	0.00	24.76	975.8	5.79	9.82	112.3	8.19	63.9	4.66	0.55	1.6
60.0	771	15429	30.47	0.00	30.47	1252.0	7.44	10.71	112.3	8.19	78.1	5.69	0.62	1.6
70.0	1049	24500	36.87	0.00	36.87	1588.7	9.43	12.02	112.3	8.19	88.1	6.42	0.66	1.6
80.0	1370	36571	43.87	0.00	43.87	1992.4	11.84	13.68	112.3	8.19	97.2	7.09	0.68	1.6
90.0	1734	52071	51.39	0.00	51.39	2468.7	14.65	15.65	112.3	8.19	105.0	7.66	0.70	1.7
100.0	2141	71429	59.44	0.00	59.44	3022.8	17.94	17.85	112.3	8.19	112.8	8.22	0.71	1.8
110.0	2591	95071	68.02	0.00	68.02	3660.1	21.73	20.32	112.3	8.19	122.2	8.91	0.71	1.8
120.0	3084	123429	77.15	0.00	77.15	4386.0	26.04	22.97	112.3	8.19	127.3	9.28	0.70	1.9
130.0	3619	156929	86.73	0.00	86.73	5205.4	30.77	25.81	112.3	8.19	134.4	9.80	0.69	2.0
140.0	4197	196000	96.72	0.00	96.72	6122.6	35.89	28.82	112.3	8.19	140.4	10.24‡	0.68	2.1
150.0	4818	241071	107.25	2.02	109.27	7152.6	41.61	33.96	112.3	8.19	140.4	10.24	0.67	2.2
160.0	5482	292571	118.21	4.34	122.55	8311.7	47.88	39.47	112.3	8.19	140.4	10.24	0.66	2.4

\* The top width was made equal to that of Rankine's Type (see Table III.), for comparison.

† Equivalent to 8 kilos. per square centimetre.

‡ Equivalent to 10 kilos. per square centimetre.

The Specific Gravity of the Masonry = 2½.

## APPENDIX

TABLE IX.

(See page 28.)

## THEORETICAL PROFILE No. 2.

Depth of Water Below Top of Dam, in Feet.	Horizontal Thrust of Water, in Cubic Feet of Masonry.	Moment of Water, in Cubic Feet of Masonry.	JOINT REFERRED TO A VERTICAL AXIS.			Total Area, in Square Feet.	Distance from Front Face to Line of Pressure, Reservoir Full, in Feet.	Distance from Back Face to Line of Pressure, Reservoir Empty, in Feet.	MAXIMA PRESSURES.				Coefficient of Friction necessary for Equilibrium.	Factor of Safety against Overturning.
			Left, in Feet.	Right, in Feet.	Total, in Feet.				Reservoir Full.		Reservoir Empty.			
									In Feet of Masonry.	In Tons of 2000 lbs.	In Feet of Masonry.	In Tons of 2000 lbs.		
0.00	0	0	16.40	0.00	16.40*	0.0	8.20	8.20	0.00	0.00	0.0	0.00	0.00	0.00
37.47	301	3758	16.40	0.00	16.40	614.5	2.09	8.20	196.53	14.34†	37.5	2.73	0.49	1.34
50.00	535	8929	21.95	0.00	21.95	854.8	2.90	8.61	196.53	14.34	64.1	4.67	0.63	1.28
60.00	771	15429	27.19	0.00	27.19	1100.5	3.73	9.44	196.53	14.34	77.7	5.67	0.70	1.26
70.00	1049	24500	32.89	0.00	32.89	1400.9	4.74	10.65	196.53	14.34	87.2	6.36	0.75	1.27
80.00	1370	36571	38.90	0.00	38.90	1759.8	5.98	12.14	196.53	14.34	96.7	7.05	0.78	1.29
90.00	1734	52071	45.14	0.00	45.14	2180.0	7.39	13.86	196.53	14.34	104.9	7.65	0.79	1.31
100.00	2141	71429	51.59	0.00	51.59	2663.7	9.03	15.74	196.53	14.34	112.9	8.23	0.80	1.33
110.00	2591	95071	58.24	0.00	58.24	3212.8	10.90	17.75	196.53	14.34	120.7	8.80	0.80	1.37
120.00	3084	123429	65.10	0.00	65.10	3829.5	13.04	19.84	196.53	14.34	128.7	9.38	0.80	1.41
130.00	3619	156929	72.11	0.00	72.11	4515.6	15.32	22.04	196.53	14.34	136.6	9.96	0.80	1.44
140.00	4197	196000	79.37	0.00	79.37	5273.0	17.88	24.32	196.53	14.34	144.5	10.54	0.80	1.48
150.00	4818	241071	86.87	0.00	86.87	6104.2	20.71	26.67	196.53	14.34	152.6	11.13	0.79	1.53
160.00	5482	292571	94.61	0.00	94.61	7011.6	23.78	29.10	196.53	14.34	160.6	11.71	0.78	1.57

\* Equal to 5 metres.

† Equivalent to 14 kilos. per square centimetre.

The Specific Gravity of the Masonry = 2½.

TABLE X.

(See page 29.)

## THEORETICAL PROFILE No. 3.

Depth of Water Below Top of Dam, in Feet.	Horizontal Thrust of Water, in Cubic Feet of Masonry.	Moment of Water, in Cubic Feet of Masonry.	JOINT REFERRED TO A VERTICAL AXIS.			Total Area, in Square Feet.	Distance from Front Face to Line of Pressure, Reservoir Full, in Feet.	Distance from Back Face to Line of Pressure, Reservoir Empty, in Feet.	MAXIMA PRESSURES.				Coefficient of Friction necessary for Equilibrium.	Factor of Safety against Overturning.
			Left, in Feet.	Right, in Feet.	Total, in Feet.				Reservoir Full.		Reservoir Empty.			
									In Feet of Masonry.	In Tons of 2000 lbs.	In Feet of Masonry.	In Tons of 2000 lbs.		
0.0	0	0	18.74	0.00	18.74*	0	9.37	9.37	0.0	0.00	0.0	0.00	0.00	0.0
26.5	175	1551	18.74	0.00	18.74	497	6.25	9.37	53.0	3.31	26.5	1.66	0.35	3.0
40.0	400	5333	25.08	0.00	25.08	792	8.36	9.99	63.1	3.94	50.8	3.18	0.51	2.2
50.0	625	10417	31.17	0.00	31.17	1074	10.39	11.08	68.9	4.31	64.4	4.03	0.58	2.1
60.0	900	18000	37.92	0.00	37.92	1419	12.64	12.60	74.8	4.68	75.1	4.69	0.63	2.0
70.0	1225	23583	45.52	1.04	46.56	1842	15.52	15.52	79.1	4.94	79.1	4.94	0.66	2.0
80.0	1600	42667	52.83	1.64	54.47	2347	18.16	18.16	86.2	5.39	86.2	5.39	0.68	2.0
90.0	2025	60750	60.16	2.04	62.20	2930	20.73	20.73	94.2	5.89	94.2	5.89	0.69	2.0
100.0	2500	83333	67.36	2.29	69.65	3589	23.22	23.22	103.1	6.44	103.1	6.44	0.69	2.0
110.0	3025	110917	74.52	2.46	76.98	4322	25.66	25.66	112.3	7.02	112.3	7.02	0.70	2.0
120.0	3600	144000	81.65	2.58	84.23	5129	28.08	28.08	121.8	7.61	121.8	7.61	0.70	2.0
130.0	4225	183083	88.77	2.66	91.43	6007	30.48	30.48	131.1	8.19†	131.1	8.19	0.70	2.0
140.0	4900	228667	98.43	3.87	102.30	6976	35.42	34.10	131.1	8.19	136.4	8.53	0.70	2.1
150.0	5625	281250	108.45	5.00	113.45	8054	40.71	37.82	131.1	8.19	145.0	9.06	0.70	2.2
160.0	6400	341333	118.89	6.10	124.99	9246	46.41	41.66	131.1	8.19	148.0	9.25	0.69	2.3
170.0	7225	409417	129.71	7.17	136.88	10556	52.46	45.63	131.1	8.19	154.2	9.64	0.69	2.4
180.0	8100	486000	140.91	8.23	149.14	11986	58.88	49.71	131.1	8.19	160.7	10.04	0.68	2.5
190.0	9025	571583	152.67	10.49	163.16	13547	65.85	55.12	131.1	8.19	163.8	10.24†	0.67	2.6
200.0	10000	666667	164.97	14.22	179.19	15259	73.88	61.63	131.1	8.19	163.8	10.24	0.65	2.7

\* The top width was made equal to that of Rankine's Type (see Table III.), for comparison.

† Equivalent to 8 kilos. per square centimetre.

† Equivalent to 10 kilos. per square centimetre.

The Specific Gravity of the Masonry = 2.

TABLE XI.

(See page 29.)

THEORETICAL PROFILE No. 4.

Depth of Water Below Top of Dam, in Feet.	Horizontal Thrust of Water, in Cubic Feet of Masonry	Moment of Water, in Cubic Feet of Masonry.	JOINT REFERRED TO A VERTICAL AXIS.			Total Area, in Square Feet.	Distance from Front Face to Line of Pressure, Reservoir Full, in Feet.	Distance from Back Face to Line of Pressure, Reservoir Empty, in Feet.	MAXIMA PRESSURES.				Coefficient of Friction necessary for Equilibrium	Factor of Safety against Overturning.
			Left, in Feet.	Right, in Feet.	Total, in Feet.				Reservoir Full.		Reservoir Empty.			
									In Feet of Masonry.	In Tons of 2000 lbs.	In Feet of Masonry.	In Tons of 2000 lbs.		
0.00	0	0	18.74	0.00	* 18.74	0	9.37	9.37	0.0	0.00	0.0	0.00	0.00	0.0
27.58	176	1614	18.74	0.00	18.74	517	6.25	9.37	55.3	3.74	27.7	1.88	0.34	3.0
40.00	370	4923	24.20	0.00	24.20	784	8.07	9.84	64.8	4.39	50.5	3.42	0.47	2.3
50.00	577	9615	29.87	0.00	29.87	1054	9.96	10.79	70.6	4.78	65.0	4.40	0.55	2.1
60.00	831	16615	36.25	0.00	36.25	1385	12.08	12.18	76.4	5.17	75.6	5.12	0.60	2.0
70.00	1132	26386	43.41	0.87	44.28	1788	14.76	14.76	80.7	5.46	80.7	5.46	0.63	2.0
80.00	1478	39385	50.52	1.55	52.07	2269	17.36	17.36	87.2	5.90	87.2	5.90	0.65	2.0
90.00	1871	56077	57.52	1.99	59.51	2827	19.84	19.84	95.0	6.43	95.0	6.43	0.66	2.0
100.00	2309	76923	64.45	2.27	66.72	3458	22.24	22.24	103.7	7.02	103.7	7.02	0.66	2.0
110.00	2795	102385	71.35	2.47	73.82	4161	24.61	24.61	112.7	7.63	112.7	7.63	0.67	2.0
120.00	3326	132923	78.21	2.61	80.82	4934	26.94	26.94	121.0	8.19†	122.1	8.26	0.67	2.0
130.00	3903	169000	87.68	3.87	91.55	5796	31.84	30.52	121.0	8.19	126.6	8.57	0.67	2.1
140.00	4527	210769	97.30	4.94	102.24	6765	37.00	34.08	121.0	8.19	132.3	8.96	0.67	2.2
150.00	5196	259615	107.44	6.02	113.46	7844	42.54	37.82	121.0	8.19	138.3	9.36	0.66	2.3
160.00	5912	315077	117.94	7.05	124.99	9036	48.46	41.66	121.0	8.19	144.6	9.79	0.65	2.4
170.00	6674	377692	128.81	8.05	136.86	10345	54.73	45.62	121.0	8.19	151.2	10.24‡	0.64	2.5
180.00	7483	448615	140.47	11.30	151.77	11788	61.77	51.94	121.0	8.19	151.2	10.24	0.63	2.6
190.00	8337	527615	152.60	15.09	167.69	13386	69.44	58.83	121.0	8.19	151.2	10.24	0.62	2.7
200.00	9238	615385	165.24	19.47	184.71	15148	77.72	66.36	121.0	8.19	151.2	10.24	0.61	2.9

\* The top width was made equal to that of Rankine's Type (see Table III.), for comparison.

† Equivalent to 8 kilos. per square centimetre.

‡ Equivalent to 10 kilos. per square centimetre.

The Specific Gravity of the Masonry = 2½.

TABLE XII.

(See page 29.)

THEORETICAL PROFILE NO. 5.

Depth of Water Below Top of Dam, in Feet.	Horizontal Thrust of Water, in Cubic Feet of Masonry	Moment of Water, in Cubic Feet of Masonry.	JOINT REFERRED TO A VERTICAL AXIS.			Total Area, in Square Feet.	Distance from Front Face to Line of Pressure, Reservoir Full, in Feet.	Distance from Back Face to Line of Pressure, Reservoir Empty, in Feet.	MAXIMA PRESSURES.				Coefficient of Friction necessary for Equilibrium.	Factor of Safety against Overturning.
			Left, in Feet.	Right, in Feet.	Total, in Feet.				Reservoir Full.		Reservoir Empty.			
									In Feet of Masonry.	In Tons of 2000 lbs.	In Feet of Masonry.	In Tons of 2000 lbs.		
0.00	0	0	18.74	0.00	* 18.74	0	9.37	9.37	0.0	0.00	0.0	0.00	0.00	0.0
28.62	175	1671	18.74	0.00	18.74	536	6.25	9.37	57.2	4.17	28.6	2.09	0.33	3.0
40.00	343	4571	23.45	0.00	23.45	776	7.82	9.74	66.2	4.83	49.7	3.62	0.44	2.3
50.00	535	8929	28.78	0.00	28.78	1038	9.59	10.58	72.2	5.26	65.0	4.74	0.52	2.1
60.00	771	15429	34.83	0.00	34.83	1356	11.61	11.83	77.8	5.67	76.2	5.56	0.57	2.0
70.00	1049	24590	41.37	0.85	42.22	1741	14.07	14.07	82.5	6.01	82.5	6.01	0.60	2.0
80.00	1370	36571	48.28	1.60	49.88	2206	16.63	16.63	88.4	6.45	88.4	6.45	0.62	2.0
90.00	1734	52071	54.97	2.04	57.01	2740	19.00	19.00	96.2	7.01	96.2	7.01	0.63	2.0
100.00	2141	71429	61.68	2.38	64.06	3345	21.35	21.35	104.4	7.61	104.4	7.61	0.64	2.0
110.00	2591	95071	68.34	2.60	70.94	4020	23.65	23.65	112.3	8.19†	112.3	8.19	0.64	2.0
120.00	3084	123429	77.39	3.82	81.21	4781	28.32	27.07	112.3	8.19	117.8	8.59	0.64	2.1
130.00	3619	156929	86.68	4.88	91.56	5645	33.24	30.52	112.3	8.19	123.3	8.99	0.64	2.2
140.00	4197	196000	96.43	5.90	102.33	6615	38.59	34.11	112.3	8.19	129.3	9.43	0.63	2.3
150.00	4818	241071	106.60	6.90	113.50	7694	44.34	37.83	112.3	8.19	135.6	9.89	0.63	2.4
160.00	5482	292571	117.15	7.87	125.02	8886	50.43	41.67	112.3	8.19	140.4	10.24‡	0.62	2.5
170.00	6188	350929	128.57	11.67	140.24	10213	57.45	48.43	112.3	8.19	140.4	10.24	0.61	2.6
180.00	6938	416571	140.50	15.46	155.96	11694	65.05	55.28	112.3	8.19	140.4	10.24	0.59	2.8
190.00	7730	489929	152.91	19.95	172.86	13338	73.26	62.87	112.3	8.19	140.4	10.24	0.58	3.0
200.00	8565	571429	165.96	25.02	190.98	15157	82.29	70.99	112.3	8.19	140.4	10.24	0.56	3.2

\* The top width was made equal to that of Rankine's Type (see Table III.), for comparison.

† Equivalent to 8 kilos. per square centimetre.

‡ Equivalent to 10 kilos. per square centimetre.

The Specific Gravity of the Masonry = 2½.

TABLE XIII.

(See page 29.)

## THEORETICAL PROFILE NO. 6.

Depth of Water Below Top of Dam, in Feet.	Horizontal Thrust of Water, in Cubic Feet of Masonry	Moment of Water, in Cubic Feet of Masonry.	JOINT REFERRED TO A VERTICAL AXIS.			Total Area, in Square Feet.	Distance from Front Face to Line of Pressure, Reservoir Full, in Feet.	Distance from Back Face to Line of Pressure, Reservoir Empty, in Feet.	MAXIMA PRESSURES.				Coefficient of Friction necessary for Equilibrium.	Factor of Safety against Overturning.
			Left, in Feet.	Right, in Feet.	Total, in Feet.				Reservoir Full.		Reservoir Empty.			
									In Feet of Masonry.	In Tons of 2000 lbs.	In Feet of Masonry.	In Tons of 2000 lbs.		
0.0	0	0	18.74	0.00	18.74	0	9.37	9.37	0.0	0.00	0.0	0.00	0.00	0.0
29.6	175	1729	18.74	0.00	18.74	555	6.25	9.37	59.2	4.63	29.6	2.31	0.32	3.0
40.0	320	4267	22.80	0.00	22.80	771	7.60	9.66	67.6	5.28	49.3	3.85	0.41	2.4
50.0	500	8333	27.85	0.00	27.85	1024	9.28	10.42	73.5	5.74	64.6	5.04	0.49	2.2
60.0	720	14400	33.58	0.00	33.58	1331	11.19	11.57	79.3	6.19	76.6	5.99	0.54	2.0
70.0	980	22867	39.91	0.39	40.30	1701	13.43	13.43	84.4	6.59	84.4	6.59	0.58	2.0
80.0	1280	34133	46.62	1.20	47.82	2141	15.94	15.94	89.5	6.99	89.5	6.99	0.59	2.0
90.0	1620	48600	53.20	1.72	54.92	2655	18.31	18.31	96.7	7.55	96.7	7.55	0.61	2.0
100.0	2000	66667	59.60	2.07	61.76	3238	20.59	20.59	104.9	8.19*	104.9	8.19	0.62	2.0
110.0	2420	88733	68.08	3.16	71.24	3903	24.76	23.75	104.9	8.19	109.6	8.56	0.62	2.1
120.0	2880	115200	78.97	4.20	81.17	4665	29.42	27.06	104.9	8.19	115.0	8.98	0.62	2.2
130.0	3380	146467	86.32	5.21	91.53	5529	34.53	30.51	104.9	8.19	120.8	9.44	0.61	2.3
140.0	3920	182933	96.10	6.19	102.29	6498	40.03	34.10	104.9	8.19	127.1	9.93	0.60	2.4
150.0	4500	225000	106.40	7.89	114.29	7581	46.06	38.55	104.9	8.19	131.1	10.24†	0.59	2.6
160.0	5120	273066	117.39	11.15	128.54	8796	52.84	44.65	104.9	8.19	131.1	10.24	0.58	2.7
170.0	5780	327533	128.93	15.00	143.93	10158	60.30	51.39	104.9	8.19	131.1	10.24	0.57	2.9
180.0	6480	388800	141.06	19.49	160.55	11680	68.45	58.81	104.9	8.19	131.1	10.24	0.56	3.1
190.0	7220	457286	153.82	24.66	178.48	13375	77.35	66.94	104.9	8.19	131.1	10.24	0.54	3.3
200.0	8000	533333	167.25	30.57	197.82	15257	87.03	75.83	104.9	8.19	131.1	10.24	0.52	3.5

The Specific Gravity of the Masonry = 2½.

\* Equivalent to 8 kilos. per square centimetre.

† Equivalent to 10 kilos. per square centimetre.



TABLE XIV.

(See page 31.)

INCLINED JOINTS IN THEORETICAL PROFILE No. 5.

Depth of Water Below Top of Dam, in Feet.	Horizontal Thrust of Water, in Cubic Feet of Masonry.	Moment of Water, in Cubic Feet of Masonry.	JOINT.			Angle with the Horizon.	Total Area, in Square Feet.	Distance from Front Face to Line of Pressure, Reservoir Full, in Feet.	MAXIMA PRESSURES, Reservoir Full.		Coefficient of Friction necessary for Equilibrium.
			Below Top of Dam.		Length.				In Feet of Masonry.	In Tons of 2000 lbs.	
			Front Edge.	Back Edge.							
28.62	175	1671	18.62	28.62	21.23	28° 05'	442.64	9.55	28.97	2.11	0.11
28.62	175	1671	23.62	28.62	19.38	14° 56'	489.49	7.59	44.21	3.22	0.08
28.62	175	1671	28.62	28.62	18.74	0	536.34	6.25	57.20	4.17	0.33
28.62	175	1671	33.62	28.62	21.37	13° 32'	583.20	7.49	46.75	3.41	0.58
28.62	175	1671	40.00	28.62	26.04	25° 53'	642.96	9.00	32.42	2.36	0.87
60.00	771	15429	45.00	60.00	30.12	20° 53'	1096.18	10.48	84.72	6.18	0.10
60.00	771	15429	47.50	60.00	30.19	24° 29'	1138.79	10.27	88.04	6.42	0.17
60.00	771	15429	50.00	60.00	30.50	19° 10'	1181.36	10.17	89.77	6.55	0.25
60.00	771	15429	52.50	60.00	31.12	13° 55'	1224.89	10.31	88.94	6.49	0.33
60.00	771	15429	55.00	60.00	32.20	8° 56'	1268.45	10.68	85.76	6.26	0.41
60.00	771	15429	60.00	60.00	34.83	0	1355.70	11.61	77.80	5.67	0.57
60.00	771	15429	65.00	60.00	38.46	7° 29'	1437.59	13.14	67.18	4.90	0.72
60.00	771	15429	70.00	60.00	42.55	13° 35'	1519.67	15.08	57.10	4.17	0.85
60.00	771	15429	75.00	60.00	47.31	18° 30'	1605.80	17.44	48.37	3.53	0.97
110.00	2591	95071	85.00	110.00	59.67	24° 45'	3133.69	20.78	125.80	9.18	0.40
110.00	2591	95071	87.50	110.00	60.16	21° 56'	3222.52	20.68	127.66	9.32	0.30
110.00	2591	95071	90.00	110.00	60.98	19° 10'	3311.35	20.85	126.99	9.27	0.34
110.00	2591	95071	95.00	110.00	62.76	13° 50'	3488.53	21.16	126.37	9.22	0.42
110.00	2591	95071	100.00	110.00	64.98	8° 51'	3665.71	21.60	123.83	9.04	0.49
110.00	2591	95071	110.00	110.00	70.94	0	4020.40	23.65	113.40	8.28	0.64
110.00	2591	95071	115.00	110.00	75.63	3° 48'	4197.76	26.25	101.93	7.44	0.71
110.00	2591	95071	120.00	110.00	80.64	7° 08'	4375.12	28.91	92.32	6.74	0.77
110.00	2591	95071	125.00	110.00	86.70	9° 59'	4553.71	32.68	80.98	5.91	0.83
160.00	5482	292571	110.00	160.00	91.08	33° 16'	5815.18	32.99	157.75	11.51	0.18
160.00	5482	292571	115.00	160.00	92.40	29° 08'	6118.39	33.35	158.93	11.60	0.23
160.00	5482	292571	120.00	160.00	94.12	25° 08'	6421.60	33.96	158.68	11.58	0.27
160.00	5482	292571	125.00	160.00	96.42	21° 16'	6727.60	34.93	156.68	11.44	0.32
160.00	5482	292571	130.00	160.00	99.33	17° 36'	7033.60	36.30	152.21	11.11	0.37
160.00	5482	292571	135.00	160.00	102.46	14° 07'	7337.11	37.77	147.58	10.77	0.42
160.00	5482	292571	140.00	160.00	105.82	10° 52'	7640.62	39.50	142.10	10.37	0.46
160.00	5482	292571	145.00	160.00	110.29	7° 48'	7950.97	41.95	134.55	9.82	0.50
160.00	5482	292571	150.00	160.00	114.94	5° 00'	8261.32	44.55	126.81	9.26	0.54
160.00	5482	292571	155.00	160.00	119.85	2° 24'	8573.86	47.39	119.50	8.72	0.58
160.00	5482	292571	160.00	160.00	125.02	0	8886.30	50.43	112.30	8.20	0.62
160.00	5482	292571	165.00	160.00	131.58	2° 11'	9198.94	54.60	103.10	7.52	0.65
160.00	5482	292571	170.00	160.00	137.00	4° 12'	9511.48	58.03	96.80	7.06	0.68
160.00	5482	292571	175.00	160.00	142.86	6° 01'	9823.18	61.85	90.09	6.57	0.71
160.00	5482	292571	200.00	160.00	178.57	12° 58'	11337.30	86.01	61.19	4.47	0.80

TABLE XV.

(See page 31.)

THEORETICAL PROFILE NO. 5, MODIFIED BY BOUVIER'S FORMULÆ.

Depth of Water Below Top of Dam, in Feet.	Horizontal Thrust of Water, in Cubic Feet of Masonry.	Moment of Water, in Cubic Feet of Masonry.	JOINT REFERRED TO A VERTICAL AXIS.			Total Area, in Square Feet.	Distance from Front Face to Line of Pressure, Reservoir Full, in Feet.	Distance from Back Face to Line of Pressure, Reservoir Empty, in Feet.	MAXIMA PRESSURES.				Coefficient of Friction necessary for Equilibrium.	Factor of Safety against Overturning.
			Left, in Feet.	Right, in Feet.	Total, in Feet.				Reservoir Full.		Reservoir Empty.			
									In Feet of Masonry.	In Tons of 2000 lbs.	In Feet of Masonry.	In Tons of 2000 lbs.		
100	2141	71429	62.75	2.84	65.59	3353.00	22.43	21.86	140.26	10.23	102.24	7.46	0.64	2.05
110	2591	95071	71.71	3.95	75.66	4058.25	27.00	25.24	140.31	10.24	107.28	7.83	0.64	2.15
120	3084	123429	81.04	4.95	85.99	4866.50	31.95	28.68	140.43	10.25	113.19	8.26	0.63	2.20
130	3619	156929	90.76	5.88	96.64	5779.65	37.31	32.23	140.10	10.22	119.61	8.73	0.63	2.38
140	4197	196000	100.79	6.75	107.54	6800.55	42.86	35.86	140.50	10.25	126.48	9.23	0.62	2.50
150	4818	241071	111.18	7.59	118.77	7932.10	48.78	39.60	140.48	10.25	133.57	9.75	0.61	2.60
160	5482	292571	121.89	8.56	130.45	9178.20	54.98	43.59	140.51	10.25	140.44	10.25	0.60	2.72
170	6188	350929	133.45	11.95	145.40	10557.45	62.09	50.07	140.36	10.24	140.43	10.25	0.59	2.87
180	6938	416571	145.36	15.94	161.30	12090.95	69.65	57.19	140.55	10.26	140.33	10.24	0.57	3.02
190	7730	489929	157.74	20.53	178.27	13788.80	77.83	64.91	140.39	10.25	140.47	10.25	0.56	3.19
200	8565	571429	170.56	25.79	196.35	15661.90	86.57	73.30	140.32	10.24	140.39	10.25	0.55	3.37

TABLE XVI.

(See page 36.)

THEORETICAL TYPE No. I.

Depth of Water Below Top of Dam, in Feet.	Horizontal Thrust of Water, in Cubic Feet of Masonry.	Moment of Water in Cubic Feet of Masonry.	Length of Joint, in Feet.	Total Area, in Square Feet.	Distance from Centre of Joint to Line of Pressure (Reservoir Full or Empty), in Feet.	MAXIMA PRESSURES, Reservoir Full or Empty.		Coefficient of Friction necessary for Equilibrium.	Factor of Safety against Overturning.
						In Feet of Masonry.	In Tons of 2000 lbs.		
0	0	0.0	0.00	00.0	0.00	0	0.00	0.000	0
10	21	71.4	6.55	32.7	1.09	10	0.73	0.655	2
20	84	571.4	13.09	130.9	2.18	20	1.46	0.655	2
30	193	1928.0	19.64	294.6	3.27	30	2.19	0.655	2
40	343	4571.4	26.19	523.7	4.36	40	2.92	0.655	2
50	535	8928.6	32.73	818.3	5.45	50	3.65	0.655	2
60	771	15428.6	39.28	1178.4	6.55	60	4.38	0.655	2
70	1049	24500.0	45.83	1603.9	7.64	70	5.11	0.655	2
80	1370	36571.4	52.37	2094.9	8.73	80	5.84	0.655	2
90	1734	52071.4	58.92	2651.4	9.82	90	6.57	0.655	2
100	2141	71428.6	65.47	3273.3	10.91	100	7.30	0.655	2
110	2591	94071.4	72.01	3960.7	12.00	110	8.03	0.655	2
120	3084	123428.6	78.56	4713.5	13.09	120	8.76	0.655	2
130	3619	156928.6	85.11	5531.9	14.18	130	9.49	0.655	2
140	4197	196000.0	91.65	6415.6	15.27	140	10.22	0.655	2
150	4818	241071.4	98.20	7364.9	16.37	150	10.95	0.655	2
160	5482	292571.4	104.75	8379.7	17.46	160	11.68	0.655	2
170	6188	350928.6	111.29	9459.8	18.55	170	12.41	0.655	2
180	6938	416571.4	117.84	10605.5	19.64	180	13.14	0.655	2
190	7730	489928.6	124.39	11816.6	20.73	190	13.87	0.655	2
200	8565	571428.6	130.93	13093.2	21.82	200	14.60	0.655	2

The Specific Gravity of the Masonry = 2½.

TABLE XVII.

(See page 38.)

PRACTICAL TYPE No. I.

Depth of Water Below Top of Dam, in Feet.	Horizontal Thrust of Water, in Cubic Feet of Masonry.	Moment of Water, in Cubic Feet of Masonry.	JOINT REFERRED TO A VERTICAL AXIS.			Total Area, in Square Feet.	Distance from Front Face to Line of Pressure, Reservoir Full, in Feet.	Distance from Back Face to Line of Pressure, Reservoir Empty, in Feet.	MAXIMA PRESSURES.				Coefficient of Friction necessary for Equilibrium.	Factor of Safety against Overturning.
			Left, in Feet.	Right, in Feet.	Total, in Feet.				Reservoir Full.		Reservoir Empty.			
									In Feet of Masonry.	In Tons of 2000 lbs.	In Feet of Masonry.	In Tons of 2000 lbs.		
0.00	0	0.0	20.00	0.00	20.00	0.0	10.00	0.00	0.00	0.00	0.00	0.00	0.00	0.0
10.00	21	71.4	20.00	0.00	20.00	200.0	9.64	10.00	11.1	0.81	10.0	0.73	0.11	27.8
20.00	84	571.4	20.00	0.00	20.00	400.0	8.57	10.00	28.6	2.09	20.0	1.46	0.21	7.0
30.55	200	2036.6	20.00	0.00	20.00	611.0	6.67	10.00	61.1	4.46	30.6	2.23	0.33	2.0
40.00	343	4571.4	26.19	0.00	26.19	829.2	10.25	10.42	52.3	3.82	51.0	3.72	0.41	2.9
50.00	535	8928.6	32.73	0.00	32.73	1123.8	13.61	11.57	51.6	3.77	64.5	4.71	0.47	2.8
60.00	771	15428.6	39.28	0.00	39.28	1483.9	15.74	13.14	60.2	4.39	75.2	5.49	0.52	2.5
70.00	1049	24500.0	45.83	0.00	45.83	1909.4	18.04	14.96	68.2	4.98	85.1	6.21	0.55	2.4
80.00	1370	36571.4	52.37	0.00	52.37	2400.4	20.21	16.93	77.3	5.64	94.5	6.90	0.57	2.3
90.00	1734	52071.4	58.92	0.00	58.92	2956.9	22.32	18.99	86.6	6.32	103.8	7.58	0.59	2.3
100.00	2141	71428.6	65.47	0.00	65.47	3578.8	24.41	21.09	96.4	7.04	113.1	8.25	0.60	2.2
110.00	2591	94071.4	72.01	0.00	72.01	4266.2	26.48	23.24	106.3	7.76	122.4	8.94	0.61	2.2
120.00	3084	123428.6	78.56	0.00	78.56	5019.1	28.57	25.40	116.1	8.48	131.7	9.61	0.61	2.1
130.00	3619	156928.6	85.11	0.00	85.11	5837.4	30.65	27.58	126.2	9.21	141.1	10.30	0.62	2.1
140.00	4197	196000.0	91.65	0.00	91.65	6721.2	32.72	29.77	136.2	9.94	150.5	10.98	0.62	2.1
150.00	4818	241071.4	98.20	0.00	98.20	7670.4	34.72	31.96	146.8	10.72	160.0	11.68	0.63	2.1
160.00	5482	292571.4	104.75	0.00	104.75	8685.1	36.90	34.16	156.3	11.41	169.5	12.37	0.63	2.1
170.00	6188	350928.6	111.29	0.00	111.29	9765.3	39.00	36.35	166.5	12.15	179.1	13.07	0.63	2.1
180.00	6938	416571.4	117.84	0.00	117.84	10911.0	41.10	38.55	176.7	12.90	188.7	13.76	0.63	2.1
190.00	7730	489928.6	124.39	0.00	124.39	12122.1	43.22	40.75	186.7	13.63	198.3	14.46	0.64	2.1
200.00	8565	571428.6	130.93	0.00	130.93	13398.7	45.33	42.95	196.6	14.35	207.9	15.16	0.64	2.1

The Specific Gravity of the Masonry = 2½.

NOTE.—The Profile given by this Table can be changed to another having any desired top width (equal to  $\frac{1}{10}$  the height) by simply changing the scale to which it has been drawn. To obtain a corresponding Table from the one above, proceed as follows: Let  $r$  = ratio of desired top width to that of Practical Type No. I. Divide the numbers in columns 1, 4, 5, 6, 8, 9, 10, 11, 12, 13, by  $r$ ; those in column 2 and 7 by  $r^2$ ; those in column 3 by  $r^3$ . The numbers in column 14 and 15 will remain unchanged.

TABLE XVIII.  
(See page 38.)  
THEORETICAL TYPE No. II

Depth of Water Below Top of Dam, in Feet.	Horizontal Thrust of Water, in Cubic Feet of Masonry.	Moment of Water, in Cubic Feet of Masonry.	JOINT REFERRED TO A VERTICAL AXIS.			Total Area, in Square Feet.	Distance from Front Face to Line of Pressure, Reservoir Full, in Feet.	Distance from Back Face to Line of Pressure, Reservoir Empty, in Feet.	MAXIMA PRESSURES.				Coefficient of Friction necessary for Equilibrium.	Factor of Safety against Overturning.
			Left, in Feet.	Right, in Feet.	Total, in Feet.				Reservoir Full.		Reservoir Empty.			
									In Feet of Masonry.	In Tons of 2000 lbs.	In Feet of Masonry.	In Tons of 2000 lbs.		
0.00	0	0.0	20.00	0.00	20.00	0.0	10.00	10.00	0.0	0.00	0.0	0.00	0.00	0.0
30.55	200	2036.6	20.00	0.00	20.00	611.0	6.67	10.00	61.1	4.45	30.5	2.23	0.33	2.4
40.00	343	4571.4	23.75	0.00	23.75	817.7	7.92	10.24	68.8	5.02	48.6	3.54	0.42	2.2
50.00	535	8928.6	28.83	0.00	28.83	1080.6	9.61	10.96	74.9	5.46	64.4	4.70	0.49	2.1
60.00	771	15428.6	34.68	0.00	34.68	1398.2	11.56	12.09	80.6	5.88	76.9	5.61	0.55	2.0
67.00	962	21483.1	39.08	0.00	39.08	1656.3	13.03	13.08	84.7	6.17	84.6	6.17	0.60	2.0
80.00	1370	36571.4	48.07	1.13	49.20	2230.2	16.40	16.40	90.6	6.60	90.6	6.60	0.61	2.0
90.00	1734	52071.4	54.90	1.72	56.62	2759.3	18.87	18.87	97.4	7.10	97.4	7.10	0.62	2.0
100.00	2141	71428.6	61.63	2.12	63.75	3301.1	21.25	21.25	105.4	7.68	105.4	7.68	0.64	2.0
110.00	2591	95071.4	68.31	2.40	70.71	4033.4	23.57	23.57	114.1	8.32	114.1	8.32	0.64	2.0
120.00	3084	123428.6	74.95	2.60	77.55	4774.7	25.85	25.85	123.1	8.97	123.1	8.97	0.64	2.0
130.00	3619	156928.6	81.57	2.74	84.31	5584.0	28.10	28.10	132.5	9.66	132.5	9.66	0.65	2.0
140.00	4197	196000.0	88.17	2.84	91.01	6460.6	30.34	30.34	142.0	10.35	142.0	10.35	0.65	2.0
150.00	4818	241071.4	94.76	2.92	97.68	7404.1	32.56	32.56	151.6	11.05	151.6	11.05	0.65	2.0
160.00	5482	292571.4	101.33	2.98	104.31	8414.0	34.77	34.77	161.3	11.76	161.3	11.76	0.65	2.0
170.00	6188	350928.6	107.90	3.03	110.93	9490.2	36.98	36.98	171.1	12.47	171.1	12.47	0.65	2.0
180.00	6938	416571.4	114.47	3.07	117.54	10632.6	39.18	39.18	180.9	13.19	180.9	13.19	0.65	2.0
190.00	7730	489928.6	121.03	3.10	124.13	11840.9	41.38	41.38	190.8	13.91	190.8	13.91	0.65	2.0
200.00	8565	571428.6	127.59	3.12	130.71	13115.1	43.57	43.57	200.7	14.63	200.7	14.63	0.65	2.0

The Specific Gravity of the Masonry = 2½.

NOTE.—The Profile given by this Table can be changed to another having any desired top width (equal to 1/10 the height) by simply changing the scale to which it has been drawn. To obtain a corresponding Table from the one above, proceed as follows: Let  $r$  = ratio of desired top width to that of Theoretical Type No. II. Divide the numbers in columns 1, 4, 5, 6, 8, 9, 10, 11, 12, 13 by  $r$ ; those in columns 2 and 7 by  $r^2$ ; those in column 3 by  $r^3$ . The numbers in columns 14 and 15 will remain unchanged.

TABLE XIX.  
(See page 39.)  
PRACTICAL TYPE No. 2.

Depth of Water Below Top of Dam, in Feet.	Horizontal Thrust of Water, in Cubic Feet of Masonry.	Moment of Water, in Cubic Feet of Masonry.	JOINT REFERRED TO A VERTICAL AXIS.			Total Area, in Square Feet.	Distance from Front Face to Line of Pressure, Reservoir Full, in Feet.	Distance from Back Face to Line of Pressure, Reservoir Empty, in Feet.	MAXIMA PRESSURES.				Coefficient of Friction necessary for Equilibrium.	Factor of Safety against Overturning.
			Left, in Feet.	Right, in Feet.	Total, in Feet.				Reservoir Full.		Reservoir Empty.			
									In Feet of Masonry.	In Tons of 2000 lbs.	In Feet of Masonry.	In Tons of 2000 lbs.		
0.000	0	0	20.00	0.00	20.00	0.0	10.00	10.00	0.0	0.00	0.0	0.00	0.00	0.0
18.744	75	470	20.00	0.00	20.00	374.9	8.74	10.00	25.8	1.80	18.7	1.36	0.20	8.0
30.000	192	1929	21.07	0.00	21.07	604.0	7.86	10.06	50.4	3.68	32.5	2.37	0.31	3.4
40.000	343	4571	23.89	0.00	23.89	827.2	7.99	10.37	68.9	5.03	48.3	3.53	0.41	2.4
51.967	579	10024	30.04	0.00	30.04	1146.5	10.07	11.21	75.8	5.53	67.3	4.91	0.50	2.1
60.000	771	15429	35.38	0.00	35.38	1409.1	12.26	12.17	76.6	5.59	77.1	5.63	0.54	2.1
70.000	1049	24500	42.03	0.62	42.65	1799.3	14.71	14.33	81.4	5.94	83.7	6.11	0.58	2.1
80.000	1370	36571	48.68	1.25	49.93	2262.2	17.07	16.70	88.3	6.45	90.3	6.59	0.61	2.1
90.000	1734	52071	55.33	1.87	57.20	2797.9	19.39	19.20	96.1	7.02	97.1	7.09	0.62	2.0
100.000	2141	71429	61.98	2.50	64.48	3406.2	21.73	21.78	104.4	7.62	104.2	7.61	0.63	2.0
110.000	2591	95071	68.63	3.12	71.75	4087.4	24.09	24.40	113.2	8.26	111.7	8.15	0.63	2.0
120.000	3084	123429	75.28	3.74	79.02	4840.7	26.46	27.06	121.9	8.90	119.1	8.69	0.63	2.0
130.000	3619	156929	81.93	3.74	85.67	5664.2	28.85	29.11	130.9	9.55	129.6	9.46	0.64	2.0
140.000	4197	196000	88.58	3.74	92.32	6554.2	31.22	31.20	140.0	10.22	140.0	10.22	0.64	2.0
150.000	4818	241071	95.23	3.74	98.97	7510.7	33.56	33.32	149.2	10.89	150.3	10.96	0.64	2.0
160.000	5482	292571	101.88	3.74	105.62	8533.7	35.87	35.46	158.5	11.56	160.5	11.71	0.64	2.0
170.000	6188	350929	108.53	3.74	112.27	9623.2	38.20	37.61	168.0	12.25	170.5	12.44	0.64	2.0
180.000	6938	416571	115.18	3.74	118.92	10779.2	40.50	39.78	177.5	12.95	180.7	13.18	0.64	2.0
190.000	7730	489929	121.83	3.74	125.57	12001.7	42.80	41.95	186.9	13.63	190.7	13.91	0.64	2.0
200.000	8565	571429	128.48	3.74	132.22	13290.6	45.10	44.13	196.4	14.32	200.8	14.65	0.64	2.0

The Specific Gravity of the Masonry = 2½.

NOTE.—The Profile given by this Table can be changed to another having any desired top width (equal to 1/10 the height) by simply changing the scale to which it has been drawn. To obtain a corresponding Table from the one above, proceed as follows: Let  $r$  = ratio of desired top width to that of Practical Type No. 2. Divide the numbers in columns 1, 4, 5, 6, 8, 9, 10, 11, 12, 13, by  $r$ ; those in columns 2 and 7 by  $r^2$ ; those in column 3 by  $r^3$ . The numbers in columns 14 and 15 will remain unchanged.

TABLE XX.

(See page 41.)

PRACTICAL PROFILE No. 1.

Depth of Water Below Top of Dam, in Feet.	Horizontal Thrust of Water, in Cubic Feet of Masonry	Moment of Water, in Cubic Feet of Masonry.	JOINT REFERRED TO A VERTICAL AXIS.			Total Area, in Square Feet.	Distance from Front Face to Line of Pressure, Reservoir Full, in Feet.	Distance from Back Face to Line of Pressure, Reservoir Empty, in Feet.	MAXIMA PRESSURES.				Coefficient of Friction necessary for Equilibrium.	Factor of Safety against Overturning.
			Left, in Feet.	Right, in Feet.	Total, in Feet.				Reservoir Full.		Reservoir Empty.			
									In Feet of Masonry.	In Tons of 2000 lbs.	In Feet of Masonry.	In Tons of 2000 lbs.		
0.000	0	0	5.00	0.00	5.00	0.0	2.50	2.50	0.00	0.00	0.00	0.00	0.00	0.0
4.686	5	7	5.00	0.00	5.00	23.4	2.18	2.50	6.45	0.48	4.70	0.34	0.20	8.0
10.000	22	71	5.98	0.00	5.98	51.7	2.00	2.60	17.25	1.26	12.10	0.89	0.41	2.4
12.992	36	157	7.51	0.00	7.51	71.7	2.52	2.81	18.95	1.39	16.85	1.23	0.50	2.1
15.000	48	241	8.85	0.00	8.85	88.1	3.07	3.05	19.15	1.40	19.30	1.41	0.54	2.1
20.000	86	571	12.17	0.32	12.49	141.4	4.27	4.18	22.10	1.62	22.60	1.65	0.61	2.1
25.000	134	1116	15.50	0.62	16.12	212.9	5.44	5.45	26.10	1.92	26.05	1.90	0.63	2.0
30.000	193	1929	18.82	0.94	19.76	302.6	6.62	6.77	30.50	2.23	29.80	2.18	0.63	2.0
35.000	262	3063	22.14	0.94	23.08	409.7	7.81	7.80	35.00	2.51	35.00	2.55	0.64	2.0
40.000	343	4571	25.47	0.94	26.41	533.4	8.97	8.87	39.65	2.39	40.15	2.93	0.64	2.0
45.000	434	6509	28.80	0.94	29.74	673.7	10.13	9.95	44.40	3.24	45.20	3.30	0.64	2.0
50.000	535	8929	32.12	0.94	33.06	830.7	11.28	11.04	49.10	3.58	50.20	3.67	0.64	2.0

The Specific Gravity of the Masonry = 2½

TABLE XXI.

(See page 41.)

PRACTICAL PROFILE NO. 2.

Depth of Water Below Top of Dam, in Feet.	Horizontal Thrust of Water, in Cubic Feet of Masonry	Moment of Water, in Cubic Feet of Masonry.	JOINT REFERRED TO A VERTICAL AXIS.			Total Area, in Square Feet.	Distance from Front Face to Line of Pressure, Reservoir Full, in Feet.	Distance from Back Face to Line of Pressure, Reservoir Empty, in Feet.	MAXIMA PRESSURES.				Coefficient of Friction necessary for Equilibrium.	Factor of Safety against Overturning.
			Left, in Feet.	Right, in Feet.	Total, in Feet.				Reservoir Full.		Reservoir Empty.			
									In Feet of Masonry.	In Tons of 2000 lbs.	In Feet of Masonry.	In Tons of 2000 lbs.		
0.000	0	0	10.00	0.00	10.00	0.0	5.00	5.00	0.0	0.00	0.00	0.00	0.00	0.0
9.372	19	59	10.00	0.00	10.00	93.7	4.37	5.00	12.9	0.95	9.4	0.68	0.20	8.0
15.000	48	241	10.54	0.00	10.54	151.0	3.93	5.03	25.2	1.84	16.3	1.69	0.31	3.4
20.000	86	571	11.95	0.00	11.95	206.8	4.00	5.18	34.5	2.52	24.2	1.77	0.41	2.4
25.983	145	1253	15.02	0.00	15.02	286.6	5.04	5.60	37.9	2.77	33.7	2.45	0.50	2.1
30.000	193	1929	17.69	0.00	17.69	352.3	6.13	6.08	38.3	2.80	38.6	2.82	0.54	2.1
35.000	262	3063	21.02	0.31	21.33	449.8	7.36	7.16	40.7	2.97	41.9	3.06	0.58	2.1
40.000	343	4571	24.34	0.63	24.97	565.6	8.54	8.35	44.2	3.23	45.2	3.30	0.61	2.1
45.000	434	6509	27.66	0.94	28.60	699.5	9.70	9.60	48.1	3.51	48.6	3.55	0.62	2.0
50.000	535	8929	30.99	1.25	32.24	851.6	10.87	10.89	52.2	3.81	52.1	3.81	0.63	2.0
55.000	648	11884	34.32	1.56	35.88	1021.9	12.05	12.20	56.6	4.13	55.9	4.08	0.63	2.0
60.000	771	15429	37.64	1.87	39.51	1210.2	13.23	13.53	61.0	4.45	59.6	4.35	0.63	2.0
65.000	905	19616	40.97	1.87	42.84	1416.1	14.43	14.55	65.5	4.78	64.8	4.73	0.64	2.0
70.000	1049	24500	44.29	1.87	46.16	1638.6	15.61	15.60	70.0	5.11	70.0	5.11	0.64	2.0
75.000	1205	30134	47.62	1.87	49.49	1877.7	16.78	16.66	74.6	5.45	75.2	5.48	0.64	2.0
80.000	1371	36571	50.94	1.87	52.81	2133.4	17.94	17.73	79.3	5.78	80.3	5.86	0.64	2.0
85.000	1547	43866	54.27	1.87	56.14	2405.8	19.10	18.80	84.0	6.13	85.3	6.22	0.64	2.0
90.000	1735	52071	57.59	1.87	59.46	2694.8	20.25	19.89	88.8	6.48	90.4	6.59	0.64	2.0
95.000	1933	61241	60.92	1.87	62.79	3000.4	21.40	20.98	93.5	6.82	95.4	6.96	0.64	2.0
100.000	2141	71429	64.24	1.87	66.11	3322.7	22.55	22.07	98.2	7.16	100.4	7.33	0.64	2.0

The Specific Gravity of the Masonry = 2½

TABLE XXII.

(See page 41.)

PRACTICAL PROFILE NO. 3.

Depth of Water Below Top of Dam, in Feet.	Horizontal Thrust of Water, in Cubic Feet of Masonry	Moment of Water, in Cubic Feet of Masonry.	JOINT REFERRED TO A VERTICAL AXIS.			Total Area, in Square Feet.	Distance from Front Face to Line of Pressure, Reservoir Full, in Feet.	Distance from Back Face to Line of Pressure, Reservoir Empty, in Feet.	MAXIMA PRESSURES.				Coefficient of Friction necessary for Equilibrium	Factor of Safety against Overturning.
			Left, in Feet.	Right, in Feet.	Total, in Feet.				Reservoir Full.		Reservoir Empty.			
									In Feet of Masonry.	In Tons of 2000 lbs.	In Feet of Masonry.	In Tons of 2000 lbs.		
0.000	0	0.0	18.74	0.00	18.74	0.00	9.37	9.37	0.00	0.00	0.00	0.00	0.00	0.0
16.585	59	325.9	18.74	0.00	18.74	310.80	8.32	9.37	22.16	1.62	16.59	1.21	0.19	8.9
20.000	86	571.4	18.86	0.00	18.86	374.98	7.93	9.41	29.37	2.14	20.01	1.46	0.23	6.2
30.000	193	1928.5	20.56	0.00	20.56	570.33	7.67	9.51	48.87	3.57	33.97	2.48	0.34	3.3
40.000	343	4571.4	24.52	0.00	24.52	793.65	8.78	9.98	59.93	4.38	50.43	3.68	0.43	2.5
50.000	535	8928.6	29.95	0.00	29.95	1065.69	10.65	10.92	66.41	4.84	64.49	4.70	0.50	2.2
60.000	771	15435.6	35.71	0.43	36.14	1395.80	12.44	12.64	74.72	5.45	73.44	5.35	0.55	2.1
70.000	1049	24500.0	41.81	0.87	42.68	1789.57	14.40	14.59	82.84	6.04	81.72	5.66	0.59	2.0
80.000	1370	36571.4	48.29	1.30	49.59	2250.59	16.62	16.72	90.28	6.58	89.73	6.54	0.61	2.0
90.000	1734	52071.4	55.15	1.73	56.88	2782.60	19.16	19.01	96.81	7.06	97.58	7.12	0.62	2.0
100.000	2141	71428.6	62.41	2.17	64.58	3389.58	22.06	21.45	102.38	7.46	105.35	7.68	0.63	2.0
110.000	2591	95071.4	70.11	2.60	72.71	4075.87	25.37	24.02	106.87	7.79	113.12	8.25	0.63	2.1
120.000	3084	123428.6	78.28	3.05	81.93	4848.70	29.16	27.32	110.34	8.05	118.31	8.63	0.63	2.1
130.000	3619	156928.6	86.94	4.71	91.65	5716.17	33.45	30.75	112.90	8.23	123.92	9.04	0.63	2.2
140.000	4197	196000.0	96.13	5.76	101.89	6683.36	38.28	34.28	114.51	8.35	129.96	9.48	0.63	2.3
150.000	4818	241071.4	105.90	6.82	112.72	7755.93	43.69	37.95	115.21	8.40	136.23	9.94	0.62	2.4
160.000	5482	292571.4	116.32	7.87	124.19	8939.87	49.72	41.75	115.02	8.39	142.74	10.48	0.61	2.5
170.000	6188	350928.6	127.44	12.16	139.60	10258.14	56.51	48.88	115.45	8.42	139.54	10.18	0.60	2.6
180.000	6938	416571.4	139.34	16.45	155.79	11734.32	64.24	56.05	114.93	8.38	138.69	10.11	0.59	2.8
190.000	7730	489928.6	152.14	20.73	172.87	13376.80	72.98	63.27	113.52	8.28	139.59	10.18	0.58	3.0
200.000	8565	571428.6	165.96	25.02	190.98	15195.10	82.75	70.62	111.40	8.13	141.72	10.33	0.56	3.2

The Specific Gravity of the Masonry = 2.4.

TABLE XXIII.  
HIGH MASONRY DAMS, INCLUDING ONLY STRUCTURES OVER 100 FEET HIGH.\*  
(Dimensions in Feet.)

No.	Dam.	Location.	Date of Construction.	Depth of Water.	Height above Bed-rock.	Width.		Length on Crest.	Plan.
						Top.	Base.		
1	Alicante	Spain	1579-1594	127	135	65.6	110.6	100	Curved
2	Puentes †	"	1785-1791	154	104	35.7	144.3	925	Polygonal
3	Val de Inferno	"	1785-1791	.....	116	41.1	137.0	330	"
4	Zola	France	About 1843	120	123	10.0	41.8	205	Curved
5	Lozoya	Spain	1852	94	105	22.0	128.0	238	Straight
6	Furens	France	1862-1866	113	171	9.9	161.0	328	Curved
7	Ternav.	"	1865-1868	113	125	13.1	81.7	.....	"
8	Habra †	Algiers	1865-1873	117	125	14.1	95.0	1476	Straight
9	Ban	France	1867-1870	138	157	16.4	127.0	.....	Curved
10	Gilleppe	Belgium	1869-1875	148	154	40.2	216.5	771	"
11	Villar	Spain	1870-1878	162	170	14.8	154.5	546	"
12	Pas du Riot	France	1872-1878	.....	113	.....	.....	.....	"
13	Poona	India	.....	.....	108	13.8	60.8	5136	Polygonal
14	Hijar	Spain	1880	.....	141	10.4	147.0	236	Curved
15	Gorzente	Italy	1880-1883	121	126	13.1	99.6	492	"
16	Lagolungo	"	About 1883	.....	144	16.4	.....	.....	"
17	Gran Cheurfas	Algiers	1882-1884	.....	131	13.1	134.5	509	Straight
18	Hamiz	"	1885	115	135	16.4	91.2	532	"
19	Vyrnwy	England	1882-1889	.....	146	20.0	117.8	1350	"
20	Tansa	India	1886-1891	.....	118	12.0	100.0	8800	Curved
21	San Mateo	United States	1887-1889	.....	170	20.0	176.0	700	"
22	Tache	France	1888-1892	.....	161	13.1	.....	.....	"
23	Bhai	India	.....	.....	130	12.0	74.0	4067	"
24	Beitaco	"	1888-1890	.....	110	14.0	110.0	580	Curved
25	Periar	"	1888-1897	.....	180	12.0	136.0	1200	Straight
26	Mouche	France	About 1890	95	125	11.5	.....	1346	"
27	Lagrange	United States	1890	.....	125	24.0	90.0	320	Curved
28	Titus	"	1890-1895	.....	135	18.0	75.0	534	Straight
29	Hemmet	"	1891-1895	.....	136	10.0	100.0	.....	Curved
30	Butte City	"	1892	.....	120	10.0	83.0	350	"
31	New Croton	"	1892-1907	150	297	22.0	200.0	2108	Straight
32	Echape	France	1894-1898	116	121	17.0	88.6	541	Curved
33	Cotalay	"	1900-1904	121	144	16.7	.....	509	"
34	Lake Cheesman	United States	1900-1904	.....	232	18.0	176.0	.....	"
35	Spier Falls	"	1900-1905	80	154	.....	.....	1369	Straight
36	Poonton	"	1900-1905	105	114	17.0	77.0	2150	"
37	Wachusett	"	1900-1906	.....	228	25.8	187.0	1476	"
38	Andenon	France	1901-1904	107	123	15.4	93.8	420	Curved
39	Cliff	Germany	1901-1904	.....	190	18.0	165.7	1037	"
40	Komolau	Austria	1901-1904	.....	139	13.1	98.4	509	"
41	Cher	France	"	148	157	15.4	141.1	.....	"
42	Roosevelt	United States	"	.....	280	20.0	170.0	780	"
43	Pathfinder	"	"	210	210	10.0	.....	.....	"
44	Shoshone	"	"	235	310	10.0	108.0	.....	"
45	Cross River	"	"	106	170	23.0	114.1	1012	Straight
46	Croton Falls	"	"	100	170	23.0	127.7	1795	"

\* (1) Some high dams in Germany, mentioned on page 89, are not included in this table, on account of lack of sufficient information. (2) Where the waste-weir joins the dam, it is included in the length of the dam.

† The Habra Dam was ruptured on April 30, 1881.

TABLE XXIV.  
HIGH EARTH DAMS.\*

Name of Dam or Reservoir.	Location.	EMBANKMENT.		SLOPES.		Avail. Depth, Feet.
		Maximum Height, Feet.	Top Width, Feet.	Water.	Rear.	
San Leandro	California	125	28	.....	.....	.....
Tabaud	"	123	20	3 on 1	2½ on 1	70
Druid Hill	Maryland	119	60	4 on 1	2 on 1	82
Dodder	Ireland	115	22	3½ on 1	3 on 1	.....
Titicus Dam	New York	110	30	2 on 1	2½ on 1	.....
Mudduk Tank	India	108	.....	3 on 1	2½ on 1	.....
Cummum Tank	"	102	.....	3 on 1	1 on 1	90
Dale Dike	England	102	12	2½ on 1	2½ on 1	.....
Marengo	Algeria	101	.....	.....	.....	.....
Torside	England	100	.....	.....	.....	84
Yarrow	"	100	24	3 on 1	2 on 1	.....
Honey Lake	California	96	20	3 on 1	2 on 1	.....
Pilarcitos	"	95	25	2½ on 1	2½ on 1	.....
San Andres	"	95	25	3½ on 1	3 on 1	.....
Temescal	"	95	12	3 on 1	2 on 1	.....
Waghad	India	95	6	3 on 1	2 on 1	81
Bradfield	England	95	12	2½ on 1	2½ on 1	.....
Oued Meurad	Algeria	95	.....	.....	.....	.....
St. Andrews	Ireland	93	25	.....	.....	.....
Edgelaw	Scotland	93	.....	3 on 1	2½ on 1	.....
Woodhead	England	90	.....	.....	.....	72
Tordoff	Scotland	85	10	3 on 1	2½ on 1	.....
Naggar	India	84	.....	.....	.....	.....
Vahar	"	84	24	3 on 1	2½ on 1	.....
Roseberry	Scotland	84	.....	.....	.....	.....
Atlanta	Georgia	82	40	.....	.....	.....
Roddlesworth	England	80	16	3 on 1	2½ on 1	68
Gladhouse	Scotland	79	12	3 on 1	2½ on 1	68½
Rake	England	78	.....	3 on 1	2 on 1	.....
Silsden	"	78	.....	3 on 1	2 on 1	.....
Glencourse	Scotland	77	.....	3 on 1	.....	58
Leeshaw	England	77	.....	.....	.....	.....
Wayoh	"	76	22	3 on 1	2½ on 1	.....
Ekruk Tank	India	76	20	3 on 1	2 on 1	65
Nehr	"	74	8	.....	.....	.....
Middle Branch	New York	73	.....	.....	.....	.....
Leeming	Ireland	73	10	3 on 1	2 on 1	50
South Fork	Pennsylvania	72	20	2 on 1	1½ on 1	.....
Anasagur	India	70	20	4 on 1	.....	.....
Pangran	"	68	8	.....	.....	42
Harlaw	Scotland	67	.....	.....	.....	64
Lough Vartry	Ireland	66	28	3 on 1	2½ on 1	60
La Mesa	California	66	20	1½ on 1	1½ on 1	60
Amsterdam	New York	65	.....	.....	.....	.....
Mukti	India	65	10	3 on 1	2 on 1	41
Snake River	California	64	12	2 on 1	1½ on 1	.....
Stubken	Ireland	63	24	3 on 1	2 on 1	.....
Den of Ogil	Scotland	60	.....	.....	.....	50
Loganlea	"	59	10	3 on 1	2½ on 1	55
Ashti	India	58	6	3 on 1	2 on 1	42
Cedar Grove	New Jersey	55	18	3 on 1	2 on 1	50

\* Taken from "Earth Dams," by Burr Bassell, M. Am. Soc. C. E., by permission of the publishers *Engineering News*.

TABLE XXV.

## EQUIVALENTS OF THE METRIC MEASURES, ACCORDING TO THE UNITED STATES STANDARD

1 metre = 39.3685 inches = 3.28071 feet.

1 square metre = 10.763058 square feet.

1 hectare = 107630.58 square feet = 2.47086 acres.

1 litre = 61.0165 cubic inches.

1 cubic metre = 35.3105 cubic feet = 264.141 U. S. liquid gallons.

1 kilogramme = 2.204737 pounds avoirdupois.

1 kilogramme per square centimetre = 1.02421 tons of 2000 pounds per square foot.

METRES.	METRES INTO FEET.									
	.0	.1	.2	.3	.4	.5	.6	.7	.8	.9
	Feet.	Feet.	Feet.	Feet.	Feet.	Feet.	Feet.	Feet.	Feet.	Feet.
1	3.281	3.609	3.937	4.265	4.593	4.921	5.249	5.577	5.905	6.233
2	6.561	6.889	7.218	7.546	7.874	8.202	8.530	8.858	9.186	9.514
3	9.842	10.170	10.498	10.826	11.154	11.482	11.811	12.139	12.467	12.795
4	13.123	13.451	13.779	14.107	14.435	14.763	15.091	15.419	15.747	16.075
5	16.404	16.732	17.060	17.388	17.716	18.044	18.372	18.700	19.028	19.356
6	19.684	20.012	20.340	20.668	20.996	21.324	21.653	21.981	22.309	22.637
7	22.965	23.293	23.621	23.949	24.277	24.605	24.933	25.261	25.589	25.917
8	26.246	26.574	26.902	27.230	27.558	27.886	28.214	28.542	28.871	29.199
9	29.527	29.855	30.183	30.511	30.840	31.168	31.496	31.824	32.152	32.480
10	32.807	33.135	33.463	33.791	34.119	34.447	34.775	35.103	35.432	35.760

This Table can be used for smaller or larger numbers by changing the position of the decimal-point.



CALCULATION OF THEORETICAL PROFILE No. 6 (TABLE XIII, PAGE 394) BY  
THE EQUATIONS GIVEN IN PART I, CHAPTER III.

ASSUMED DATA.

Top-width of profile . . . . .	18.74 feet
Specific gravity of masonry . . . . .	$2\frac{1}{2}$
Limiting pressure at front face . . . . .	16,380 lbs. per square foot
Limiting pressure at back face . . . . .	20,480 lbs. per square foot
Unit of weight . . . . .	1 cubic foot of masonry
Surface of water assumed at top of dam.	

The top-width and limiting pressures are the same as those assumed by Professor Rankine for his profile type (Plate III, Table III). The limiting pressures at the front and back face are respectively equal to 8 and 10 kilogrammes per square centimetre.

We first calculate to what depth both faces may remain vertical by formula (1) on page 21. Substituting the proper values for the known quantities, we obtain

$$d = 18.74\sqrt{\frac{5}{2}} = 29.60.$$

We check this result by calculating  $v$  by formula (G), page 20,

$$v = \frac{1729}{555} = 3.12.$$

As  $m = 9.37$ ,  $u$  will be  $6.25 = \frac{a}{3}$ , which proves our calculation to be correct.

We calculate next the length of the joint at a depth of 40 feet by equation (2), page 22. Substituting the values for the known quantities, we get

$$x^2 + \left(\frac{4 \times 555}{10.4} + 18.74\right)x = \frac{6}{10.4}(555 \times 9.37 + 4267) + 351.19;$$

whence  $x = 22.80.$

We now check our calculation by moments, assuming a vertical axis of moments 50 feet (any convenient distance) up-stream from the back face of the dam.

Weights.	×	Lever-arms.	=	Moments.
555	×	59.37	=	32950
195	×	59.37	=	11577
21	×	70.09	=	1472
771	×	59.66	=	45999

The lever-arm 59.66 is obtained by dividing the sum of the moments by the sum of the weights.

From formula (G), page 20, we find  $v = 5.54$ . Knowing  $m$  and  $v$  we find  $u = 7.60 = \frac{x}{3}$ .

which proves the correctness of our calculations. It is convenient to make a sketch (Fig. 119), showing how the joint calculated is divided by  $P$  and  $P'$ .

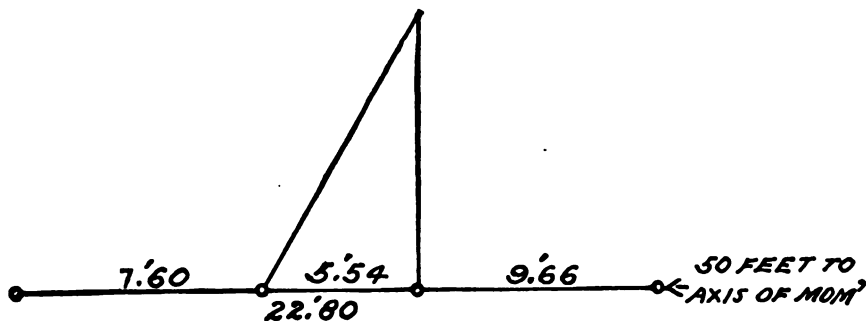


FIG. 119.

We now calculate the length of the joint at a depth of 50 feet by equation (2), page 22. Substituting the values of the known quantities, we obtain

$$x^2 + \left( \frac{4 \times 771}{10} + 22.8 \right) x = \frac{6}{10} (771 \times 9.66 + 8333) + 519.84;$$

whence  $x = 27.82.$

In checking this calculation by moments, we carry forward the total weight and total moment of the previous calculation and add the weight and moment of the course just determined, which is divided into a rectangle and triangle for convenience.

Weights.	Lever-arms.	Moments.
771	.....	45999
228	61.40	13999
25	74.47	1862
<hr/>	<hr/>	<hr/>
1024	60.41	61860

From formula (G), page 20, we obtain

$$v = 8.14.$$

The joint will be divided by  $P$  and  $P'$  as follows:

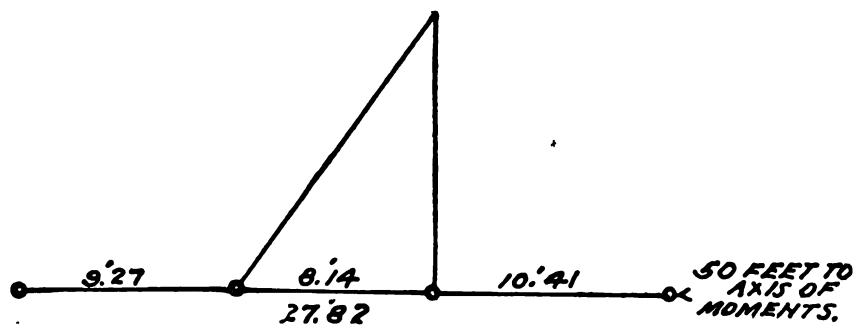


FIG. 120.

The calculations for the first three courses of the dam suffice to show the writer's method of determining the length of a joint and of verifying it by moments. The use of the different equations which must be applied successively in determining the lengths of the joints are explained in Part I, Chapter III.

## BIBLIOGRAPHY.

### MASONRY DAMS.

- SAZILLY. Note sur un type de profil d'égale résistance, proposé pour les murs de réservoirs d'eau. *Annales des Ponts et Chaussées*, 1853, 2<sup>e</sup> semestre, pp. 191-222.
- Sul Serbatoio di Losoya*. *Rivista de Obras publicas*. Madrid, 1854.
- AYMARD. Irrigations du Midi de l'Espagne. Études sur les grands travaux hydrauliques et le régime administratif des arrosages de cette contrée. Paris, 1864.
- GRÆFF. Rapport sur la forme et le mode de construction du barrage du gouffre d'Enfer, sur le Furens et des grands barrages en général. *Annales des Ponts et Chaussées*, 1866, Septembre et Octobre.
- DELOCRE. Mémoire sur la forme du profil à adopter pour les grands barrages en maçonnerie des réservoirs. *Annales des Ponts et Chaussées*, 1866, 2<sup>e</sup> semestre, p. 212.
- MARCHAL. Barrage de l'Habra sur l'Habra. *Annales du Génie Civil*, 1868, pp. 33-46.
- LAFONT. Sur la repartition des pressions dans les murs de soutènement et des réservoir. *Annales des Ponts et Chaussées*, 1868.
- LE BLANC. Stabilité des constructions. *Annales des Ponts et Chaussées*, No. 242, 1869.
- KRANTZ. Étude sur les murs de réservoirs. Paris, 1870. Translated by Mahan. New York, 1883.
- RANKINE. Report on the Design and Construction of Masonry Dams. *Miscellaneous Scientific Papers*. London, 1881. Also in *The Engineer*, Jan. 5, 1872.
- TOURNADRE. Description d'un barrage exécuté sur la rivière du Verdon et de la prise d'eau du canal du Verdon en Provence. *Annales des Ponts et Chaussées*, 1872, 1<sup>er</sup> semestre, pp. 428-455.
- TULLOCH. Water-supply of Bombay. *Professional Papers on Indian Engineering (Paper 68)*, 1873.
- DE LAGRENÉ. Cours de navigation intérieur, tome II, part III, chapitre III. Paris, 1873.
- SPON'S Dictionary of Engineering. "Damming," vols. 3, 4; "Retaining Walls," vol. 8. 1874.
- CROES, J. J. R. Memoir on the Construction of a Masonry Dam. *Proc. Am. Soc. C. E.*, 1874.
- MONTGOLFIER. Travaux exécutés pour la conduite d'eau de la ville de Saint-Etienne. *Annales des Ponts et Chaussées*, Février, 1875.
- POCHET. Mémoire sur la mise en valeur de la plaine de l'Habra, Province d'Oran, Algérie. *Annales des Ponts et Chaussées*, 1875, Avril, pp. 261-389.
- BOUVIER. Calculs de résistance des grands barrages en maçonnerie. *Annales des Ponts et Chaussées*, 1875, Août, pp. 173-205.
- INTZE. Ueber die erforderliche Stärke der gebräuchlichsten Formen von Quaimauern, Stützmauern und Thalsperren, mit Rücksicht auf die Widerstandfähigkeit der Materialien und etwaige Fehler bei der Ausführung. *Deutsche Bauzeitung*, 1875.
- GILEPPE DAM. *Proc. Inst. C. E.*, vol. 48, p. 312; vol. 56, p. 337, 1876. *Engineering News*, Dec. 25, 1886.
- MCMASTERS. *High Masonry Dams*. New York, 1876.
- HARLACHER. Das Reservoir im "bösen Loch" bei Komatau. *Technische Blätter; Vierteljahrsschrift des deutschen polytechnischen Vereins*, 7ter Jahrgang.
- HUMBER, W. *A Comprehensive Treatise on the Water-supply of Cities and Large Towns*, p. 103. London, 1876.
- PELLETREAU. Mémoire sur les murs qui supportent une poussée d'eau. *Annales des Ponts et Chaussées*, 1876, Octobre; 1877, Août et Novembre.
- BODSON, DETIENNE et LECLERQ. Mémoire sur le Barrage de la Gileppe. 1877.
- DOBSON. Geelong Water-supply, Victoria, Australia. *Proc. Inst. C. E.*, vol. 56, p. 94, 1878.
- DEBAUVE. *Manuel de l'Ingénieur des Ponts et Chaussées*. Paris, 1878.
- VILLARS RESERVOIR. *Rivista de Obras publicas*, toma xxiii.
- KUHN. Die Thalsperre der Gileppe bei Verviers. *Zeitschrift für Baukunde*, 1879, p. 185; und im *Civilingenieur*, 1879, Heft 1.
- LE barrage du Hamiz en Algérie. *Annales Industrielles*, 1879 p. 769, et *Nouvelles Annales de la Construction*, 1879, p. 141.
- CHAPINEAU. Études sur le désenvasement des barrages. 1880.
- LE barrage du Chagres à Panama. *Annales Industrielles*, 1880, p. 674.
- PLANAT. Murs de réservoirs. *Semaine des Constructeurs*, 1880 (iv. p. 553).

- DE LESSEPS. Le barrage du Furens. Compte rendu de l'académie des sciences. 1880 (xc p. 1148). — Le barrage de la Gileppe. 1880 (xci. p. 151).
- MIEG. Le barrage de la Gileppe. Bulletin de la Société industrielle de Mulhouse. 1880, p. 44.
- BURSTING of Habra Dam. Proc. Inst. C. E., vol. 70, p. 447, 1881.
- CAMÉRE. Mémoire sur divers barrages en course d'exécution en France. Congrès international du Génie Civil, 1881.
- DU COURNAU. Rupture du barrage de Perregaux (Habra) Génie Civil, 1881-82, p. 439.
- VILLAR DAM. Proc. Inst. of C. E., vol. 71, p. 379, 1882.
- CRUGNOLA. Sui Muri di Sostegno e sulle Traverse dei Serbatoi d'Acqua. Torino, 1883.—La rottura della traversa dell'Habra nella Provincia d'Oran (Algeria). Ingegneria civile e le arti industriali. Torino, 1882.—La traversa della Gileppe in vicinanza di Verviers. Ingegneria civile e le arti industriali. Torino, 1882.
- FANNING, J. I. A Treatise on Hydraulic and Water-supply Engineering, chap. x. New York, 1882.
- CERADINI. Calcolo dei muri di sostegno d'acqua. Politecnico, 1883 (xxxi. p. 217).
- TORRICELLI. Dei grandi bacini per irrigazione. Roma, 1885. — Sul calcolo delle alte dighe di ritenuta. Giornale del Genio Civile. 1884.
- CASTIGLIANO. Muri di sostegno delle acque. Politecnico, 1884, pp. 32-67.
- GOULD. Strains in High Masonry Dams. Van Nostrand's Eclectic Engineering Magazine, 1884 (xxx. p. 265).
- DEACON. Report as to the Vyrnwy Masonry Dam. Liverpool, 1885.
- HÉTIER. Études sur la résistance des matériaux dans les murs de soutènement. Annales des Ponts et Chaussées, 1885, 1<sup>er</sup> semestre, p. 795.
- COVENTRY. The Design and Stability of Masonry Dams. Proc. Inst. C. E., vol. 85 (Paper 2110), session 1885 to 1886.
- HÉTIER. Calcul du Profil des Murs Barrages. Annales des Ponts et Chaussées, Avril, 1886.
- WILLIOT. Murs de Retenue des Grandes Réservoirs. Génie Civile, Tome XII., No. 13; 28 Janvier, 1888.
- FRANCIS, J. B. High Walls or Dams to resist the Pressure of Water. Transactions Am. Soc. C. E., October 1888.
- HILL, J. W. Masonry Dam at Eden Reservoir, Cincinnati. Trans. Am. Soc. C. E., vol. 16 (June, 1887), p. 261.
- QUAKER BRIDGE DAM. See Reports made on this project to the Aqueduct Commission of the City of New York, by B. S. Church, Chief Engineer, July 28, 1887; A. Fteley, Consulting Engineer, July 25, 1887; J. P. Davis, J. J. R. Croes and W. F. Shunk, a Board of Experts, on October 1, 1888.
- Abstracts of these reports will be found in Engineering News for 1888.
- MARICHAL, A. Description of the Gileppe Dam. Proceedings Engineers' Club of Philadelphia, vol. 6 (1886-88), p. 243.
- SCHUYLER, J. D. The Sweetwater Dam, San Diego, Cal. Trans. Am. Soc. C. E., vol. 19 (November, 1888), p. 201.
- WILSON, H. M., gives description of dams in India in his report on "Irrigation in India," published in the XIIth Annual Report of the U. S. Geological Survey (1890-91).
- VYRNWY DAM. Full description in Engineering (London), January 8, 1886. Abstract in Engineering News, January 30, 1886. See also, *id.*, June 19, 1886, and December 29, 1888; Engineering (London), June 27, 1890; Railroad and Engineering Journal, September, 1892.
- FOLSOM DAM. Engineering News, October 17, 1891, p. 364; also, Railroad and Engineering Journal, July, 1892, p. 315.
- TANSA DAM. Bombay Water-works. Engineering Record, December 19, 1891, p. 40; Engineering News, June 30, 1892, p. 646.
- NEW CROTON DAM. Engineering News, June 2, 1892, and October 20, 1898; also, Engineering Record, June 11, 1898, and Aug. 16, 1902.
- BHATGUR DAM, India. Railroad and Engineering Journal, August, 1892, p. 357; also, Engineering News, April 27, 1893.
- BUTTE CITY DAM. Engineering News, December 15, 22, 1892.
- SODOM DAM, New York. Paper by W. McCulloh, Trans. Am. Soc. C. E., vol. 28, p. 185. Abstract in Engineering Record, June 3, 1893.
- BEETALOO CONCRETE DAM. Engineering Record, September 23, 1893, p. 263.
- PELLETREAU, A. Note sur les profils sans extensions des grands barrages en maçonnerie. Annales des Ponts et Chaussées, May, 1894.
- KREUTER, F. The Design of Masonry Dams. Minutes of Proceedings Inst. C. E., vol. 115 (1893-94), p. 63.
- AUSTIN DAM, Texas. Engineering News, January 26, 1893, and August 2, 1894; Engineering Magazine, November, 1894.
- LAGRANGE DAM. Description. Engineering Record, March 3, 1894; Engineering News, March 29, 1894.
- CHEMNITZ DAM, Germany. Engineering Record, July 28, 1894; also, Scientific American Supplement, November 10, 1894.
- GOULD, E. S. The Dunnings Dam. Trans. Am. Soc. C. E., vol. 22, November, 1894, p. 389; also, Engineering News, October 18, 1894; Engineering Record, October 20, 1894.
- FAILURE OF THE BOUSEY DAM. Engineering (London), May 3, 1895; The Engineer (London), May 31, 1895, January 17, 1896, and Sep-

- tember 10, 1897; *Le Génie Civil*, May 11, 1895, July 10, 17, 24, 1897; *Proc. Inst. C. E.* vol. 125; *Engineering News*, May 9, 23, 1898.
- PERIAR DAM, India. *Engineering* (London), Nov. 25, Dec. 2, 9, 1892; *Engineering Record*, Dec. 31, 1892; *Scientific American Supplement*, April 8, 1899; *Engineering News*, Oct. 24, 1901.
- VAN BUREN, J. D. *High Masonry Dams*. *Trans. Am. Soc. C. E.*, vol. 34 (December, 1895), p. 493.
- WILSON, H. M. *Irrigation Engineering*. New York, 1896; pp. 384 to 436.
- REMSCHIED DAM, Germany. *Engineering News*, January 30, 1896; *The Engineer* (London), July 31, 1896.
- DEACON, G. F. *The Vyrnwy Works for the Water-supply at Liverpool*. *Minutes of Proceedings Inst. C. E.*, vol. 126, Part IV, page 24 (Oct., 1896).
- GILEPPE DAM. *Engineering Record*, Oct. 17, 1896.
- SCHUYLER, J. D., gives descriptions of Masonry Dams in the Western States in his report on "Reservoirs for Irrigation," published in the XVIIIth Annual Report of the U. S. Geological Survey (1896-97).
- COURTNEY, C. F. *Masonry Dams from Inception to Completion*. London, 1897.
- PELLETREAU. *Mémoire sur les profils des barrages en maçonnerie*. *Annales des Ponts et Chaussées*, 1. Trimestre, 1897.
- HOLYOKE DAM, Massachusetts. *Engineering News*, May 13, 1897; *Engineering Record*, July 22, 1899.
- CONCRETE DAM AT ROCK ISLAND ARSENAL. *Journal of the Western Society of Engineers* (Chicago), June, 1897.
- HEMET DAM, California. Paper read by J. D. Schuyler before the Technical Society of the Pacific Coast and published in the *Journal of the Association of Engineering Societies* for September, 1897. Abstract in *Engineering News* of March 24, 1898.
- MUCHKUNDI CONCRETE DAM, India. *The Engineer* (London), October 22, 1897.
- LÉVY, MAURICE. Note sur les diverses manières d'appliquer la règle du trapèze au calcul de la stabilité des barrages en maçonnerie. *Annales des Ponts et Chaussées*, 4. Trimestre, 1897.
- SWEETWATER DAM, California. *Repair and Extension*. *Engineering Record*, March 12, 1898.
- LÉVY, MAURICE. Sur la légitimité de la règle dite du trapèze dans l'étude de la résistance des barrages en maçonnerie. *Comptes Rendus de l'Académie des Sciences*, Paris, Mai 2, 1898.
- BARBET. Note sur le calcul des barrages de réservoirs en maçonnerie. *Annales des Ponts et Chaussées*, 2. Trimestre, 1898.
- LÉVY, MAURICE. Sur l'équilibre élastique d'un barrage en maçonnerie à section triangulaire. *Comptes Rendus de l'Académie des Sciences*, Paris, 4. Juillet, 1898.
- BELUBULA DAM (brick and concrete with buttresses), New South Wales. *Engineering News*, September, 1898.
- SCHUYLER, J. D. *The Failure of the Lynx Creek Masonry Dam, near Prescott, Arizona*. *Engineering News*, June 9, 1898.
- CLAVENAD. *Mémoire sur la stabilité, les mouvements, la rupture des massifs en général*. *Annales des Ponts et Chaussées*, 1. Semestre, 1887.
- HUBERT VISCHER and LUTHER WAGONER. On the Strains in Curved Masonry Dams. *Trans. Technical Society of the Pacific Coast*, vol. 6, December, 1889.
- BARBET, L. Note sur les conditions de résistance des barrages de réservoirs en maçonnerie. *Annales des Ponts et Chaussées*, 1. Trimestre, 1899.
- INDIAN RIVER DAM, New York. *Engineering News*, May 18, 1899.
- LAGRANGE DAM, California. *Trans. Am. Inst. of Mining Engineers*, September, 1899.
- EARTH BACKING FOR MASONRY DAMS. *Engineering Record*, December 23, 1899.
- ALARCO, J. M. *The Bear Valley Dam as an Arch*. *The Technograph*, University of Illinois, Champaign, Ill., No. 14, 1899-1900.
- TESTS OF AN ELASTIC MODEL OF A DAM. *Trans. of the Association of Civil Engineers of Cornell University*, Ithaca, New York, 1900.
- ZIEGLER, P. *Der Thalsperrenbau, nebst einer Beschreibung ausgeführter Thalsperren*. Berlin, 1900.
- FAILURE OF AUSTIN DAM, Texas. *Engineering News and Engineering Record* for 1900; also *Scientific American*, April 28, 1900.
- GOWEN, CHARLES S. *The Foundations of the New Croton Dam*. *Trans. Am. Soc. C. E.*, June, 1900. *The Changes at the New Croton Dam*. *Trans. Am. Soc. C. E.*, June, 1906.
- SCHUYLER, J. D. *Reservoirs for Irrigation, Water-power and Domestic Water-supply*. New York, 1901, pp. 117 to 274.
- WACHUSETT DAM, Massachusetts. *Engineering Record*, September 8, 1900, April 5, 1902, March 5, 1904, and October 6, 1906; *Engineering News*, September 13, 1900; *Scientific Ameri-*

- can Supplement, December 15, 1900; Railroad Gazette (New York), vol. XXXIX, No. 5.
- RUFFIEUX, R. Étude sur la résistance des barrages en maçonnerie. Annales des Ponts et Chaussées, 1. Trimestre, 1901.
- CILLETTE, H. P. Coefficient of Friction in Dam Design and the Failure of the Austin Dam. Engineering News, May 30, 1901.
- MASONRY DAMS, built by Spring Brook Water Supply Company, Pennsylvania. Trans. of Association of Civil Engineers of Cornell University, 1901; Engineering Record, June 15, 1901.
- GREGORY, JOHN H. Formulas for Stability of Small Dams. Engineering Record, September 21, 1901.
- ASSUAN DAM, Sluice Gates. Scientific American, October 12, 1901.
- NEW CROTON DAM. Report of Experts recommending Changes of Plans, and Discussions thereon by other Engineers. Engineering News, November 28, December 26, 1901, January 9 and 16, 1902.
- ASSUAN DAM, Egypt. The Nile Reservoir Dam at Assuan, by W. Willcocks, C.M.G., M. Inst. C. E., London, 1901; The Engineer (London), Dec. 12, 19, and 26, 1902; Engineering (London), Dec. 12, 1902; and Paper by Maurice Fitzmaurice, C.M.G., B.A.I., in Proc. Inst. C. E. for January, 1903.
- RAMISCH, G. Beitrag zur Dimensionierung der Thalsperrmauern. Zeitschrift des Oesterreichischen Ingenieur und Architekten Vereines, April 4, 1902.
- LAUCHENSEE DAM, Germany. Engineering Record, August 30, 1902.
- CADART, G. Barrages à parements rectilignes. Annales des Ponts et Chaussées, 3. Trimestre, 1902.
- DILLMAN, G. L. A proposed new type of masonry dams. Trans. Am. Soc. C. E., December, 1902.
- URFT DAM, Germany. Deutsche Bauzeitung (Berlin), March 14 and 21, 1903; Engineering News, July 16, 1903.
- WIGWAM DAM, Connecticut. Engineering News, May 7, 1903.
- BETWA DAM, India. Engineering News, June 4, 1903.
- SPIER FALLS DAM, New York. Engineering News, June 18, 1903.
- ITHACA DAM, New York. Engineering Record, July 18, 1903; Trans. Amer. Soc. C. E., December, 1904.
- BOONTON DAM, New Jersey. Engineering Record, August 8, 1903.
- WISNER, G. Y. The Correct Design and Stability of High Masonry Dams. Engineering News, October 1, 1903. See, also, Report made to F. H. Newell, Chief Engineer, in Engineering News, August 10, 1905.
- LAKE CHEESMAN DAM, Colorado. Engineering Record, October 24, 1903; Trans. Am. Soc. C. E., December, 1904; and Proc. American Water Works Association for 1906, p. 453.
- CONCRETE-STEEL DAMS: at Theresa, N. Y., Engineering News, Nov. 5, 1903; at Schuylerville, N. Y., Engineering News, April 27, 1905; at Danville, Ky., Engineering Record, Feb. 15, 1902; at Fenelon Falls, Ont., Engineering News, Feb. 9, 1905; at Huntington, Penn., Engineering Record, Dec. 22, 1906.
- AVIGNONET DAM. Schweizerische Bauzeitung, December 19, 26, 1903.
- BAROSSA DAM, Australia. Engineering News, April 7, 1904; Scientific American, April 1, 1905.
- CROCKER, F. W. Formulas for High Masonry Dams. California Journal of Technology, September, 1904.
- L. W. ATCHERLEY and KARL PEARSON. Some Disregarded Points in the Stability of Masonry Dams. Published in Draper's Company Research Memoirs, Technical Series II., London, 1904.
- CATARACT DAM, Australia. Engineering Record, Nov. 5, 1904, and April 20, 1907; Engineering News, December 6, 1906.
- ROOSEVELT DAM, Arizona. Engineering News, January 12, 1905; Engineering Record, October 14, 1905; Scientific American, December 16, 1905.
- SOLINGEN DAMS, Prussia. Génie Civil, February 25, 1905.
- UNWIN, Prof. W. C. On the Theory of Masonry Dams. Engineering (London), April 21, May 12, June 30, 1905.
- CHEYENNE DAM, Wyoming, for Granite Springs Reservoir. Engineering Record, June 24, 1905; Engineering News, June 29, 1905.
- PEARSON, Prof. KARL. On the Stability of Masonry Dams. Engineering (London), July 14, 1903.
- J. S. WILSON and W. GORE. Stresses in Dams. Engineering (London), August 4, 1905.
- STUPECKY, F. Zur Ermittlung von Kantenpressungen bei Sperrmauern. Oesterreichische Wochenschrift für den Oeffentlichen Baudienst, August 19, 1905.

- GALLIOT. Consolidation du barrage de Grosbois. Annales des Ponts et Chaussées, 3. Trimestre, 1905.
- AM ENDE, MAX. Notes on Stresses in Masonry Dams. Engineering (London), December 8, 1905.
- BELLET, H. Étude sur les barrages en maçonnerie et murs de réservoirs. La Houille Blanche, Lyon, France, 1905 et 1906.
- DAM FOR RESERVOIR OF PORT ELIZABETH, South Africa. Engineering News, February 8, 1906.
- THE BURRAGA DAM, Australia. Engineering Record, March 10, 1906.
- CONCRETE-BLOCK DAM ON PEDLAR RIVER, Virginia. Engineering Record, May 12, 1906.
- CROSS RIVER DAM, New York Water Works. Engineering Record, June 16, 1906.
- NEW CROTON DAM. Scientific American, October 17, 1896, and January 20, 1900; Engineering News, October 4, 1906.
- BLACKBROOK DAM, England. Engineering Record, November 24, 1906.
- MERCEDES DAM, Durango, Mexico. Engineering News, November 1, 1906.
- WEGMANN, E. The Design of the New Croton Dam. Trans. Am. Soc. C. E., June, 1907.

## EARTH DAMS.

- BELOE, C. H. Construction of Catch-water Reservoirs. London, 1872. pp. 17-48.
- MILL RIVER DAM, Williamsburg, Massachusetts. Report on the failure of the dam. Trans. Am. Soc. C. E., vol. 3 (June, 1874), pp. 118-22.
- DAM at Worcester, Massachusetts. Report on the failure of the dam. Trans. Am. Soc. C. E., vol. 5 (June, 1876), pp. 244-50.
- HUMBER, W. A Comprehensive Treatise on the Water-supply of Cities and Towns. London, 1876. pp. 102-110.
- DE BEAUVÉ. Manuel de l'Ingénieur des Ponts et Chaussées. Paris, 1878.
- FANNING, J. T. A Practical Treatise on Hydraulic and Water-supply Engineering. New York, 1882. pp. 333-370.
- GRAVELL, DAVID. Reservoir Dams (of earth and masonry). Engineering (London), March 11 and 18, 1887; also, Scientific American Supplement, May 28, 1887.
- JACOB, A. The Designing and Construction of Storage Reservoirs. Revised by E. S. Gould. New York, 1888. pp. 51-137.
- SOUTH FORK DAM, near Johnstown, Pennsylvania. Report of a committee on the failure of the dam. Trans. Am. Soc. C. E., vol. 24 (June, 1891), p. 431.
- FOLLETT, W. W. Earthen vs. Masonry Dams. Paper read before the Denver Soc. C. E., December 8, 1891. (Discusses dams of earth, masonry, rock-fill, and timber.) Given in full in Engineering News, January 2 and 9, 1892, and in Engineering Record, May 14 and 28, 1892.
- SANTA FÉ DAM, of earth. 85 ft. high, 1000 ft. long. Engineering News, April 13, 1893.
- LE CONTE, L. J. High earthen dams for storage reservoirs. Paper read before the American Water-works Association. Engineering Record, Sept. 16, 1893, p. 257.
- TURNER, J. H. T., and BRIGHTMORE, A. W. The Principles of Water-works Engineering. London, 1893. pp. 183-208.
- EARTH DAM OF THE HONEY LAKE VALLEY, California. Engineering News, March 15, 1894.
- BURTON, W. K. The Water-supply of Towns. London, 1894. pp. 53-70.
- WILSON, H. M. Irrigation Engineering. New York, 1896; pp. 347 to 373.
- RESERVOIR DAMS WITH IRON SHEETING. Advantages they may possess. The Engineer (London), May 8, 1896.
- STRANGE, WM. L. Reservoirs with High Earthen Dams in Western India. Minutes of Proc. Inst. C. E., vol. 132, p. 130 (1897-98).
- FOX, WILLIAM. Reservoir Embankments, with Suggestions for Avoiding and Remedying Failures. Trans. Society of Engineers, London, March 7, 1898. For abstract of this Paper see Engineering Record, September 3, 1898.
- LIPPINCOTT, J. B. The Failure of the Snake Ravine Dam (made by the hydraulic process), California. Engineering News, October 20, 1898, p. 242.
- EARTHEN DAM FOR WATER-WORKS of Cambridge, Massachusetts. Engineering News, November 24, 1898, p. 324.
- CRYSTAL SPRINGS DAM, California. Scientific
- SCHUYLER, J. D. Reservoirs for Irrigation, Water-power, and Domestic Water-supply. New York, 1901; pp. 76 to 117 and 274 to 299. American, December 17, 1898.
- DRUID LAKE DAM, Baltimore. Engineering News, February 20, 1902.
- WACHUSETT NORTH DIKE, Massachusetts. Engineering News, May 8, 1902.

- HILL, W. R. Classified Review of Dam and Reservoir Failures in the United States. Paper of American Water-works Association, 1902; also, Engineering News, June 19, 1902; Engineering Record, September 27, 1902.
- TABEAUD DAM, California. Engineering News, July 10, 1902.
- SAN LEANDRO DAM, California. Engineering News, September 11, 1902.
- BAILLARGE, C. Dam Construction and Failures during the Last Thirty Years. Trans. Canadian Society of Civil Engineers, 1903.
- WACHUSETT SOUTH DIKE, Massachusetts. Engineering Record, August 20, 1904.
- EARTH AND CRIB DAM ON THE ANIMAS RIVER, Colorado. Engineering News, January 4, 1906.
- THE BELLE FOURCHE DAM, South Dakota. Engineering News, February 22, 1906; Engineering Record, March 3, 1906.
- TENANGO DAM NO. 1, Mexico. Construction by Sluicing. Engineering Record, June 9, 1906.
- THE TERRACE HYDRAULIC-FILL DAM, Colorado. Engineering Record, December 22, 1906.

## ROCK-FILL DAMS.

- WALNUT GROVE DAM, Arizona. Engineering News, October 20, 1888.
- OTAY ROCK-FILL DAM. Engineering Record, Sept. 28, 1895.
- WILSON, H. M. Irrigation Engineering. New York, 1906. pp. 373 to 379.
- HOWELL, L. B. The Pecos Valley Irrigation System. Describes rock-fill dams. Engineering News, September 17, 1896, p. 181.
- SCHUYLER, J. D., gives descriptions of rock-fill dams in the Western States in his report on "Reservoirs for Irrigation," published in the XVIIIth Annual Report of the U. S. Geological Survey (1896-97).
- RUSSELL, W. S. A Rock-fill Dam with Steel Heart-wall, at Otay, Cal. Engineering News, March 10, 1898, p. 157.
- LOWER OTAY ROCK-FILL DAM, California. Engineering News, March 10, 1898.
- CANYON FERRY DAM, Montana. Journal of the Association of Engineering Societies, May, 1898. Reconstruction of the dam, Engineering News, April 26, 1900.
- CASTLEWOOD ROCK-FILL DAM, Colorado. Engineering News, December 24, 1898, and May 19, 1900; Engineering and Mining Journal, February 9, 1899; Engineering Record, July 12, 1902.
- EAST CANYON CREEK ROCK-FILL DAM, Utah. Engineering Record, September 2, 1899; Engineering News, January 2, 1902.
- ROCK-FILL DAMS WITH METALLIC REINFORCEMENT. Génie Civil, October 21, 1899.
- SCHUYLER, J. D. Reservoirs for Irrigation, Water-power, and Domestic Water-supply. New York, 1901. pp. 1 to 76.
- FAILURE OF LAKE AVALON ROCK-FILL DAM, New Mexico. Engineering News, July 6, 1905.
- ALFRED DAM, Maine. Dry rubble, faced on water side with concrete. Engineering Record, March 3, 1906.

## TIMBER DAMS.

- JAMES LEFFEL & Co. The Construction of Mill-dams. 1874.
- GRAFF, F. Notes upon the early history of the employment of water-power for supplying Philadelphia with water, and the building and rebuilding of the dam at Fairmount. Proceedings Engineers' Club of Philadelphia, August, 1886, vol. 5, p. 372.
- HOLYOKE DAM. Paper by Clemens Herschel, Trans. Am. Soc. C. E. for 1886; see, also, Engineering News, May 13, 1897.
- CHITTENDEN, S. H. Dam across the Potomac River (partly of masonry, partly of crib-work). Trans. Am. Soc. C. E., vol. 18 (February, 1888).
- SMITH, E. F. Dam Building in Navigable and Other Streams. Proceedings of the Engineers' Club of Philadelphia, vol. 7 (August, 1888), p. 7.
- CROES, J. J. R. Lumber Dam in Pennsylvania. Engineering News, September 5, 1891, p. 205.
- PARKER, M. S. Black Eagle Falls Dam (crib-dam, 14 feet high). Trans. Am. Soc. C. E., vol. 27 (July, 1892), p. 56.
- SEWALL FALLS DAM across the Merrimac River, near Concord, N. H. Engineering News, April 19, 1894.
- PEARSONS, G. N. Dam at Bangor, Maine. Closing of the timber dam. Engineering News, July 26, 1894.



- HARDESTY, W. P. The Bear River Irrigation System, Utah. Describes a crib-dam 370 feet long and 17½ feet high. *Engineering News*, February 6, 1896, p. 83.
- BISHOP, W. J. The Lachine Rapids Power Plant, Montreal, P. Q. Describes masonry and crib dams. *Engineering News*, February 18, 1897, p. 98.
- TIMBER DAM for the Power Plant of Butte, Montana. *Engineering Record*, March 5, 1898, p. 301. For partial failure of this dam see *id.*, August 6, 1898, p. 203.
- TIMBER DAM ACROSS SOUTH YUBA RIVER, California. Mining and Scientific Press, San Francisco, February 8, 1896.
- CRIB-DAM ACROSS ROCK RIVER, Illinois. *Journal of the Association of Engineering Societies*, July, 1896.
- CRIB-DAM, Butte, Montana. *Engineering Record*, August 6, 1898, February 3, 1900; *Journal Association of Engineering Societies*, April, 1899.
- CHESUNCOOK TIMBER DAM, Maine. *Engineering Record*, July 16, 1904.

## STEEL DAMS.

- STEEL DAM at Ash Fork, Arizona. *Engineering News*, May 12, 1898; *Engineering Record*, April 9, 1898; *Journal of the Western Society of Engineers*, October, 1905.
- REDRIDGE STEEL DAM, Michigan. *Engineering News*, August 15, 1901; *Journal of the Western Society of Engineers*, October, 1905.

## MOVABLE DAMS.

*Memoirs and Notes in the Annales des Ponts et Chaussées.*

1839. CHANOINE. Mémoire sur le barrage d'Épineau. 1st Series, vol. 16, p. 238.
1841. THÉNARD *et al.* Barrages fixes à hausses mobiles exécutées sur la rivière de L'Isle. 2d Series, vol. 2, p. 45.
1843. CHANOINE ET POIRÉE. Échappements des barrages à fermettes mobiles. 2d Series, vol. 5, p. 241.
1845. LAVAL. Notice sur les travaux de perfectionnement de la navigation de la Saône, entre l'embouchure du canal du Rhone au Rhin et Lyon. 2d Series, vol. 9, p. 10.
1851. CHANOINE. Barrage Auto-Mobile. Mémoire sur la fusion des systèmes de MM. Poirée et Thénard. 3d Series, vol. 2, p. 133.
1853. CHRONIQUE. Barrage de Laneuville-le-Pont (Bear-trap dam on the Marne). 3d Series, vol. 6, p. 252.
1855. CHRONIQUE. Barrages mobiles de M. Chanoine. 3d Series, vol. 10, p. 97.
1859. CHANOINE. Mémoire sur les hausses mobiles et automobiles: construction du barrage de Conflans-sur-Seine et expériences faites à Conflans et à Combeton. 3d Series, vol. 18, p. 197.
1861. CHANOINE ET DE LAGRENÉ. Mémoire sur les barrages à hausses mobiles. 4th Series, vol. 2, p. 209.
1866. DE LAGRENÉ. Étude Comparative sur divers systèmes de barrages mobiles. 4th Series, vol. 11, p. 172.
1867. CAMBUZAT. Note sur les barrages mobiles du système Poirée et du système Chanoine qui fonctionnent simultanément, pour les éclusées de l'Yonne. 4th Series, vol. 13, p. 135.
1868. SAINT-YVES. Étude Comparative des divers systèmes de barrage mobiles. 4th Series, vol. 15, p. 282.
1868. DE LAGRENÉ. Observations relatives aux barrages mobiles. 4th Series, vol. 16, p. 50.
1868. CHANOINE ET DE LAGRENÉ. Mémoire sur la construction des douze barrages éclusées exécutés sur la haute Seine, entre Paris et Montereau. 4th Series, vol. 16, p. 479.
1868. MALÉZIEUSE. Notice sur le barrage construit en 1867, sur la Marne à Joinville (Seine). 4th Series, vol. 16, p. 482.
1870. SAINT-YVES. De l'emploi des barrages mobiles du système Poirée pour des retenues d'eau supérieur à 2 metres au-dessus de l'étiage. 4th Series, vol. 20, p. 425.
1873. CAMBUZAT. Substitution d'une navigation continue à l'aide des barrages mobiles à la navigation intermittente produite par les éclusées de l'Yonne sur la Seine et sur l'Yonne, entre Paris et Auxerre. 5th Series, vol. 5, p. 177.
1873. BOULÉ. Nouvelle Passe Navigable établie en 1870 dans le barrage de Port à l'Anglais. Hausses mobiles supportant une retenue de 4 metres. 5th Series, vol. 6, p. 98.
1873. REMISE. Barrage Mobile Automoteur. Système à presses hydrauliques de M. Girard. 5th Series, vol. 6, p. 360.
1874. DE LAFOSSE. Travaux d'embellissement de Vichy. Barrage mobile établi à Vichy sur l'Allier. 5th Series, vol. 7, p. 659.

1876. BOULÉ. Mémoire sur un nouveau système de barrage mobile fermé par des vannes et des fermettes. 5th Series, vol. 11, p. 320.
1881. LÉVY. Note sur la manœuvre des barrages Chanoines. 6th Series, vol. 1, p. 419.
1881. LAVOLLÉE. Note sur un système employé pour la manœuvre des aiguilles au déversoir de Port à l'Anglais. 6th Series, vol. 2, p. 221.
1883. LAVOLLÉE. Note sur les ouvrages mobiles des barrages de la Haute Seine. 6th Series, vol. 5, p. 622.

---

REPORTS OF THE CHIEF OF ENGINEERS U. S. A.

1876. Part II, p. 14. Report by Lieut. F. A. Mahan on the dam at Port à l'Anglais (France).
1879. P. 1339. Note on Curtain-dam of M. Caméré for Poses dam (France); p. 1338, La Mulatière Dam.
1880. Part II, p. 1753. La Mulatière Dam on the Saône at Lyons. Description of the new system of wickets adopted for this dam, by M. Pasqueau.
1884. Part III, p. 1731. Report on a proposed dam at Beattyville on the Kentucky River with bear-trap gates.
1889. Part III, p. 1869. Report of a Board of Engineers on the extension of the system of Movable Dams to the Ohio River.
1892. P. 2102. Report of Officers of the Corps of Engineers on the Dam on the Big Sandy River, near Louisa, Kentucky.
1897. P. 2534. Description of Lock and Movable Dam in the Big Sandy River, near Louisa, Kentucky, by Major Gregory.
1898. Part III, p. 2118. Improvement of the Great Kanawha River, West Virginia.
1898. Part III, p. 2143 and 2160. Improvement of Big Sandy River, West Virginia and Kentucky.
1898. Part VI, p. 3546. Construction and Operation of Model of Movable Dam for Osage River (Chittenden).
1899. Part III, p. 2185. Report on Lake Winnibigoshish Dam, etc.
1899. Part III, p. 2505. Operating and Care of Lock and Dam in Big Sandy River, West Virginia and Kentucky.
1900. Part IV, p. 2358. Data on Cost of Movable Dams.
1900. Part V, p. 3146. Movable Dams in Ohio River.
1900. Part V, p. 3257. Construction of Locks and Dams at Herr Island and at Springdale, Allegheny River.
1900. Part V p. 3325. Operating and Care of Locks and Dams on Kanawha River, West Virginia.
1900. Part V, p. 3353. Operating and Care of Lock and Dam in Big Sandy River, West Virginia and Kentucky.
1900. Part V, p. 3482. Operating and Care of Louisville and Portland Canal, Louisville, Kentucky.
1900. Part VI, p. 4327. Item 8. A-frame Dam for Cascade Canal, Columbia River, Oregon.
1901. Part III, p. 2314. Reconstruction of Lake Winnibigoshish Dam.
1901. Part IV, p. 2659. Movable Dams in Ohio River.
1901. Part IV, p. 2768. Proposed Movable Dams for Big Sandy River, West Virginia and Kentucky.
1902. Part II, p. 1667. Improvement of Mississippi River between Minneapolis and St. Paul.
1902. Part III, p. 2500. The Chanoine Dam as adapted to Improvement of Congaree River, South Carolina.
1903. Part II, p. 1683. Operating and Care of Herr Island Dam (No. 1), Allegheny River.
1903. Part II, p. 1693. Movable Dams in Ohio River.
1904. Part II, p. 2232. Improvement of Mississippi River between St. Paul and Minneapolis, Minnesota.
1904. Part II, p. 2239. Reconstruction of Pokegama Falls Dam.
1904. Part III, p. 2527. Improvement of Allegheny River, Pennsylvania
1904. Part III, p. 2707. Improvement of Ohio River.
1905. Part II, p. 1842. Operating and care of locks and dams on Ohio River.
1905. Part II, p. 1858. Operating and care of locks and dams on Allegheny River, Pennsylvania
1905. Part II, p. 1912. Improvement of Kentucky River, Kentucky.
1906. Part II, see pp. 1589, 1610, and 1650.

- DE LAGRENÉ, H. *Cours de Navigation Intérieur*. Paris, 1873. Vol. 3, pp. 174-359.
- WM. WATSON. River Improvements in France, including a description of Poirée's system of Movable Dams. *Van Nostrand's Eclectic Engineering Magazine*, vol. 18 (1878), p. 339.
- WM. WATSON. River Improvements in France, including a description of Chanoine's system of Falling Gates. *Van Nostrand's Eclectic Engineering Magazine*, vol. 18 (1878), p. 458.
- VERNON-HARCOURT, L. F. The Progress of Public Works Engineering. *Van Nostrand's Engineering Magazine* (January, 1880), vol. 22, p. 11.
- VERNON-HARCOURT, L. F. Fixed and Movable Weirs. *Minutes of Proceedings Inst. C. E.*, 1880, vol. 60, p. 24.
- BUCKLEY, B. B. Movable Dams in Indian Weirs. *Minutes of Proceedings Inst. C. E.*, 1880, vol. 60, p. 43.
- WISWALL'S Tilting Shutter-weir. *The Engineer*, September 1, 1882.
- ANNUAL REPORT of the Commissioner of Dams and Reservoirs in the State of Rhode Island, U. S. A., for 1885-1890.
- VERNON-HARCOURT, L. F. The River Seine. *Minutes of Proceedings Inst. C. E.*, 1886, vol. 84, p. 210.
- VERNON-HARCOURT, L. F. La canalisation des rivières—barrage mobile. *International Congress of Paris*, 1889.
- VERNON-HARCOURT, L. F. Some Canal, River, and other Works in France, Belgium, and Germany. *Minutes of Proceedings Inst. C. E.*, 1889, vol. 96, p. 186.
- WATSON, Professor W. Report to the U. S. Government on Civil Engineering, Public Works, and Architecture at the Paris Universal Exposition of 1889.
- POCHET'S MOVABLE DAM. *Scientific American Supplement*, May 24, 1890.
- CANALIZATION OF THE SEINE (describes Poses Dam). *Scientific American Supplement*, July 12, 1890.
- THE DAVIS ISLAND DAM on the Ohio River, Pittsburg, Pennsylvania. *Scientific American Supplement*, August 1, 1891.
- JONES, Major W. A. Dam and Weirs. Describes a modified bear-trap gate at Sandy Lake, Minn. *Engineering Record*, February 2, 1895.
- CHITTENDEN, Lieut. H. M. American Types of Movable Dams and their Development. *Engineering News*, February 7, 1895.
- AMERICAN HYDRAULIC GATES, WEIRS, AND MOVABLE DAMS. *Journal of the Association of Engineering Societies*, June, 1896. (A series of articles by different writers.)
- STICKNEY, AMOS. Lifting Dam for Navigable Pass of Dam No. 6, Ohio River. *Journal of the Association of Engineering Societies*, June, 1896.
- BEAR-TRAP GATES IN AMERICAN DAMS. *Journal of the Association of Engineering Societies*, June, 1896.
- THOMAS, B. F. A Design for a Movable Dam. *Journal of the Association of Engineering Societies*, June, 1896.
- THE FOUNDATIONS OF THE HERR ISLAND LOCK AND DAM, near Pittsburg, Pennsylvania. *Engineering News*, August 20, 1896, p. 127.
- LOCKS AND DAMS ON THE GREAT KANAWHA RIVER. *Engineering News*, August 13, 1896, p. 98, and December 31, 1896, p. 426.
- VERNON-HARCOURT, L. F. Rivers and Canals. London, 1896. Vol. 1, pp. 121-148.
- CLAISE. Difficultés que l'on rencontre à maintenir à la retenue réglementaire les barrages à aiguilles de la Meuse Ardennaise et note sur un système de vanne étudié par M. Baudisson. *Annales des Ponts et Chaussées*, 2. Trimestre, 1897. See, also, *Oesterreichische Monatsschrift für den Oeffentlichen Baudienst*, Wien, November, 1897.
- ROLLING SHUTTERS IN MOVABLE DAMS. *Génie Civil*, May 1, 1897.
- THE MARSHALL AUTOMATIC MOVABLE DAM. *Engineering News*, May 26, 1898, p. 343.
- THE MANAGEMENT OF NON-PARALLEL MOTION and Deficient Operating Head in Bear-trap Dams by Auxiliary Constructions. *Engineering News*, May 26, 1898, p. 338.
- BEAR-TRAP DAM FOR REGULATING WORKS, Chicago Drainage Canal. *Engineering News*, March 24 and May 26, 1898.
- NEEDLE-DAM ON BIG SANDY RIVER, Kentucky. *Trans. Am. Soc. C. E.*, June, 1898; *Génie Civil*, May 14, 1898; *Engineering News*, July 7, 1898.
- THOMAS, B. F. Movable Dams. *Trans. Am. Soc. C. E.*, June, 1898.
- CHITTENDEN DRUM DAM on Osage River. *Engineering Record*, September 16, 1899.
- RECONSTRUCTION OF THE LAKE WINNIBIGOSHISH DAM. *Engineering Record*, September 13, 1902.



## INDEX.

	PAGE		PAGE
Adams, J. W. ....	155	Bogart, John. ....	143
A-frame dams .....	323, 365	Bog Brook Reservoir. ....	145
Ahern, Jeremiah .....	207	Bonanno, G. ....	386
Aird & Co., Sir John .....	109	Boonton Dam .....	196
Algiers, dams in .....	94	Bosé, C. M. ....	220
Ali, Viceroy Mehemet .....	101, 103	Bosmelea Dam .....	63
Alicante Dam .....	54	Bostaph, W. M. ....	278
Allen, C. P. ....	198	Boulé Gates. ....	314
Almanza Dam. ....	54	Boulé Gates on the Moskowa River. ....	315
Ambursen Hydraulic Construction Co. ....	210, 219, 220	Boulé, M. ....	314
Amercian dams. ....	128	Bouvier, M. ....	5, 6, 16, 69
American Wood Board Company .....	219	profile on principle of .....	31
Arch, dam acting as a horizontal .....	46	Bouzey Dam, description .....	71
Ash Fork Dam .....	294	failure of .....	71
Ashti Dam .....	234	Boyd's Corners Dam .....	128
Assiout Dam .....	115	Brickel, P. S. A. ....	258
Assuan Dam .....	104	Bridgeport Dam. ....	128
Atcherley, L. W.:		Brunot Gate .....	348
conclusions from experiments. ....	10	Brushwood Dams. ....	281
models of dam .....	9	Burbank, Geo. B. ....	146
paper on masonry dams .....	8	Butte City Dam .....	144
Avignonet Dam .....	74	Butterfly Dam. ....	362
		By-wash for reservoirs. ....	227
Babcock, E. S. ....	220	Cagliari Dam .....	79
Bainbridge, F. H. ....	294, 297	Cagliari, lime of .....	79
Baker, Sir Benjamin .....	104, 109	Cairns, R. A. ....	130
Baldwin, E. H. ....	204	Calculation of Profile No. 6 .....	403
Ban Dam .....	70	Caldwell, Sir James. ....	120
Barossa Dam .....	126	Caméré's Curtain-dam .....	316
Barton, E. H. ....	141	Canilization of rivers .....	301
Bassell, Burr .....	237, 239, 240, 242	Canyon Ferry Dam .....	293
Basseville Poirée Needle-dam .....	302	Carlier, M. ....	73
Bear-trap dams (gates) .....	344	Carr, Albert. ....	264
Bear Valley Dam .....	135	Carstanjen, Max. ....	358
Beauve, M. de, graphical method of .....	6	Case, E. W. ....	263
Beaver, Movable Dam .....	364	Carro Gate .....	347
Beetaloo Dam .....	121	Castlewood rock-fill dam .....	275
Bélangier, M. ....	14	Cataract Dam .....	127
Belle Fourche Dam .....	245	Ceylon, ancient dams in .....	233
Bellet, H. ....	78	Chabot, Anthony, .....	237, 238
Beloe, Chas. H. ....	235	Chanoine Wicket-dams. ....	327
Belubula Dam .....	53	Charlottenburg Drum-dam. ....	340
Betwa Dam .....	119	Chartrain Dam. ....	72
Beznau Dam .....	357	Chatsworth Park rock-fill dam. ....	273
Bhatgur Dam .....	118	Chazilly Dam. ....	64
Bidaut, M. ....	85	Cher Dam. ....	78
Big Sandy River Needle-dam .....	309	Chesbrough, E. S. ....	155
Blackwell, F. O. ....	265	Chittenden Drum-dam. ....	341
Blanc, M. ....	5	Church, B. S. ....	155
Boardman, W. F. ....	239		

	PAGE		PAGE
Clavenad's method.....	7	Dams in America.....	128
Clerk, W. ....	116	in Asia and Australasia.....	116
Coleman, Breuchaud & Coleman.....	184	in Brazil.....	265
Coleman, Ryan & Brown.....	184	in Egypt.....	101
Coleman, Jas. S. ....	184	in France.....	63
Colorado Dam.....	142	in Mexico.....	264
Columbia Timber Dam.....	289	in Spain.....	54
Comparison of profile types.....	42	made by the Hydraulic Process.....	248
of de Sazilly's and Delocre's type.....	3	of Reinforced Concrete.....	210
of theoretical and logarithmic type.....	32	various European.....	79
Component, vertical, of water pressure included.....	29	Davies, Chester B.....	145
neglected in calculations.....	5, 20	Davis, A. P. ....	204, 207, 246
Components of inclined force.....	15	Davis, J. P.....	155, 158, 194
Conditions assumed by Rankine.....	4	Davis and Weber Counties Canal Co. ....	278
by de Sazilly.....	1	Deacon, G. F.....	89
for practical profiles.....	34	Debrousse, M... ..	95
for theoretical profiles.....	19	Del Gasco Dam.....	59
Confians Movable Dam.....	327	Delestrac, M. ....	77
Construction of dams.....	46	Delocre:	
Conte-Grandchamps.....	65	area of type of.....	3, 42
Cook, F. S. ....	209	Habra Dam designed by method of.....	94
Cooley, L. E. ....	199	method of.....	2, 3
Core-walls of masonry.....	225	studies for Furens Dam by.....	65
Cornell Site, for New Croton Dam.....	162	theory of curved dams by.....	46
Cotatay Dam.....	77	type of.....	3
Counterforts in Gros-Bois Dam.....	64	Desfontaines Drum-dam.....	338
in Pont Dam.....	72	Dillman, Geo. L....	53
in Gorzente Dam.....	80	Djidionia Dam.....	99
Courbeton Movable Dam.....	327	Drains:	
Coventry, W. B. ....	6	in Tytam Dam.....	124
Crane Valley Dam.....	255	in Vyrnwy Dam.....	88
Craven, Alfred.....	152	to prevent upward pressure of water.....	49
Crib-dams.....	283	Druid Lake Dam.....	236
Croes, J. J. R. ....	128, 158, 163, 243	Drum-dams on the Main.....	340
Cross River Dam.....	208	Du Bois Gate.....	347
Croton dam, new.....	162	Dun, James.....	297
dam, oid.....	153	Earthen dams:	
Croton Falls Dam.....	209	ancient.....	233
Crowe, H. S. ....	141	construction.....	231
Crowell, F. Foster.....	297	culvert for pipes.....	228
Crugnola, Gaetano:		failures.....	246
areas in type of.....	42	gate-house.....	229
eccentricity of line of pressure in type of.....	38	general plans.....	221
memoir on rupture of Habra Dam by.....	96	dams, high.....	233
profile type of.....	6	dams in India.....	234
superelevation of top of dam recommended by ..	36	masonry core-walls.....	225
top width of dam recommended by.....	36	materials for constructing.....	222
Curtain-dam invented by M. Caméré.....	316	outlet and waste pipes.....	228
Curved plan for dams.....	46	profiles.....	222
Cut-stone facings for rubble or concrete dams.....	49	puddle core.....	223
masonry for building a dam.....	49	siphon outlet-pipes.....	229
Cuvinot Drum-dam.....	340	tunnel for pipes.....	229
Cyclopean Masonry.....	87	valve-tower.....	229
Dale Dyke Dam, failure of.....	246	waste-weir.....	225
Damietta Dam.....	101	East Canyon Dam.....	277
Dams, ancient.....	233	Echapre Dam.....	76
Dams, buttressed and arched.....	53	Einsiedel Dam.....	90
failures of earthen.....	246	Ekruk Dam.....	234
for New York Water Works.....	242	Elasticity of masonry in Gros-Bois Dam.....	63
in Algiers.....	94	Elche Dam.....	57

INDEX.

417

	PAGE		PAGE
Escondido rock-fill dam .....	266	Hamiz Dam .....	100
Evans, S. E. ....	196	Harlacher, Prof. A. R.:	
Factor of safety against overturning .....	19	areas of type of.....	42
Failure of Bouzey Dam .....	72	eccentricity of line of pressure in type of.....	38
of Colorado Dam .....	143	profile obtained by trail calculations by .....	6
of del Gasco Dam .....	59	projected Komotan Dam.....	93
of earthen dams in Algiers .....	94	Hardy, Geo. F.....	219
of Habra Dam .....	95, 96	Harper, J. B. ....	260
of Puentes Dam .....	58	Harrison, Chas. L.....	198, 199
Fanning, J. T. ....	00	Harrison, Edlon W.....	196, 197
Feburier, M. ....	95	Hauser Lake Dam.....	298
Felix Timber Dam.....	289	Helena Power Transmission Co. ....	298
Fife, Col. R. E. ....	116, 118	Hemmet Dam.....	142
Fife Lake.....	116	Hétier's method.....	7
Filer, W. G. ....	258	Hijar Dams.....	61
Fitzmaurice, Maurice .....	104	Hilgard, Prof. K. E.....	357, 361
Flinn, Alfred D.....	194	Hill, A. ....	119
Floating bodies, resistance to.....	20, 34	Hill, Louis C. ....	204
Folsom Dam.....	141	Hill, Wm. R.....	184, 243
Fortier, Prof. Samuel.....	278	Holyoke Dam .....	290
Frame-dams .....	301	Honness, Geo. G.....	197, 209
Framed timber dams.....	286	Howells, J. M. ....	254, 255
Frames for needle-dams .....	305	Hull and Palmer .....	129
Francis, J. B.....	155, 226	Humber, William.....	235
French dams .....	63	Hurter for wicket-dam .....	327
Frizzell, Jos.....	143, 144	Hyde, F. S.....	254, 264
Fteley, Alphonse.....	152, 155, 184, 194, 244	Hydraulic Process of making dams .....	248
Fuller, Wm. B. ....	197		
Furens Dam .....	65	Idaho rock-fill dam .....	274
		Ile Brûlée movable dam .....	336
Gaffy & Keefe.....	203	Improvements in needle-dams.....	306
Gasco, Dam del .....	59	India, ancient dams in .....	233
Geddes & Seerie Stone Co. ....	207	modern dams in.....	234
Geelong Dam .....	122	Indian River Dam.....	184
German Dams.....	89	Intze, Prof. Otto .....	92
Gileppe Dam. ....	81	Ithaca Dam.....	200
Girard Gate .....	348	Water Works Company.....	202
Shutter-dam.....	336		
Glomel Dam .....	63	Jackson, J. F.....	297, 298
Goldmark, Henry.....	53	Janicki, movable dams built by M. ....	315
Gozente Dam .....	80	Jaycox, T. W.....	263
Gouffre d'Enfer, dam of .....	65	Jersey City Water Supply Company .....	197, 198
Gowen, Chas. S.....	152, 184, 244	Johnstown, Failure of Dam near .....	247
Græff, M. de.....	3, 28, 65	Jones, R. M.....	279
Gran Cheurfas Dam .....	99	Juniata Dam.....	219
Granite Springs Dam .....	202	Juniata Hydro-Electric Company.....	220
Graphical method applied to check Practical Profile			
No. 3 .....	386	Kaiser Franz Joseph Dam ( <i>see</i> Komotan Dam) ..	
Greathed, Col.....	119	Kanawha River Dams.....	364
Great Kanawha River wicket-dams .....	332	Kellogg, H. Clay .....	259
Greene, Geo. S. ....	128	Kernsville timber dam .....	289
Gros-Bois Dam:		Kleccan Dam .....	363
description of.....	63	Komotau Dam .....	92
counterforts in.....	64	Krantz, J. B.:	
elasticity of masonry in .....	63	areas of type of.....	42
Guillemain, M.....	17	Chief Engineer of Ternay Dam .....	69
Guillemain's Method .....	6	method recommended for curved dams by ...	48
		profile type of.....	6
Habra Dam, description .....	94	superelevation of top of dam recommended by ..	36
failure of.....	96	top width of dam recommended by.....	36
Hagneck Dam.....	357	weight of masonry assumed by.....	29

	PAGE		PAGE
Kreuter, Franz.....	6	Mexican Light & Power Co.....	264
Kummer's escape device for needle-dams.....	308	Mills, Hiram F.....	194
Lagolungo Dam.....	80	Minard, M.....	97
Lagrange Dam.....	140	Miodeix Dam.....	75
Lake Cheesman Dam.....	198	Miowitz Dam.....	364
Lake Francis Dam.....	253	Molesworth gives empirical formulæ.....	6
La Mesa Dam.....	251	Moncrieff, A. B.....	122
La Mulatière Dam.....	331	Moncrieff, Sir Colin Scott.....	103
Lampy Dam.....	63	Montgolfier, M.....	65
Landish, Ernst.....	93	Morena Dam.....	277
Lang Gate.....	349	Morer, Mr. José.....	61
Lavignina Dam.....	80	Mouche Dam.....	73
Leakage, means of preventing.....	49	Mongel Bey.....	101
Libschitz Dam.....	364	Movable dams, recent.....	363
Limits of pressure		Murtaugh, M. M.....	265
adopted by early French writers.....	20	Muscle Shoals Canal Gates.....	349
Limits of pressure:		Narrow valley, curved dam advisable for.....	46
adapted for practical profiles.....	41	Necaxa Dam.....	265
tendency to higher.....	20	Needle-dams.....	301
Line of pressure:		Needle-dams in Belgium.....	307
definition of a.....	2	Needles for dams.....	304
extreme position of.....	2	Neuville Bear-trap Dam.....	346
in a dam acting as an arch.....	47	New Croton Dam.....	162
Lines of pressure:		New Hartford Timber Dam.....	287
eccentricity in various profiles of.....	38	Newell, F. H.....	46, 204, 207, 246
limited to centre third of profile.....	4, 19	Newton, Isaac.....	155
necessity of limiting position of.....	28	Nijjar Dam.....	60
Log-dams.....	282	Nile Dams.....	101
Lower Otay rock-fill dam.....	270	Noble, Alfred.....	199
Lozoya Dam.....	60	North Dike of Wachusett Reservoir.....	244
Lueger, Dr. Otto.....	93	Ohio River Dams.....	364
Mackenzie, A. T.....	121	Ohio River Wicket-dams.....	333
Malloy, James & Co.....	209	Old dams of masonry.....	1, 54
Marshall Gate.....	350	Ondenon Dam.....	77
Martin, Robert K.....	237	Orange, James.....	124
Masonry dams:		Ornam & Crook.....	246
back filling.....	50	Outlet-fountain.....	231
drainage system.....	49	Overflow-weir.....	225
failures of.....	58, 59, 72, 143	Overturning, safety against.....	19
foundation excavation.....	48	Parabolic curves for faces of Gran Cheurfas Dam....	100
gate-houses.....	50	Parker Gate.....	349
masonry.....	49	Parsons, Chas. F.....	196
sluice-gates.....	51	Parsons, Wm. Barclay.....	196
Masonry for dam:		Pas du Riot Dam.....	69
considered rigid and homogeneous.....	12	Pasqueau hurter.....	330
construction.....	46	Patch, Walter W.....	246
effect of weight of.....	29	Pearson, F. S.....	264, 265
of concrete.....	49	Pearson, Prof. Karl.....	8
of cut-stone.....	49	Pecos Valley Rock-fill Dams.....	274
of rubble.....	49	Pelletreau, M.....	6
May, C. R.....	109	method of.....	6
McArthur Brothers.....	194	opinion about curved dams of.....	47
McArthur Brothers Company and Winston & Co....	209	Pendergast & Clarkson.....	208
McCulloh, Walter.....	146	Pennycuick, Col.....	121
Meer Allum Dam.....	53, 124	Periar Dam.....	120
Merrill, Col. Wm. E.....	364	Pike's Peak Water Company's Dam.....	278
Merrill Dam.....	364	Pilarçitos Dam.....	239
Méry, M.....	14	Pile-dams.....	284
Metropolitan Water Work of Boston.....	244		



PAGE		PAGE
	Pile foundation for Puentes Dam.....	58
	Plank-dams.....	284
	Plymouth Timber Dam.....	288
	Pochet, Léon.....	95
	Poirée needle-dam.....	301
	Polygonal faces for masonry dam:	
	of theoretical type.....	24
	recommended by Delocre.....	3
	de Sazilly's objections to.....	2
	Pont Dam.....	72
	Pontoon-dam invented by M. Krantz.....	334
	Poona Dam.....	116
	Port Mort Curtain-dam.....	324
	Port Villez Curtain-dam.....	319
	Poses Curtain-dam.....	320
	Power-house in concrete-steel dam.....	213
	Pozzolona of Rome, used in Cagliari Dam.....	79
	Pressure:	
	distribution in a wall.....	12
	effects of high limits of.....	28
	in Almanza Dam.....	28, 54
	in dam acting as a horizontal arch.....	47
	limits of, recommended by Rankine.....	4
	limits of, adopted.....	41
	line of.....	2
	maximum, in Practicla Types 1 and 2.....	40
	maximum, reservoir empty.....	2
	maximum, reservoir full.....	2
	of water against a curved dam.....	47
	uniformly distributed.....	13
	uniformly varying.....	13
	Princeton Dam.....	53
	Profile of Masonry dam:	
	designed by Crugnola.....	6
	Delocre.....	3
	Harlacher.....	6
	Krantz.....	6
	Rankine.....	4
	de Sazilly.....	2
	logarithmic.....	5
	of equal resistance.....	2
	on Bouvier's principle.....	31
	practical.....	II, 34
	stepped.....	2, 3
	theoretical.....	10
	theoretical, compared with Rankine's.....	32
	with polygonal faces.....	10, 24
	Puddle-core for earth-dams.....	223
	Puentes Dam.....	57
	Quaker Bridge Dam (proposed):	
	description of.....	154
	project abandoned.....	162
	Qualey, Jos. S. & Co.....	198
	Quantin, J. H.....	207
	Rafter, Geo. W.....	185
	Rankine, Prof. W. J. M.:	
	areas of type of.....	42
	eccentricity of line of pressure in type of.....	38
	logarithmic profile of.....	5
	Rankine, Prof. W. J. M.:	
	method for curved dams of.....	48
	method of.....	4, 5
	theoretical profile compared with type of.....	32
	Toolsee Dam built according to type of.....	124
	Beetaloo Dam built according to type of.....	122
	Reaction of the foundation.....	12
	Redridge Dam.....	297
	Reinforced concrete dams.....	210
	Reinold, E. K., sluice-gates designed by.....	119
	Remscheid Dam.....	90
	Resistance to overturning.....	19
	Resistance to sliding.....	19
	Resultant of forces acting on a dam.....	12
	Reuss, M. G.....	77
	Richardson, Thos. F.....	194
	Rickey, James W.....	358
	Ridgway, Robert.....	152
	Robinson, A. F.....	297
	Rochetaillée, Dam of.....	65
	Rock-fill dams.....	266
	Rogers, F. B.....	184
	Rolling dams.....	358
	Roosevelt Dam.....	203
	Rosetta Dam.....	101
	Rubin, V.....	363
	Rundall, Gen. J. H.....	103
	Ryves, Major.....	120
	Saint Etienne, dam of.....	65
	San Andres Dam.....	239
	San Joaquin Electric Company.....	255
	San Leandro Dam.....	237
	San Mateo Dam.....	130
	Sanders, W. H.....	204
	Santa Fé Pacific Ry.....	294
	São Tramway, Light & Power Co.....	265
	Sauviat Dam ( <i>see</i> Miodeix Dam).....	
	Savage, H. N.....	207
	Sazilly, M. de:	
	areas of type of.....	42
	method of.....	I, 2
	type of.....	3
	Schulze, Oscar.....	125
	Schuyler, J. D. 136, 238, 248, 254, 255, 258, 259, 260, 263 264, 266	
	Schuylerville Dam.....	219
	Schuylkill River Timber Dams.....	288
	Schaeinfurt Rolling Dams.....	361
	Scouring-galleries ( <i>see</i> descriptions of Spanish Dams)	
	Scouring-pipes.....	228
	Sears, Walter H.....	184, 209
	Separating-weir.....	227
	Settons Dam.....	64
	Seymour, J. J.....	255
	Shaler, Ira A.....	157
	Shirreff, Reuben.....	194
	Shoshone Dam.....	207
	Shunk, Wm. F.....	158, 162
	Shutter-dams.....	325
	Shutter-gates, early.....	325

	PAGE		PAGE
Sioule Dam.....	75	Tripping-bar for wicket-dam .....	330
Sliding, resistance to.....	19	Troja Dam.....	363
Smith, C. E.....	184	Tucker & Vinton.....	202, 219
Smith, C. W.....	204	Tulloch, Major.....	116
Smith, E. F.....	243	Turloch Dam ( <i>see</i> Lagrange Dam) .....	
Smith, J. Waldo.....	170, 184, 197	Turdine Dam.....	76
Snake River Dams.....	258	Twin Falls Land & Water Co.....	258
Sodom Dam.....	145	Tyler Dam .....	248
Southern California Mountain Water Co.....	277	Types:	
Spanish dams.....	54	comparison of de Sazilly's and Delocre's.....	3
Specific gravity of masonry:		comparison of various.....	42
assumed by various writers .....	29	Practical, 1 and 2.....	39
of Ternay Dam.....	70	Theoretical, I and II.....	39
of Vyrnwy Dam.....	88	Tytam Dam.....	123
Specifications for New Croton Dam.....	367	Upper Otary Dam.....	220
Spier Falls Dam.....	194	Urft Dam.....	90
Stearns, F. P.....	194, 244, 245	Val de Inferno Dam.....	59
Steel Dams.....	294	Value, B. R.....	184
Stokes, F. W. S.....	109	Valve-tower.....	229
Stoney, F. G. M.....	351, 357	Vassy cement used in Furens Dam.....	66
Stoney Roller Sluice-gates.....	102, 351, 357	Vehar Dam.....	235
Stop-cock vault for dams.....	231	Verdon Dam.....	70
Strachey, Gen.....	119	Vertical component of water pressure:	
Sullivan, Rider & Dougherty.....	146	effect of including.....	29
Suresnes Dam.....	322	omitted in calculations by Rankine .....	5
Sweet, Elnathan.....	243	omitted in finding Theoretical Profiles .....	20
Sweetwater Dam.....	136	Vicat, M., gives crushing strength of mortar .....	70
Tabean Dam.....	240	Villar Dam .....	61
Tâche Dam.....	72	Vioreau Dam.....	63
Tanks in India.....	233	Vyrnwy Dam.....	82
Tansa Dam.....	116	Wachussetts Dam .....	185
Teichmann, F.....	204	Wagoner, Luther.....	141
Temescal Dam.....	237	Waialua Dam.....	259
Tenango Dam.....	264	Walnut Grove, rock-fill dam .....	269
Tension in masonry.....	4	Walter, R. F.....	246
in Djidionia Dam.....	99	Washburn, Shaler & Washburn .....	152
in Hamiz Dam.....	100	Waste-pipes .....	228
Ternay Dam.....	69	Waste-weir .....	50, 225
Terrace Dam .....	263	Water pressure:	
Thénard Shutter-dams .....	325	effect against curved dam.....	47
Thirlmere Dam .....	89	effect of vertical component of.....	29
Thomas' A.-frame dam.....	323, 365	hydrostatic, considered only.....	20
Thomas, B. F.....	302, 323, 363	vertical component of, neglected in calculations .....	5, 20
Tibi, Dam of .....	54	Waves, resistance to.....	20, 34
Tillot Dam .....	64	Weight of dam to resist the thrust of the water.....	12
Timber Dams .....	280	Weight of masonry:	
abutments .....	281	effect of.....	29
aprons.....	281	given by various authorities.....	29
leakage.....	281	Weir-formula.....	226
profiles.....	280	Wells, Chas. E.....	204, 246
sheet-piling .....	281	Welsh, Ashbel .....	344
Titicus Dam.....	150	Western, Lieut. Colonel .....	104
Tlélat Dam.....	98	Wheeler, Edgar T.....	46
Toolsee Dam.....	124	White, Josiah .....	344
Top of masonry dam, superelevation above water of .....	36	Whitehouse, F. C.....	109
Top-width of masonry dam, size of.....	36	Whiting, J. E.....	118
Torricelli, Signor.....	104	Wicket-dams.....	327
Trapezoid representing reaction of foundation.....	13	Wigwam Dam.....	120
Triangle representing reaction of foundation .....	13		

*INDEX.*

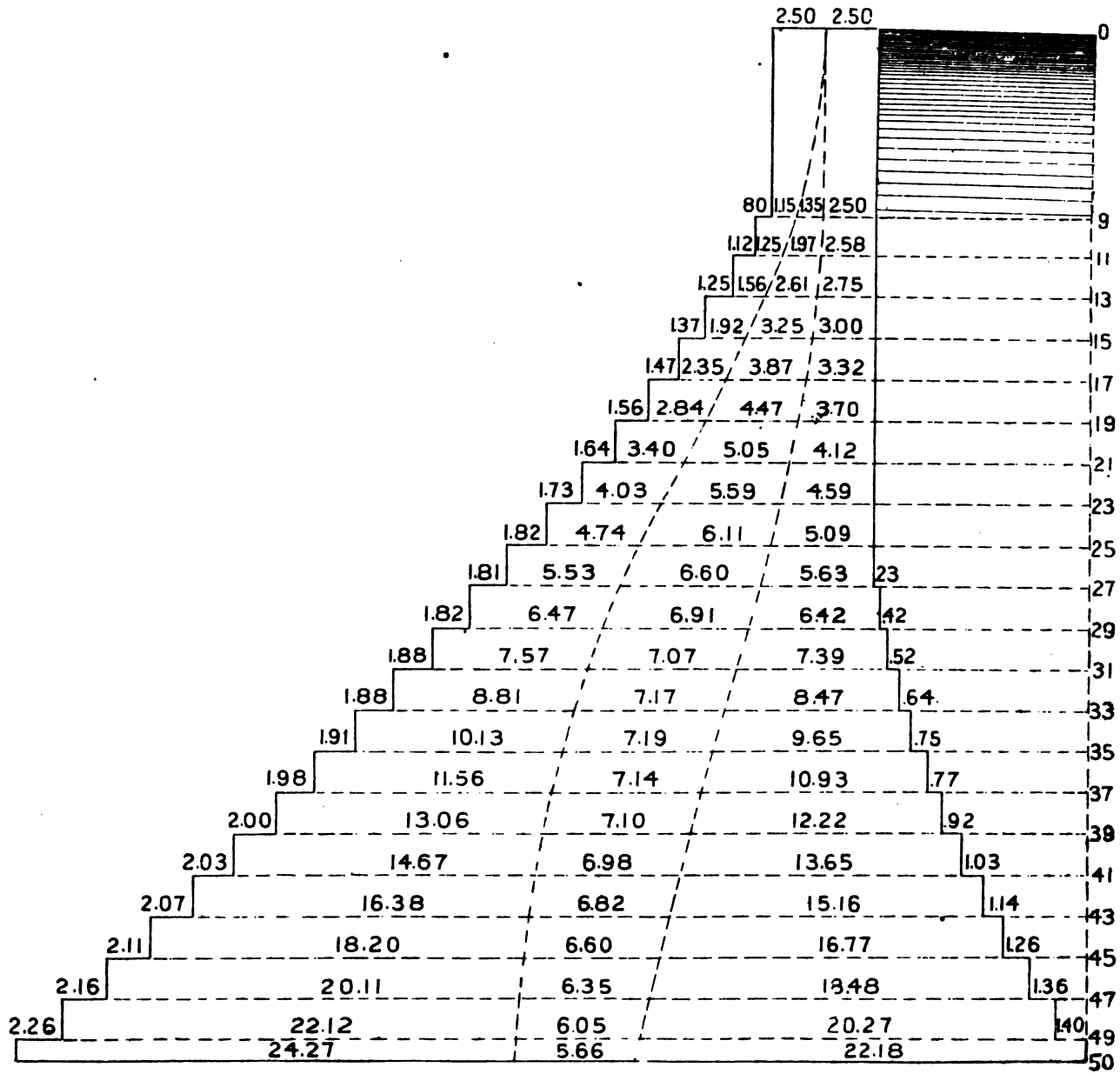
421

	PAGE		PAGE
Wiley, A. J. ....	202	Yarrow Dam .....	235
Willcocks, Sir William.....	103, 104, 109	Yeuland River .....	118
Williams, Prof. G. S.....	201, 202		
Wilson, H. M. ....	118, 119, 121, 124, 220, 233, 234	Zola Dam, acts as a horizontal arch.....	46
Wilson, W. J. ....	109	description of .....	64
Wisner, Geo. Y.....	46, 204, 207	Zola, M., projector of Zola Dam .....	64
Woodward, Silas H.....	46, 199	Zorn, G. W. ....	202
Working-needle-dams, method of.....	306	Zuñ River Dam .....	260



# SAZILLY'S PROFILE TYPE

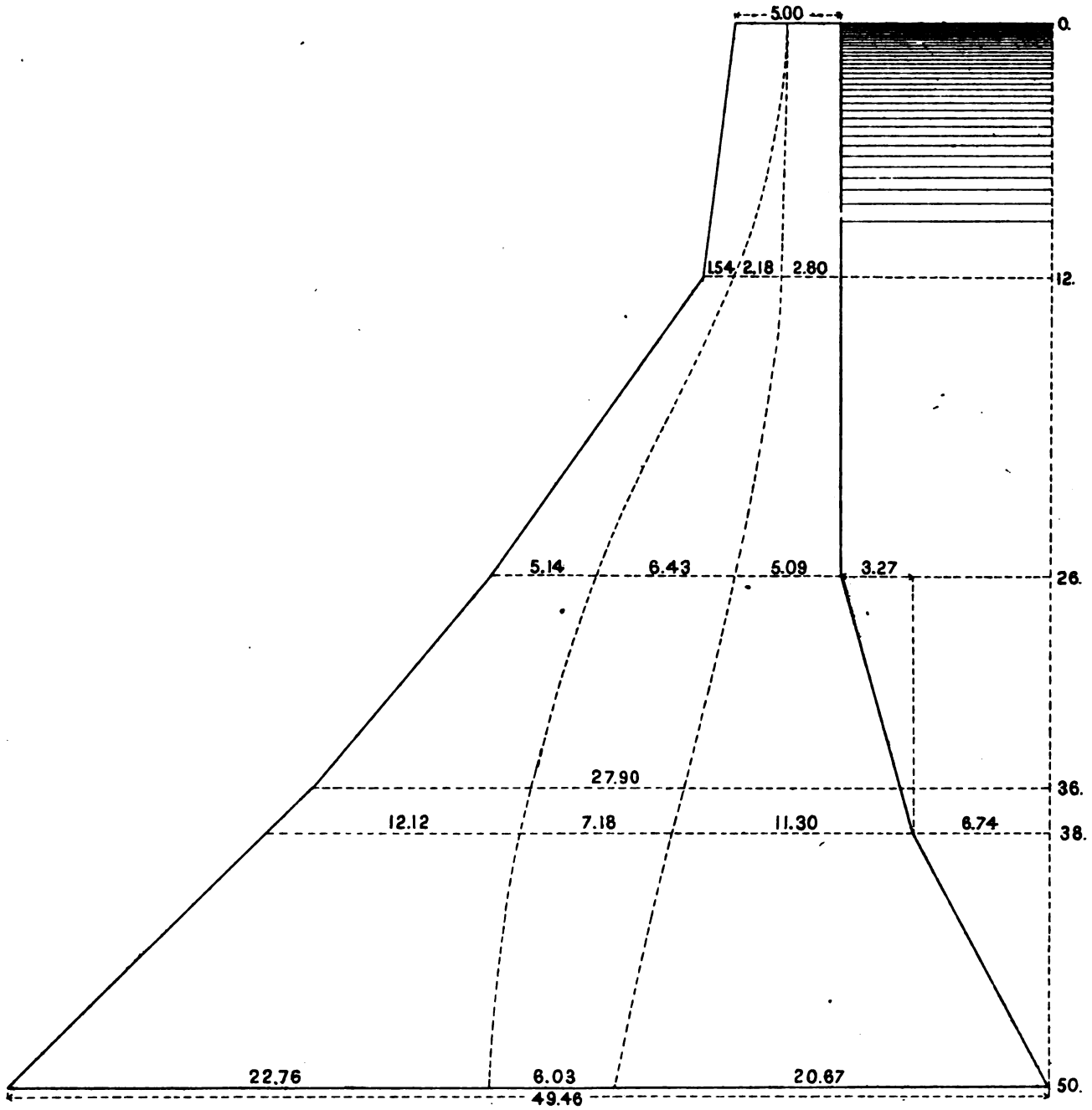
SCALE OF METRES.  
0 1 2 4 6 8 10





# DELOCRE'S PROFILE TYPE

SCALE OF METRES  
0 1 2 4 6 8 10

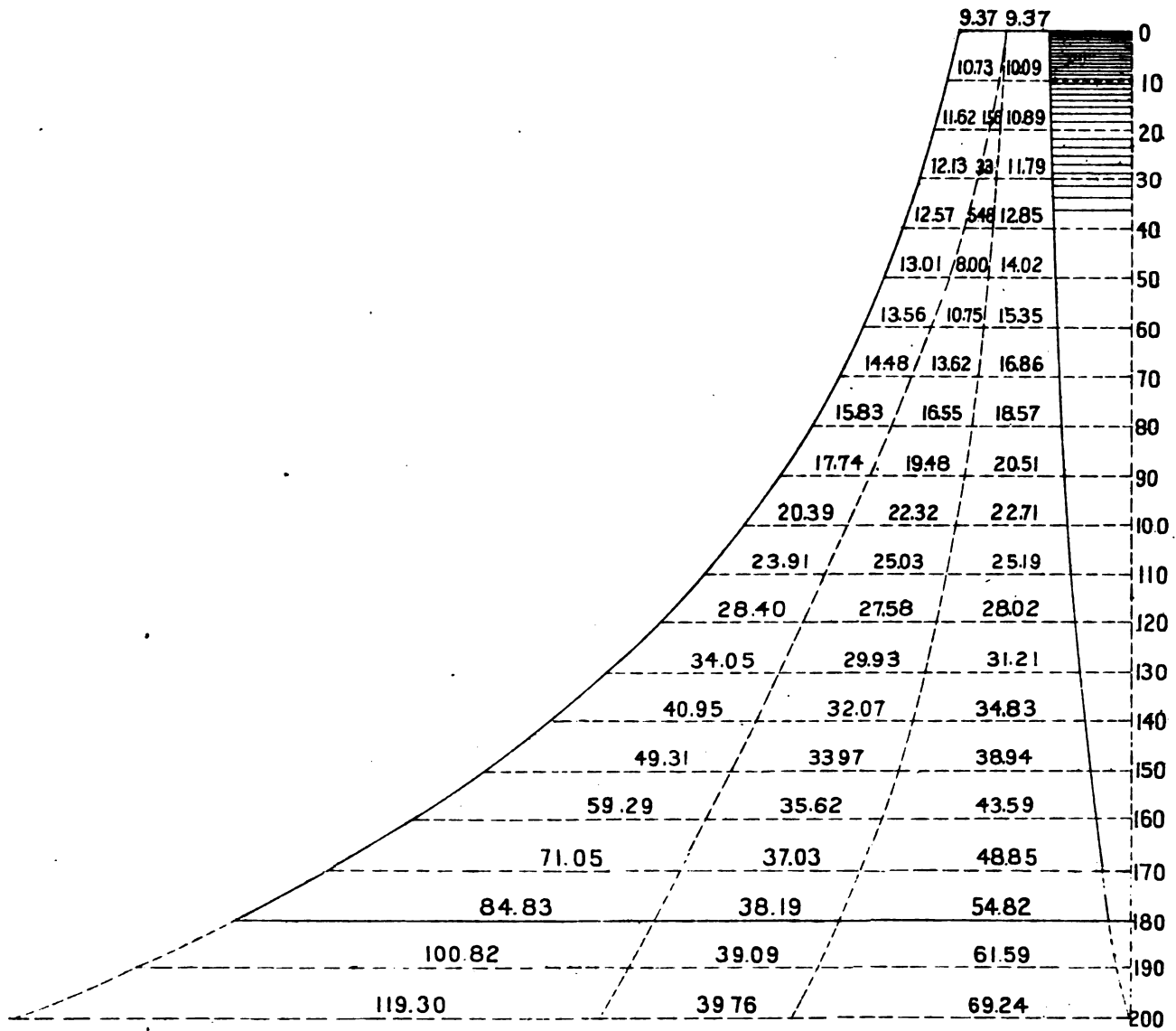






PROF. RANKINE'S PROFILE TYPE

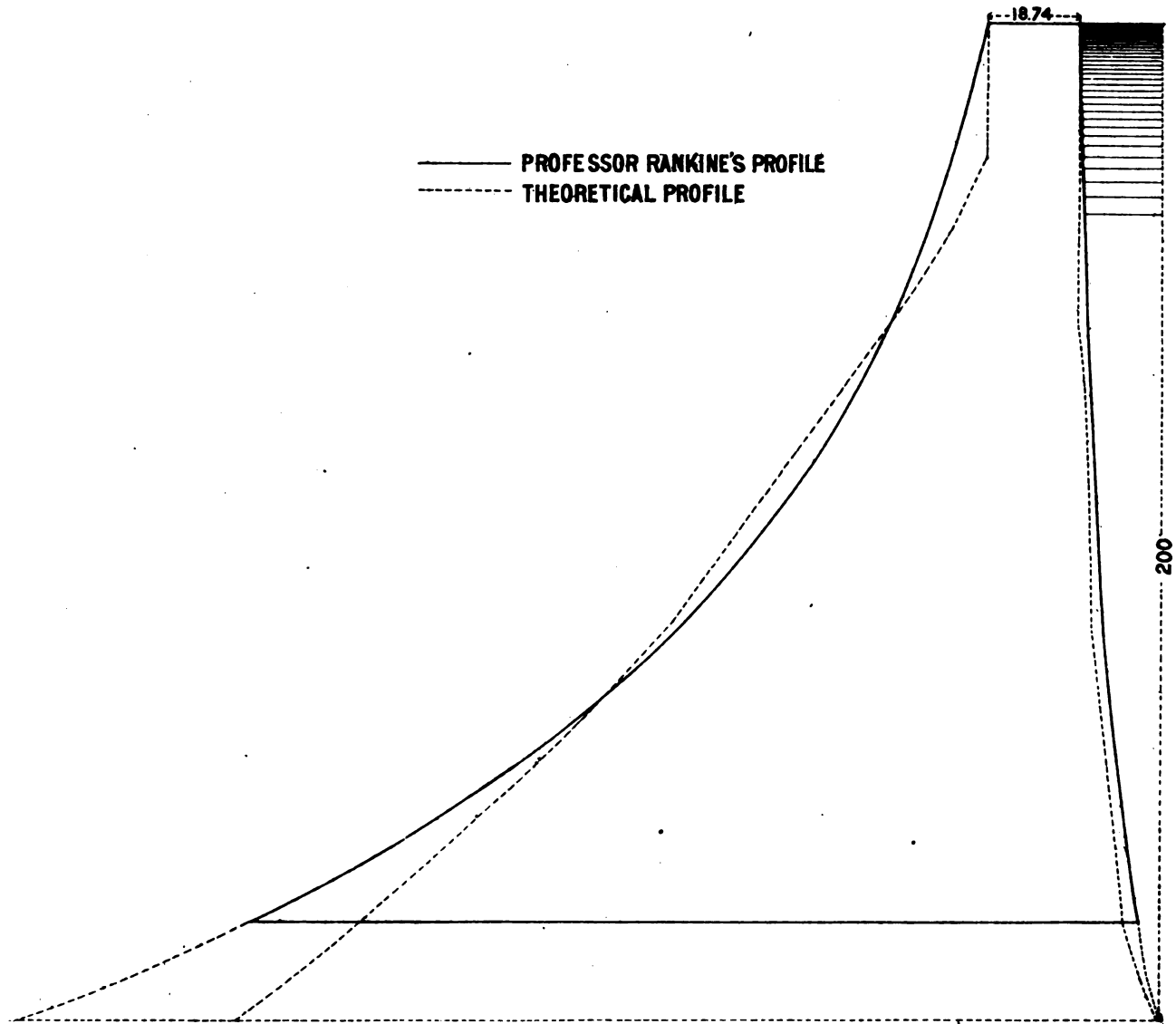
SCALE OF FEET.  
 0 5 10 20 30 40





# COMPARISON OF RANKINE'S PROFILE WITH THE THEORETICAL PROFILE

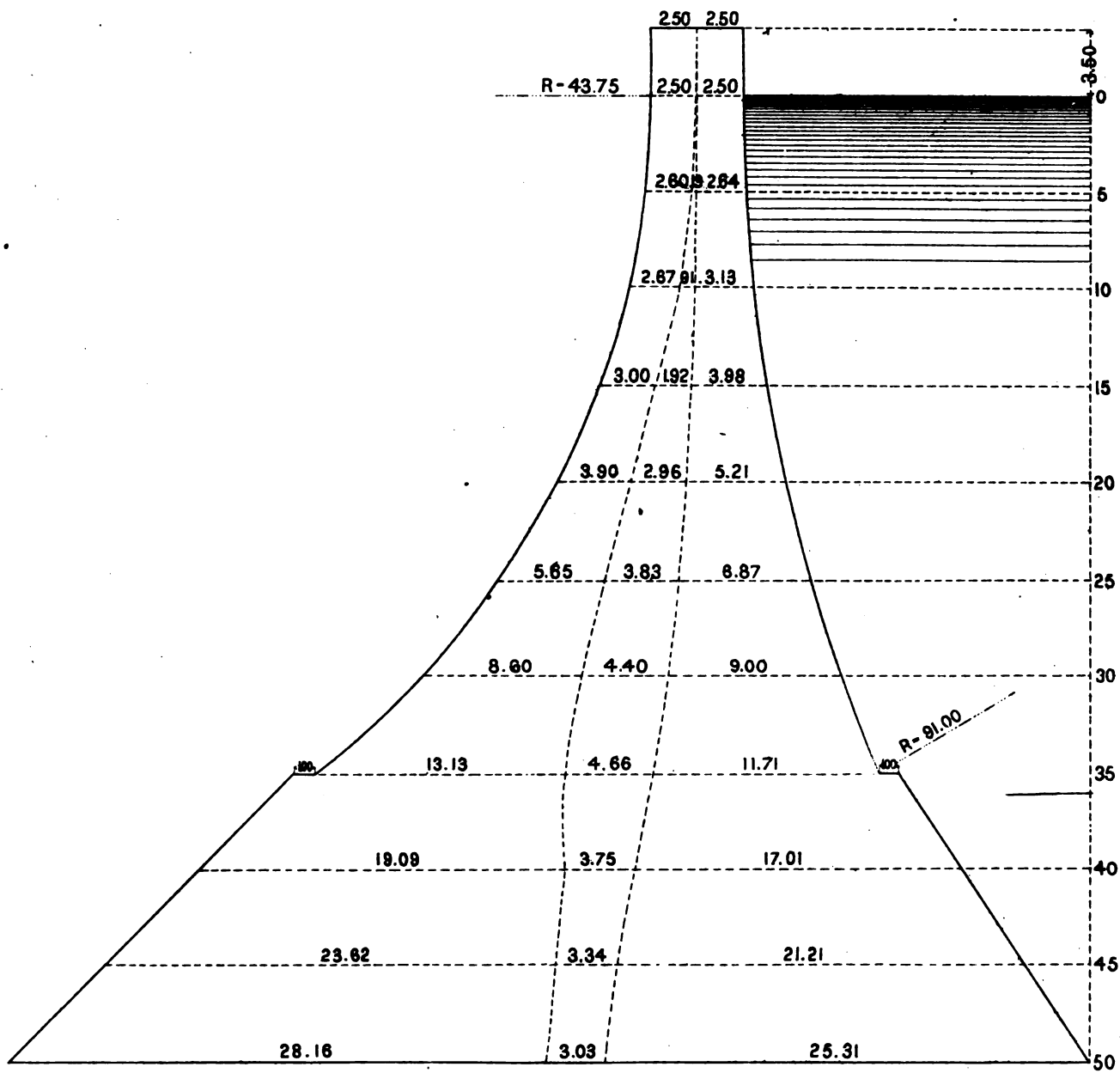
SCALE OF FEET  
0 10 20 30 40





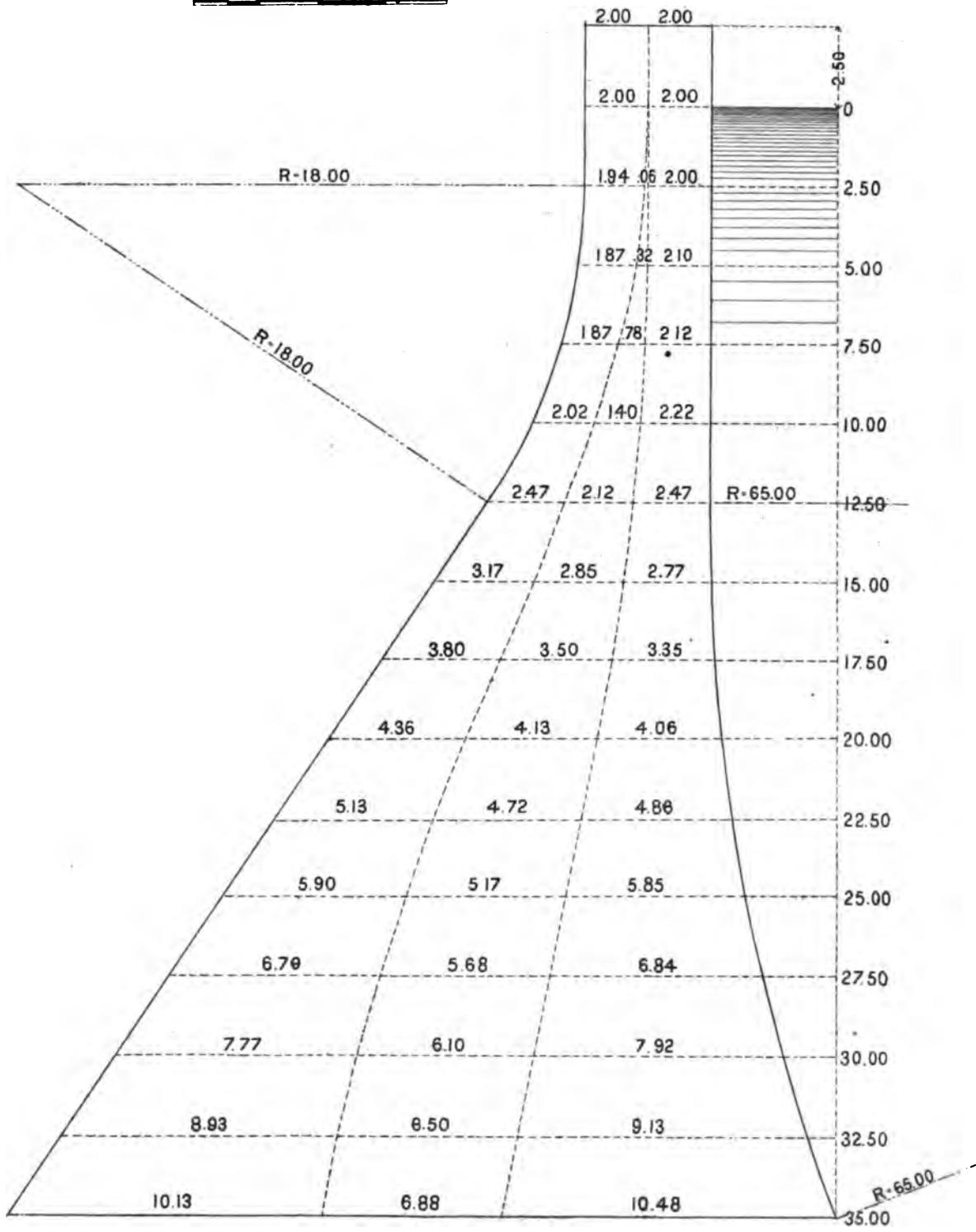
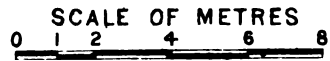
# KRANTZ'S PROFILE TYPE

SCALE OF METRES  
0 1 2 3 4 5 6 7 8 9 10





PROF. HARLACHER'S PROFILE TYPE

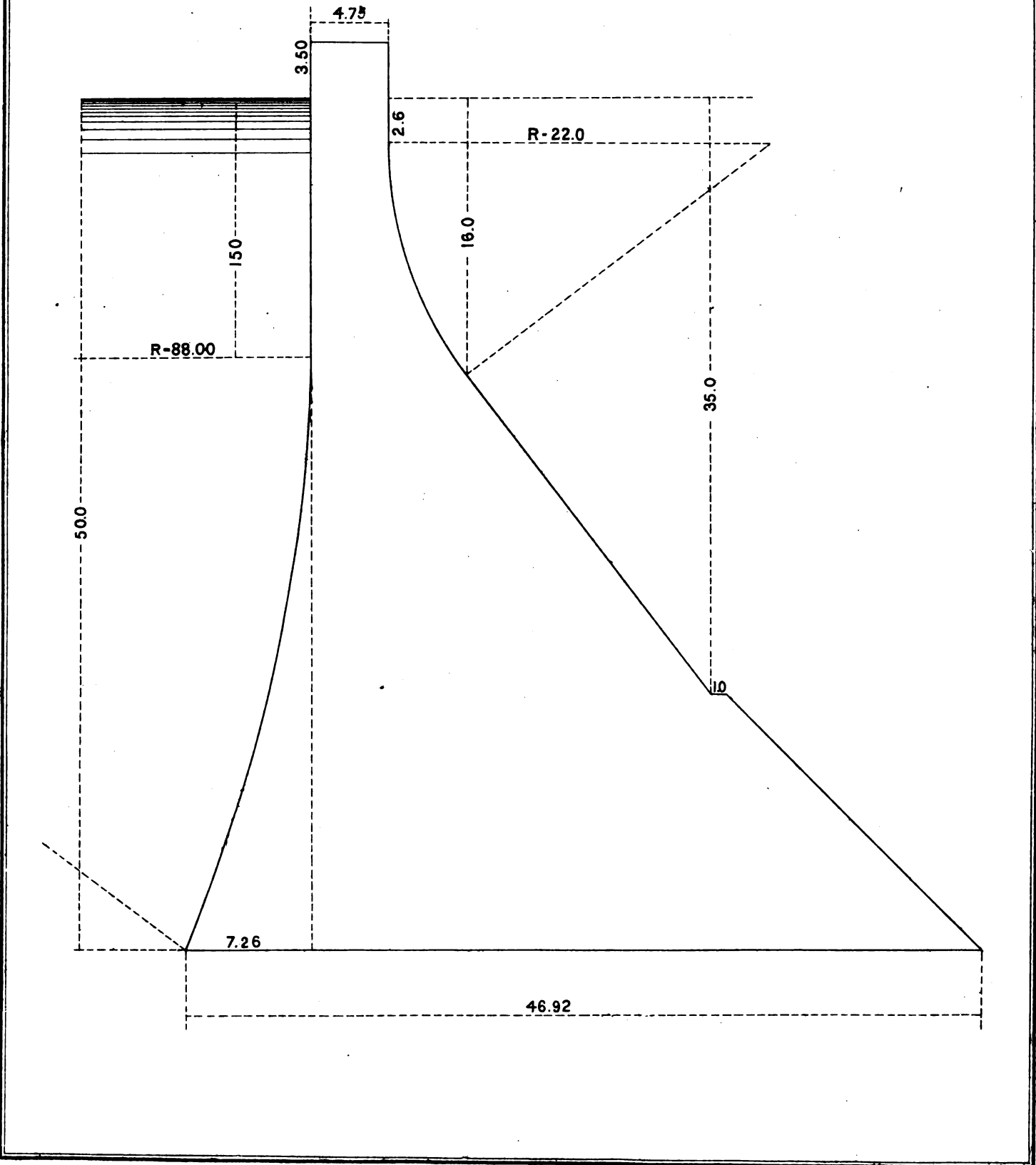






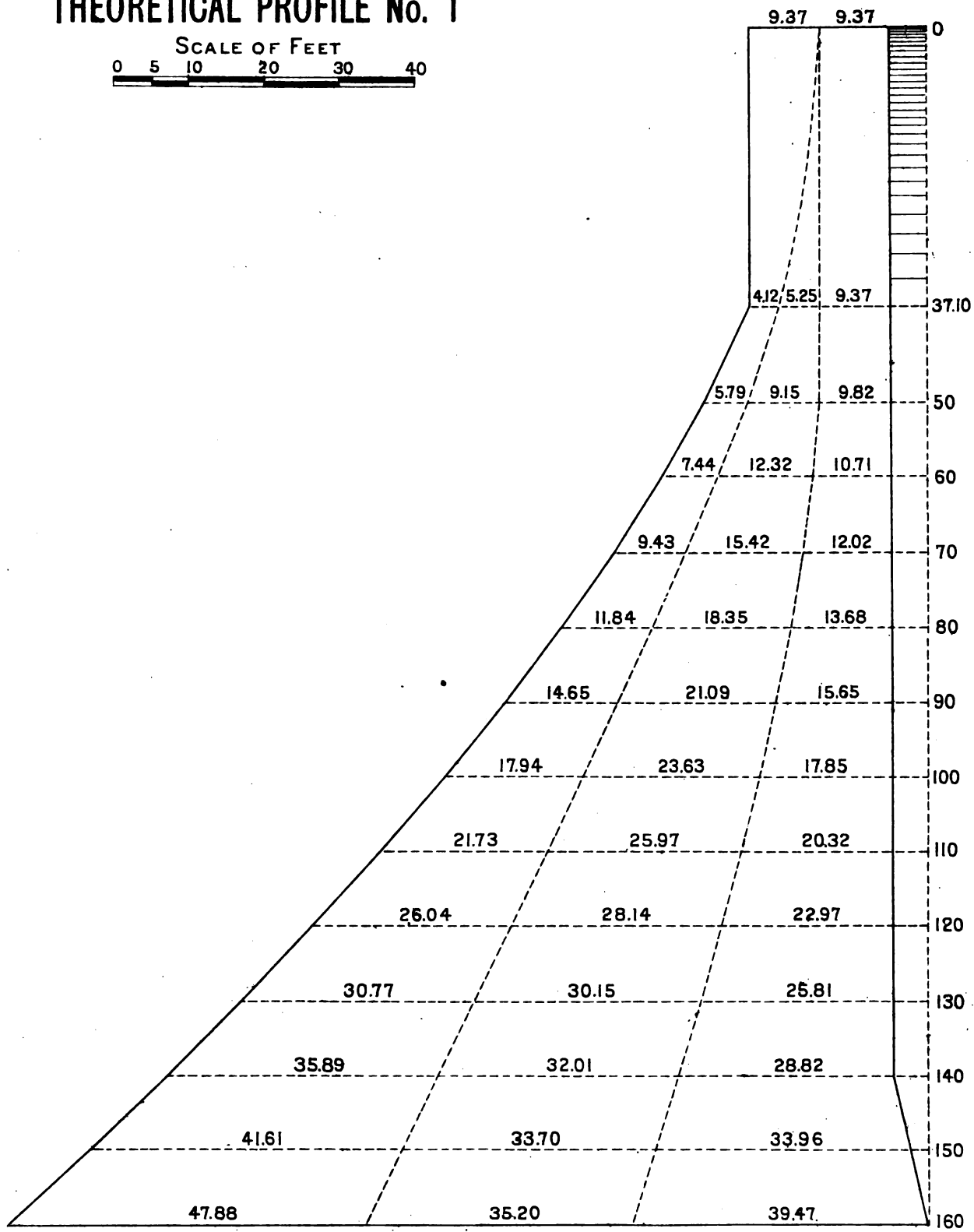
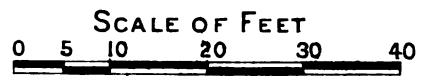
# CRUGNOLA'S PROFILE TYPE

SCALE OF METRES  
0 2 4 6 8 10 15



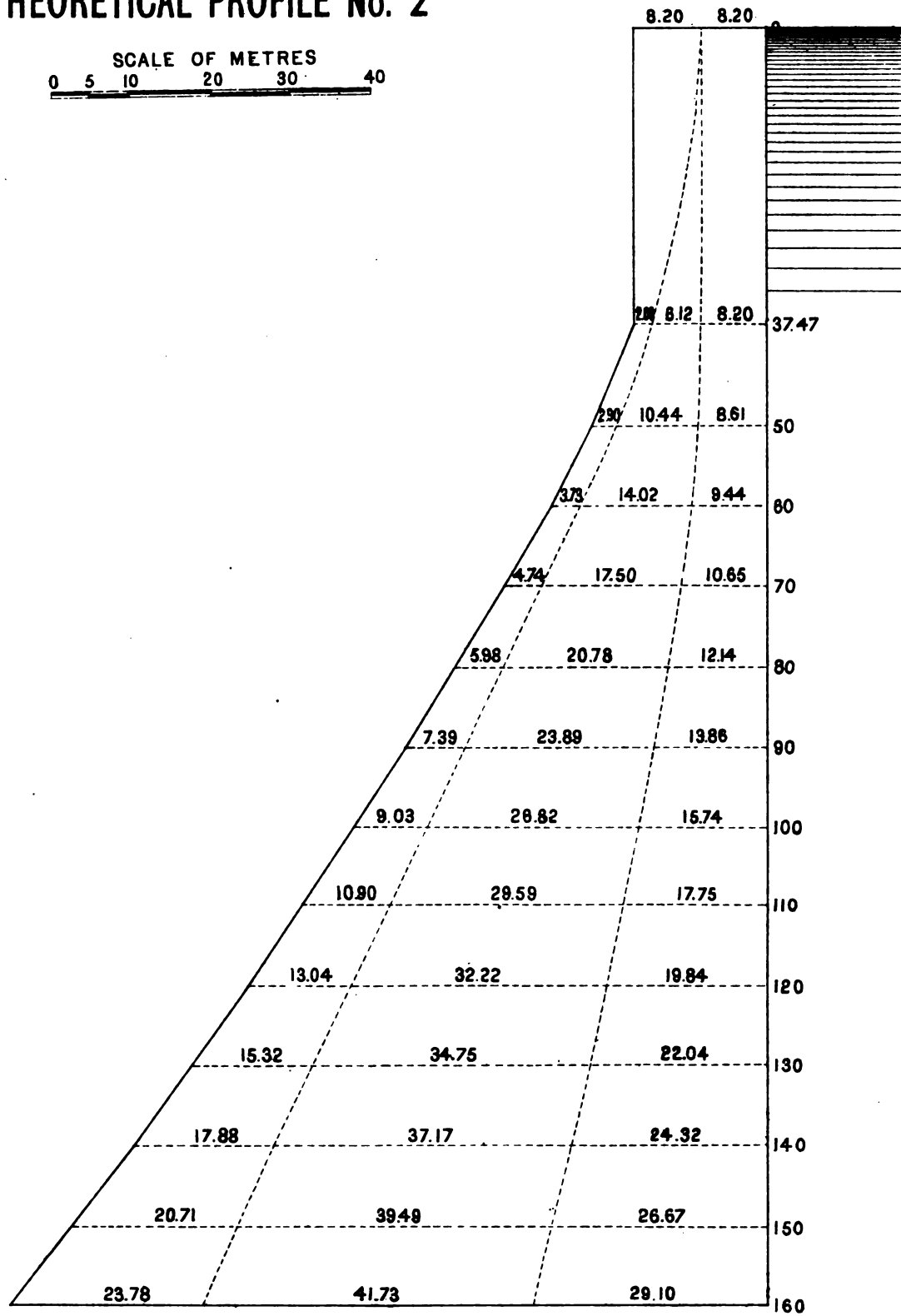
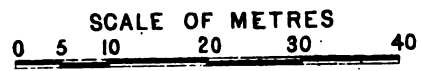
||

THEORETICAL PROFILE No. 1





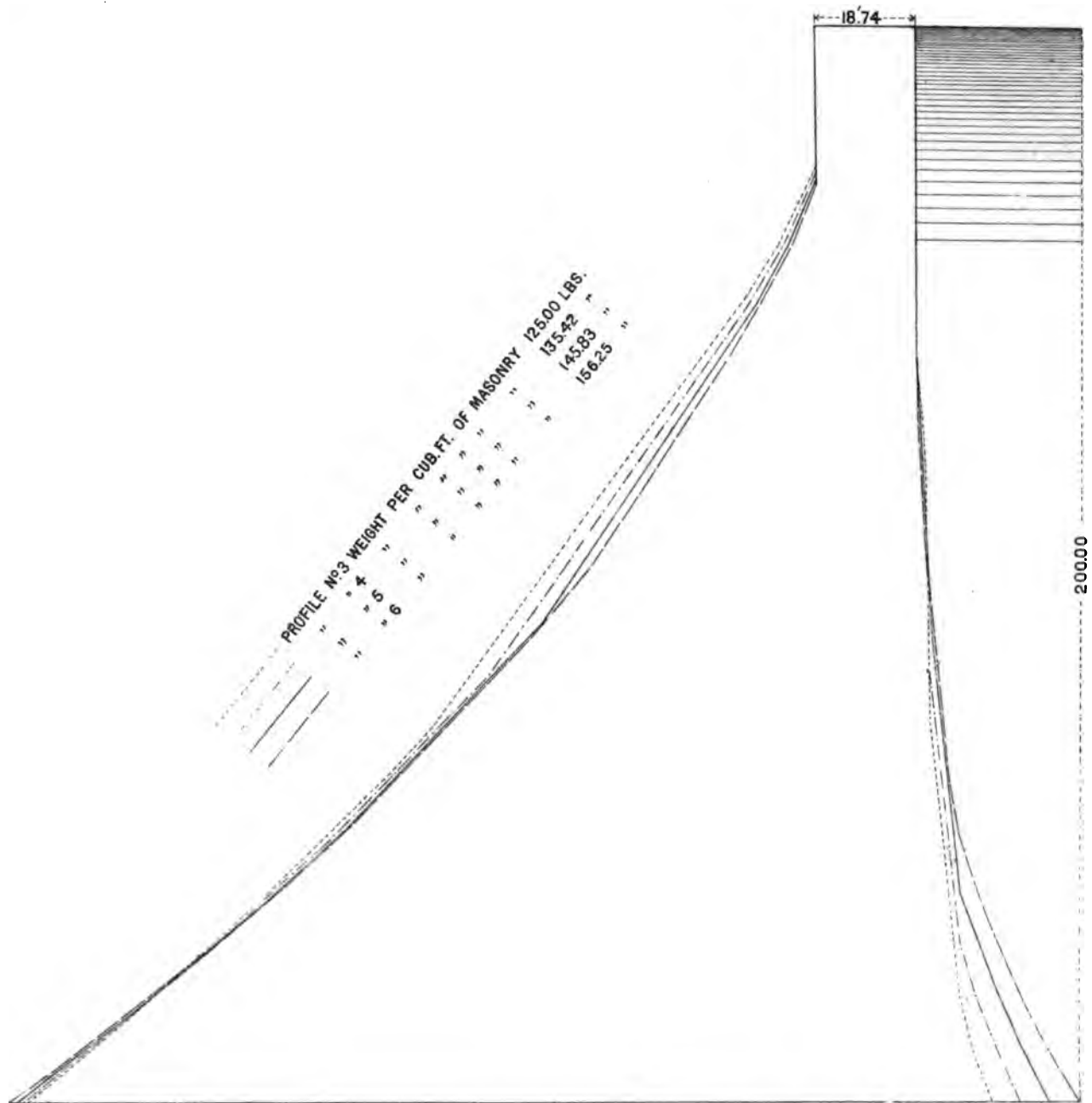
THEORETICAL PROFILE No. 2





# COMPARISON OF THEORETICAL PROFILES

SCALE OF FEET  
0 5 10 20 30 40

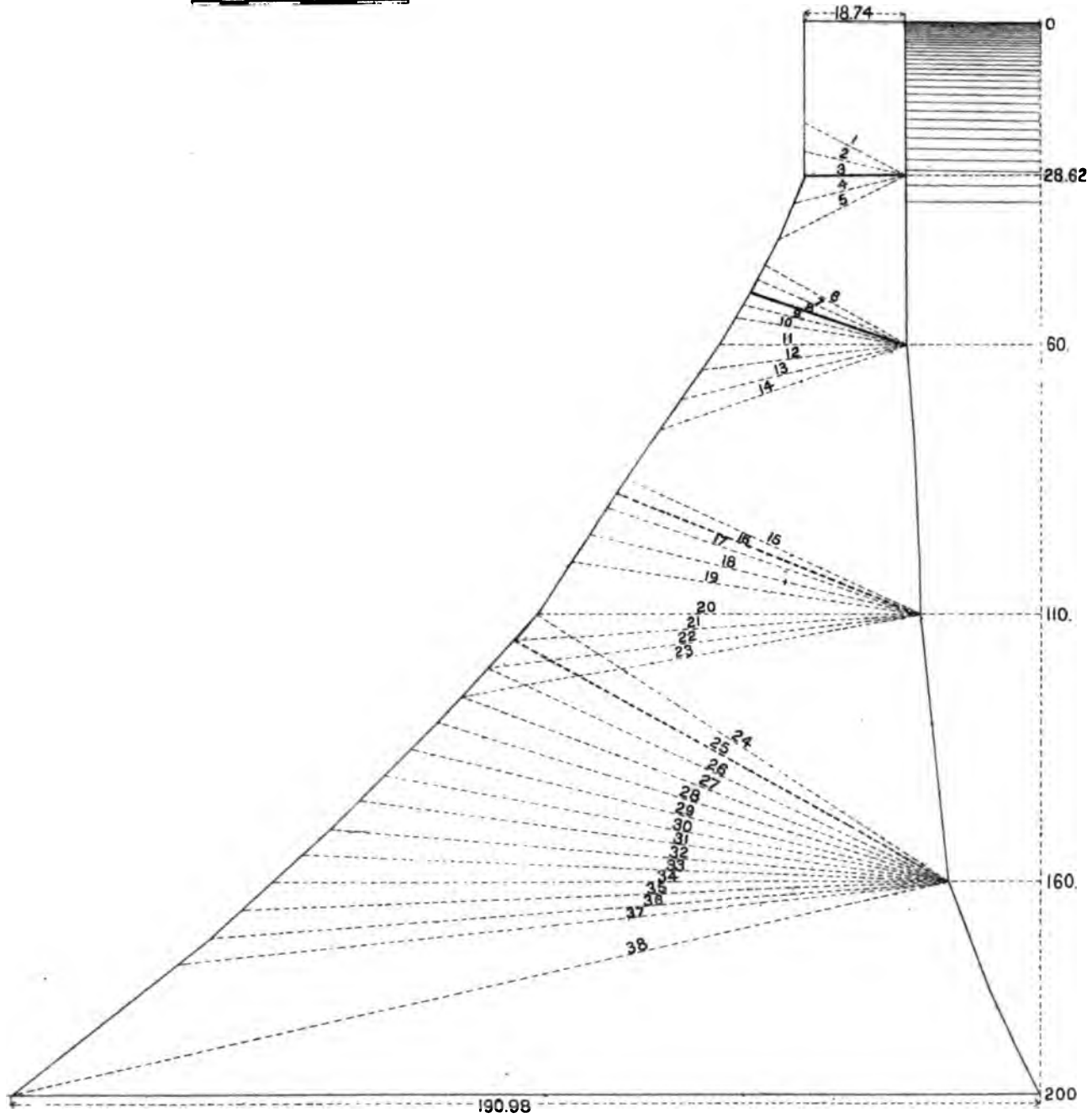






# THEORETICAL PROFILE No. 5 WITH INCLINED JOINTS

SCALE OF FEET  
0 5 10 20 30 40

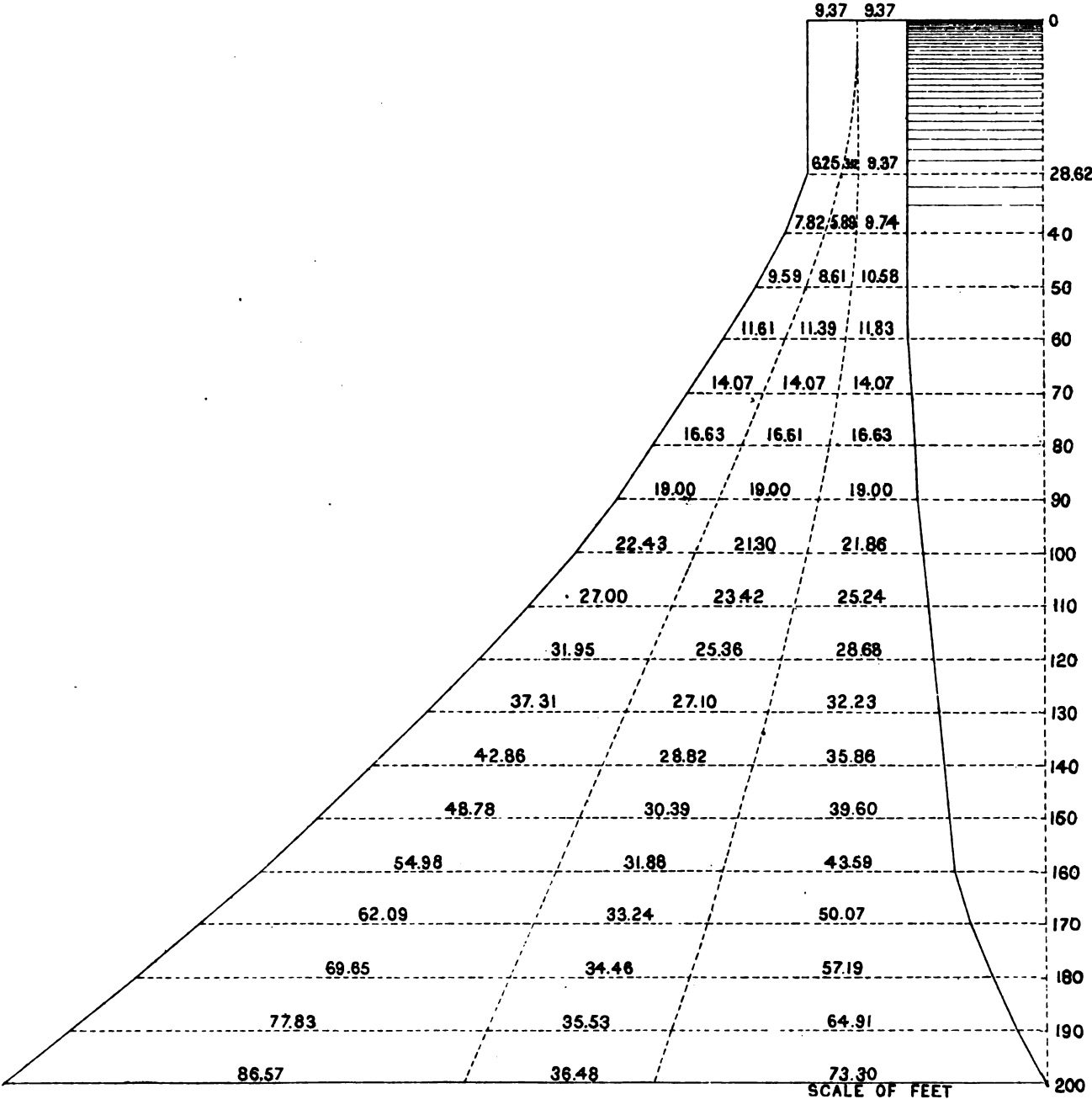


7

# THEORETICAL PROFILE No. 5

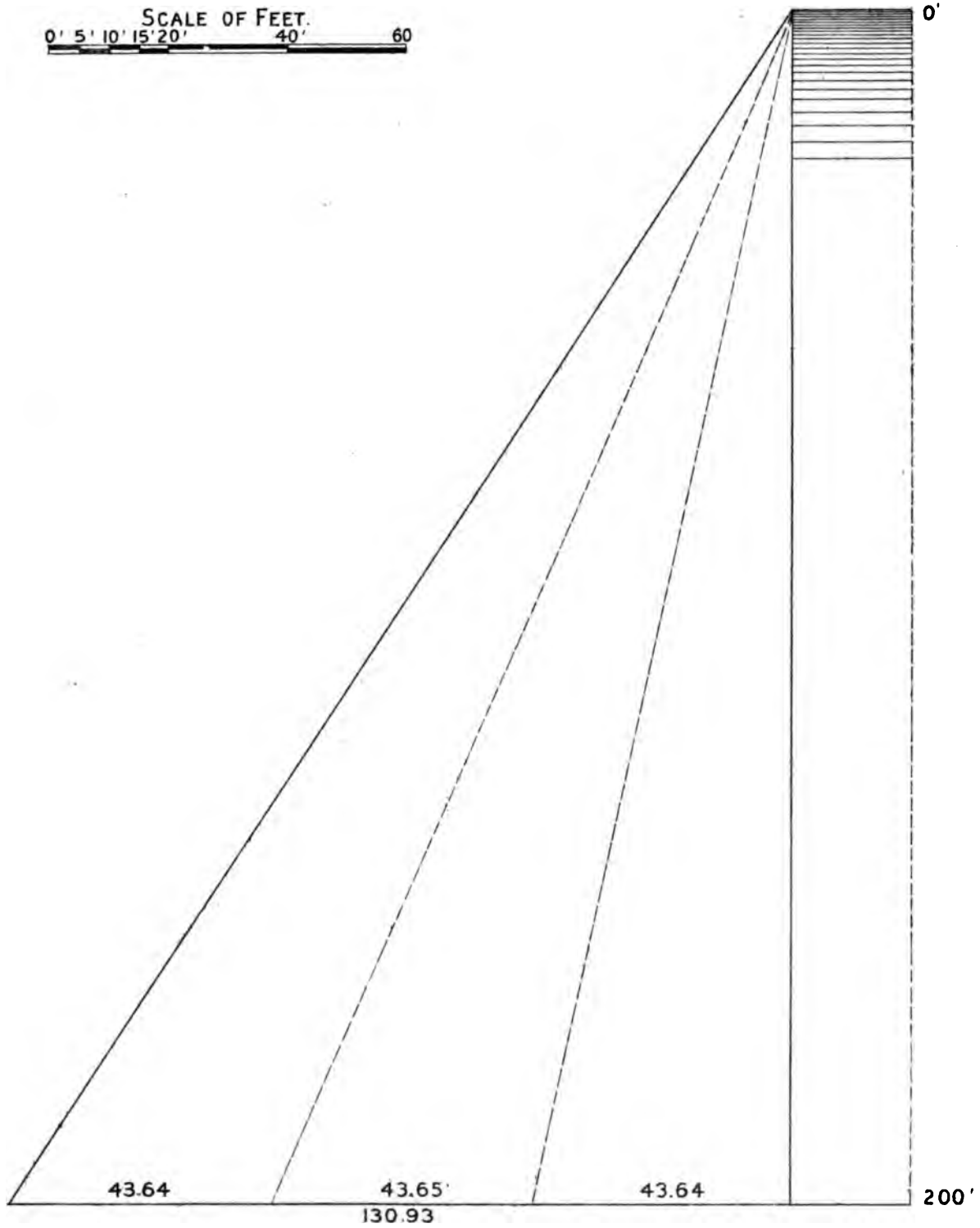
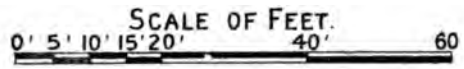
MODIFIED BY  
**M. BOUVIER'S FORMULÆ**

SCALE OF FEET  
0 5 10 20 30 40





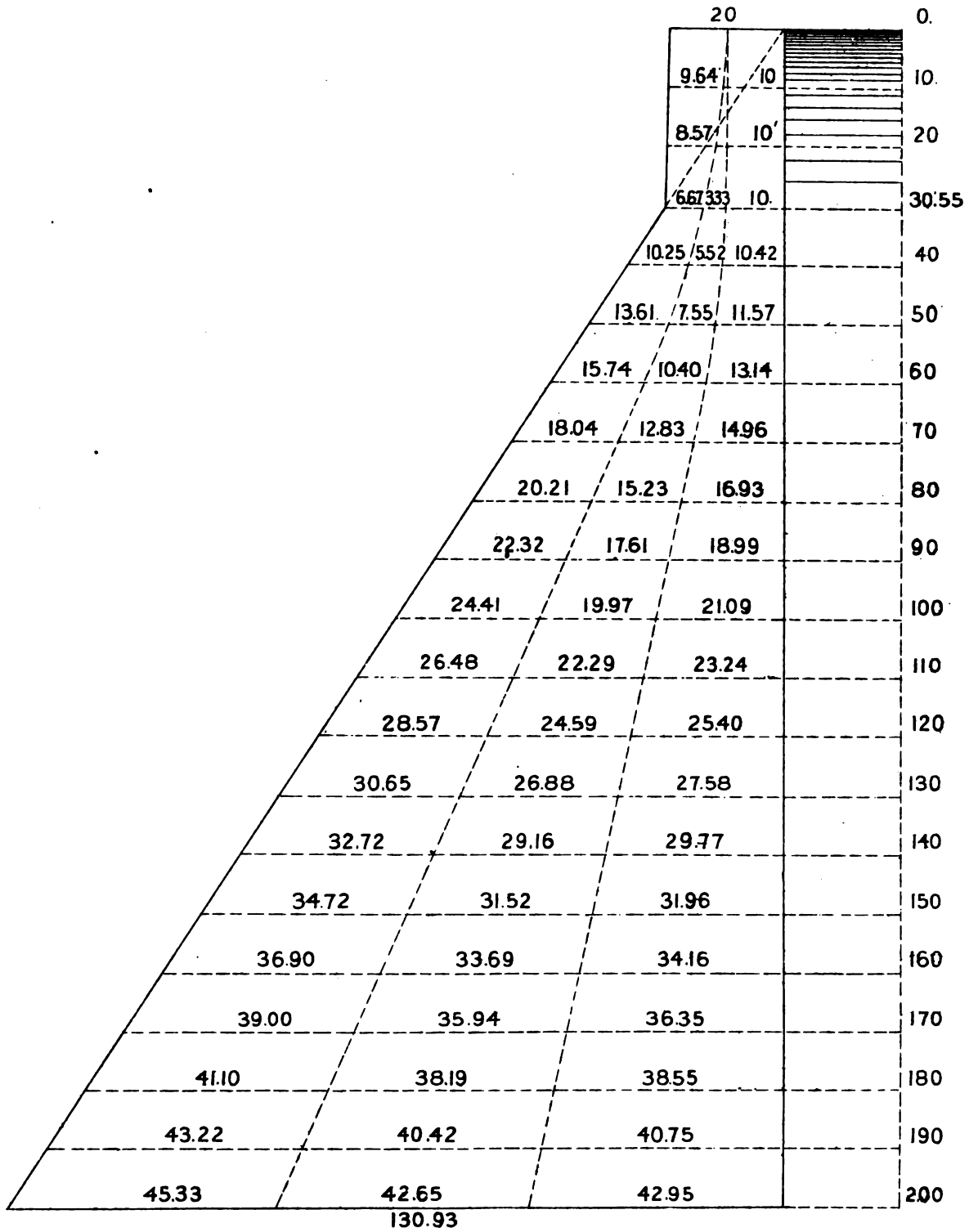
THEORETICAL TYPE No. I.





PRACTICAL TYPE No. 1

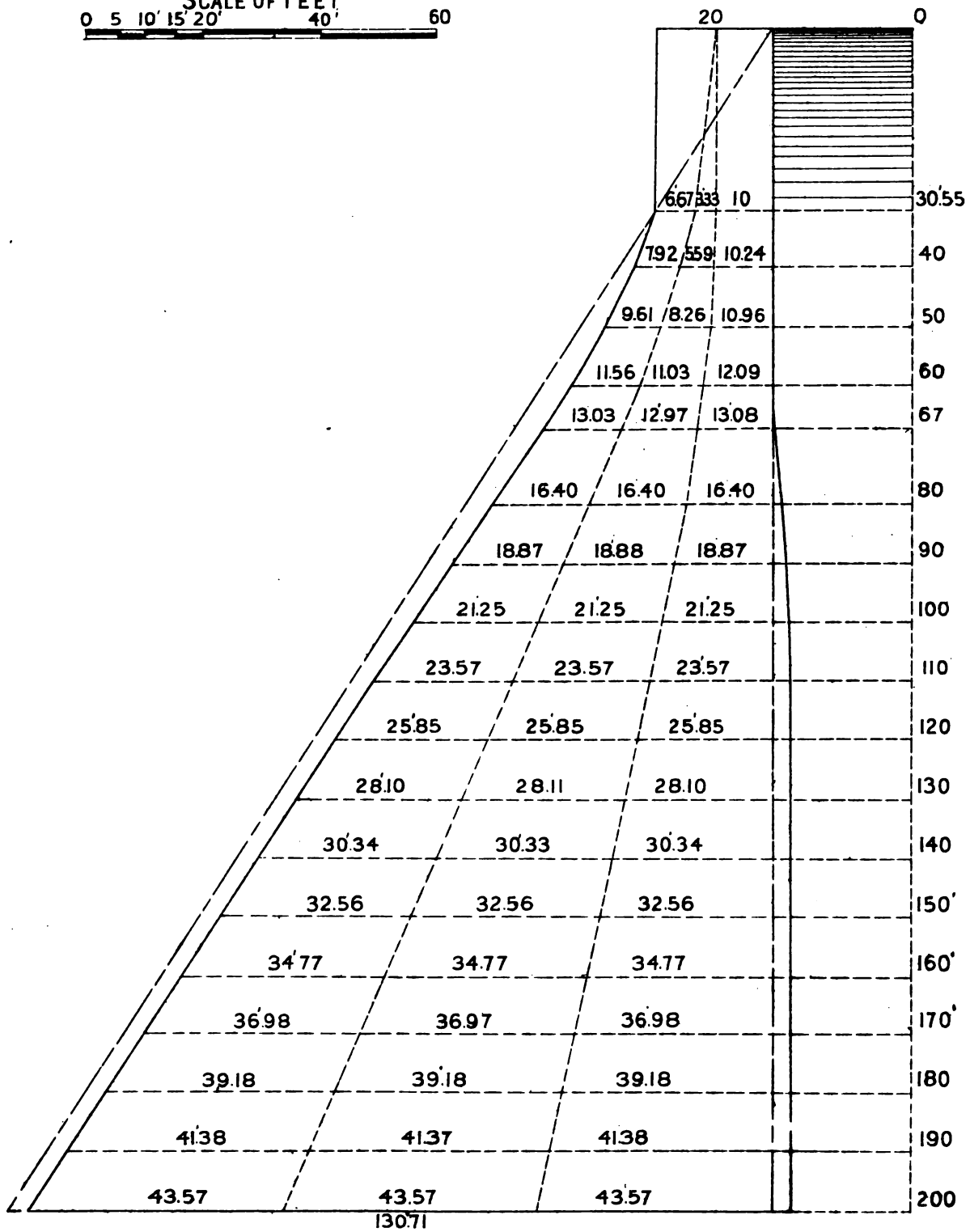
SCALE OF FEET.  
 0' 5' 10' 15' 20' 40 .60







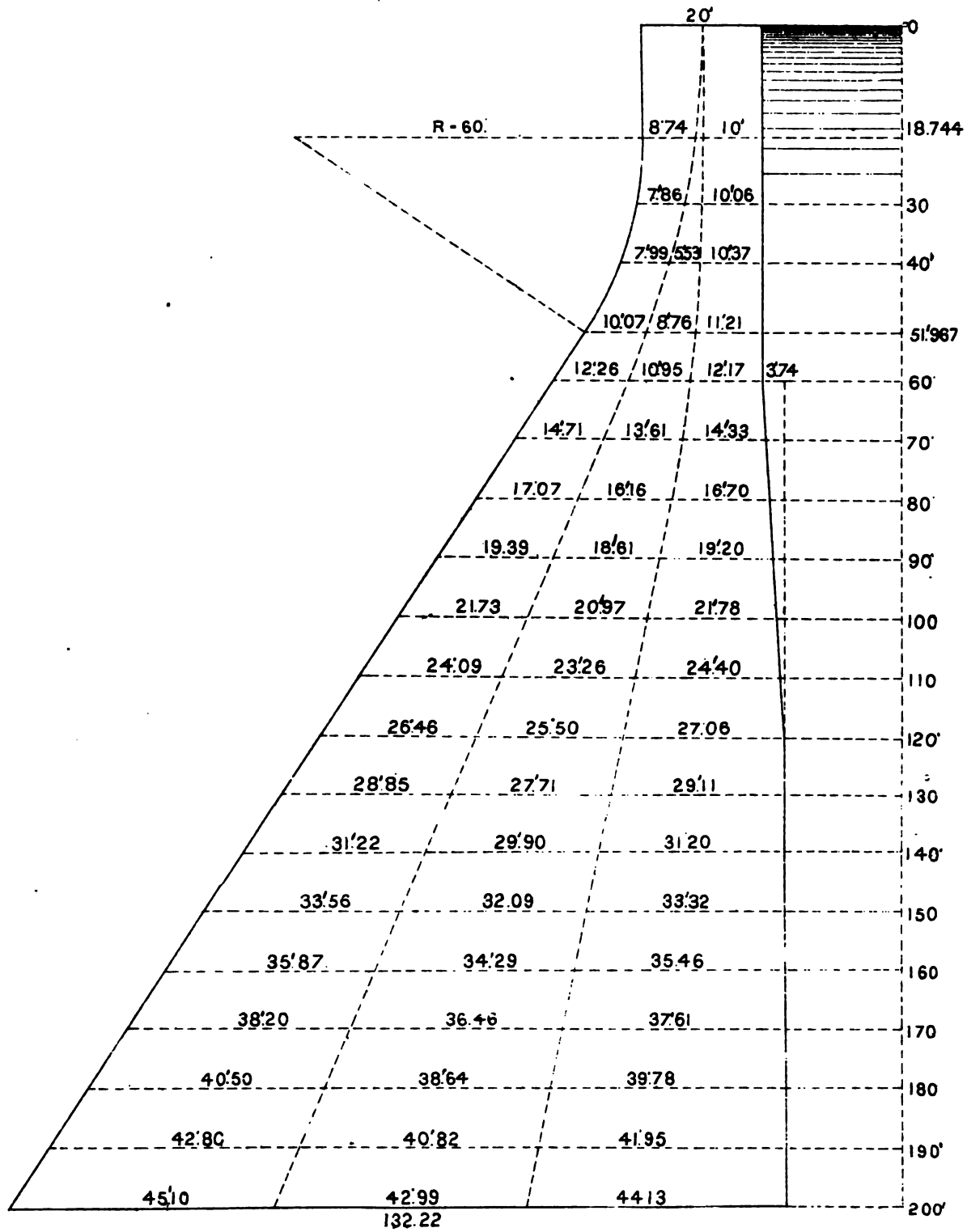
THEORETICAL TYPE No. II.



1

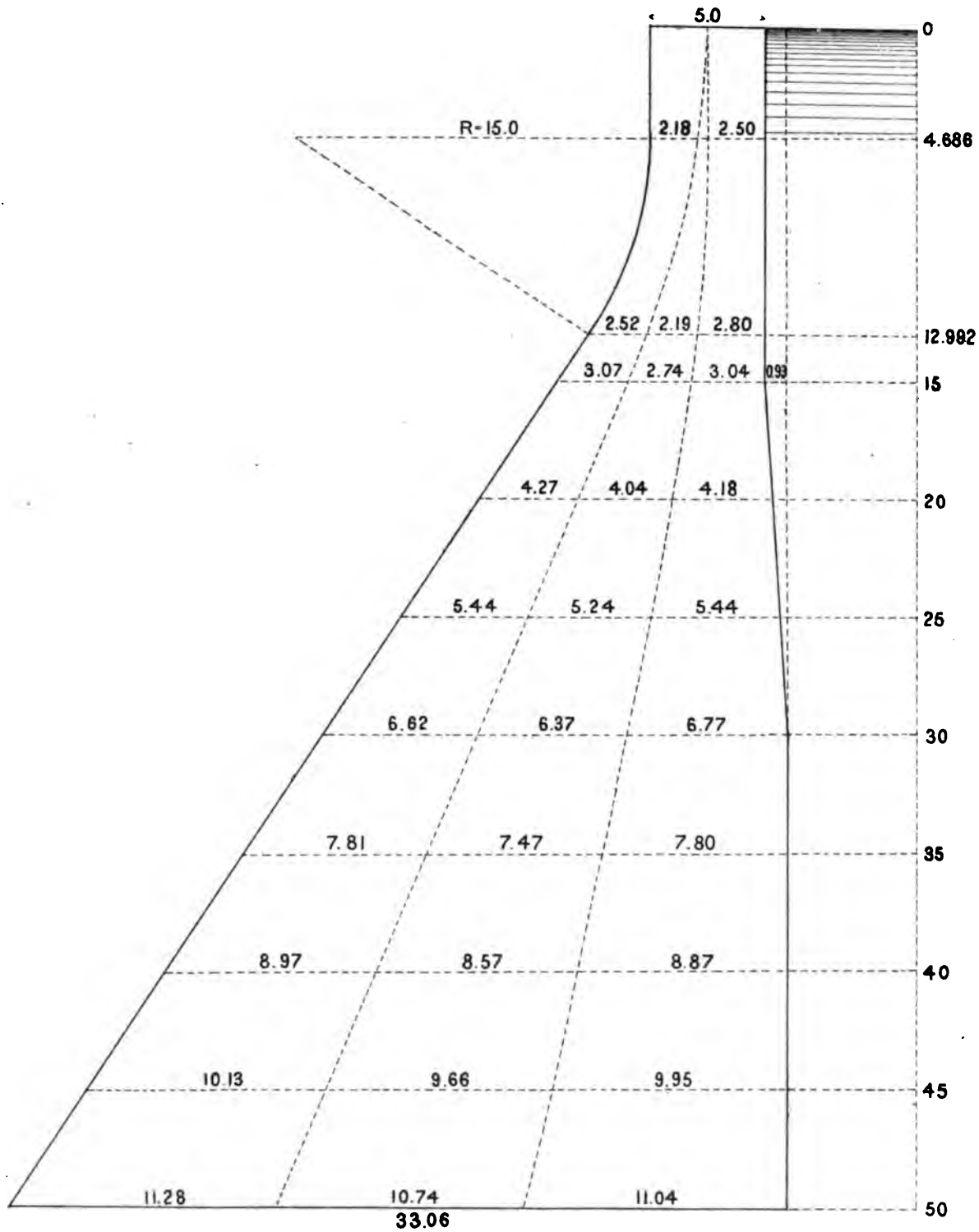
PRACTICAL TYPE No. 2

SCALE OF FEET  
 0' 5' 10' 15' 20' 40' 60'





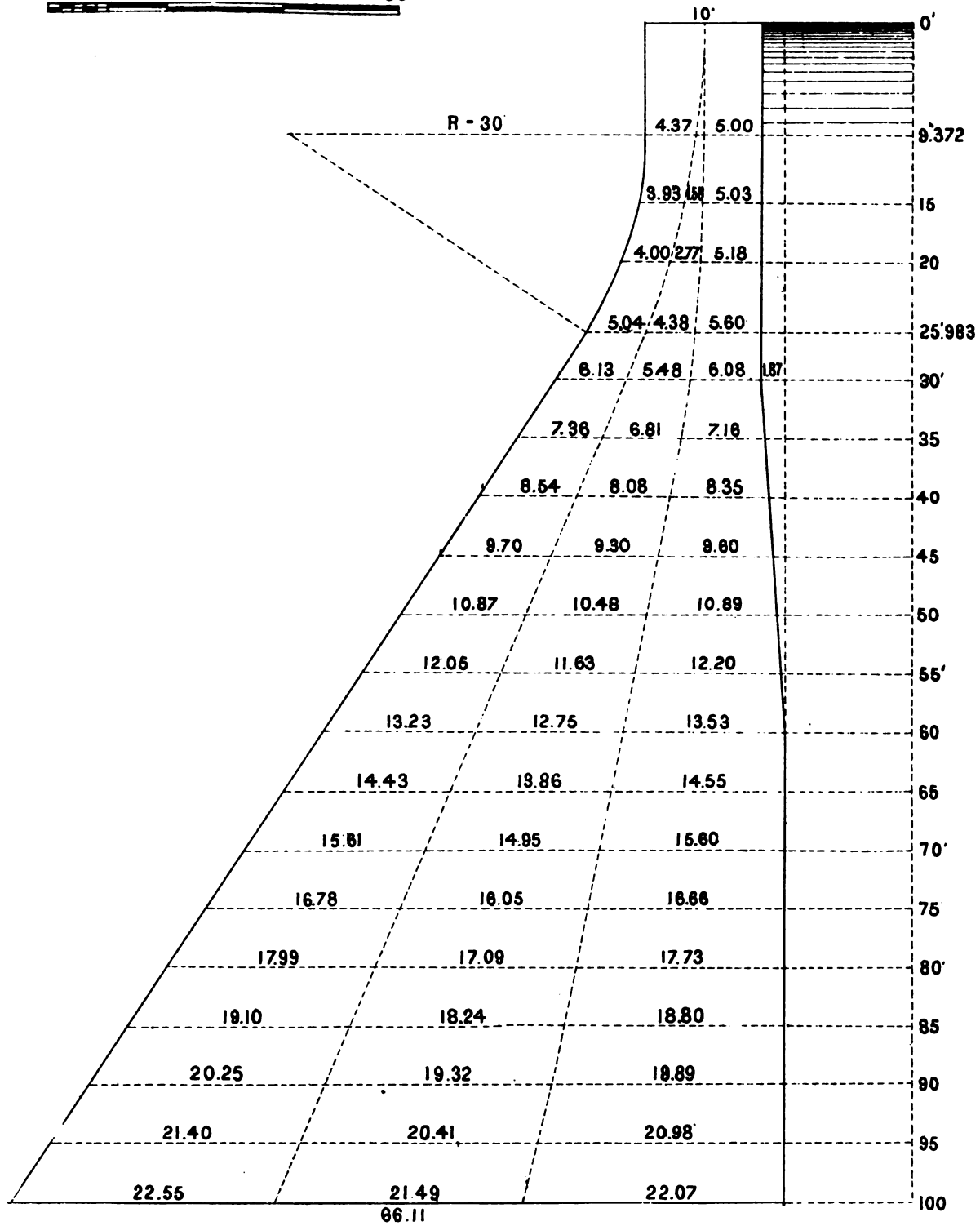
PRACTICAL PROFILE No. 1

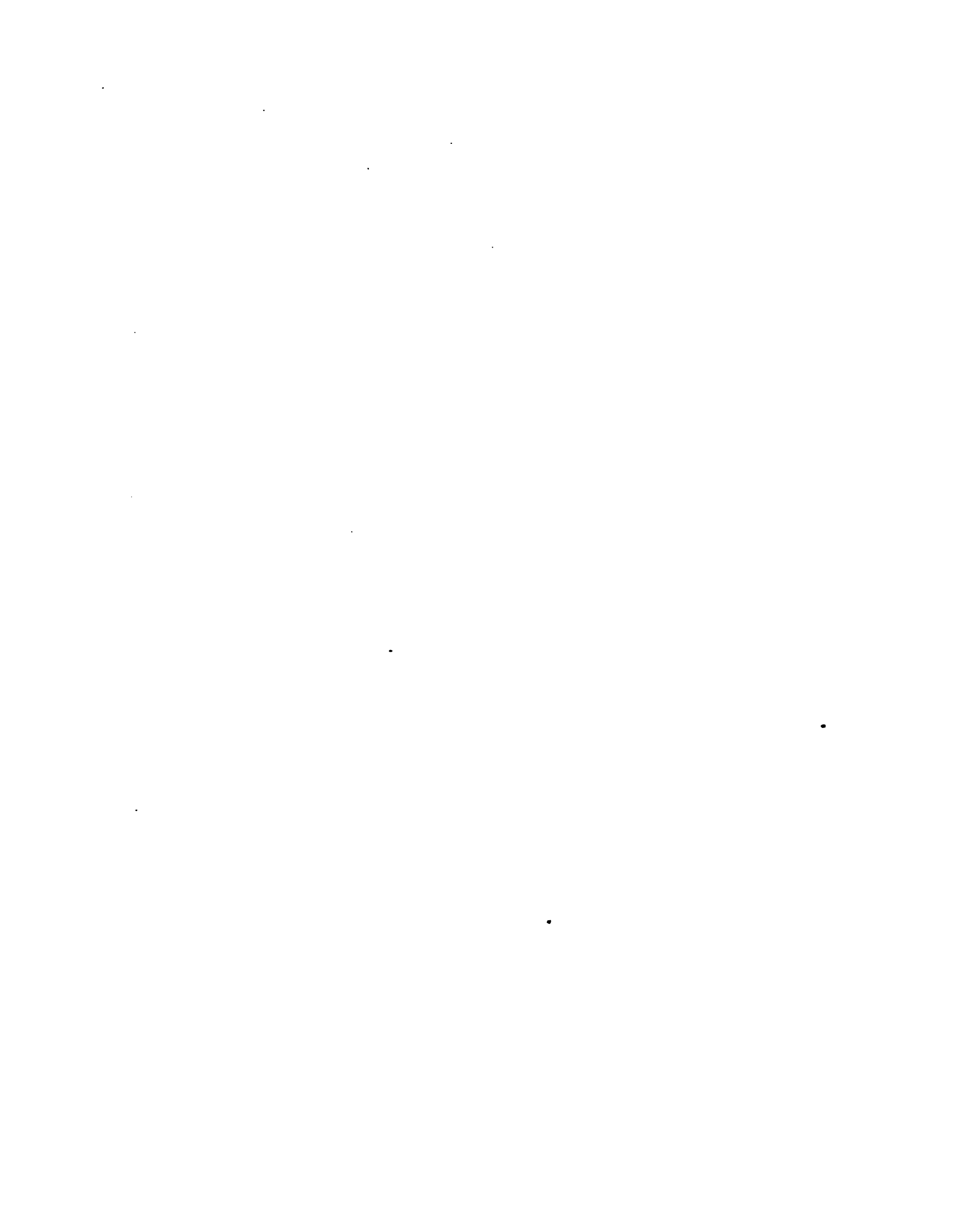




PRACTICAL PROFILE No. 2

SCALE OF FEET  
 0 10 20 30

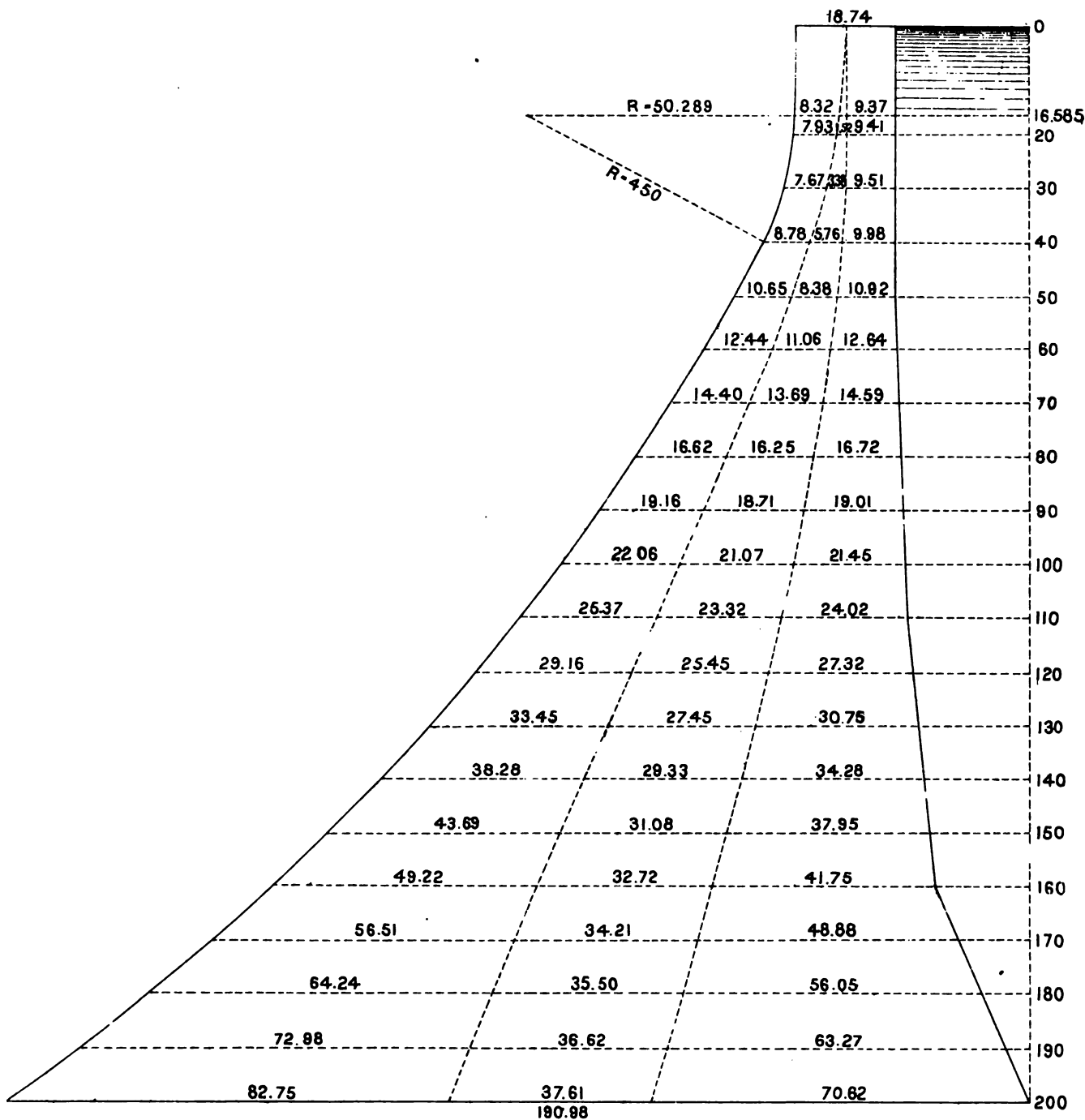


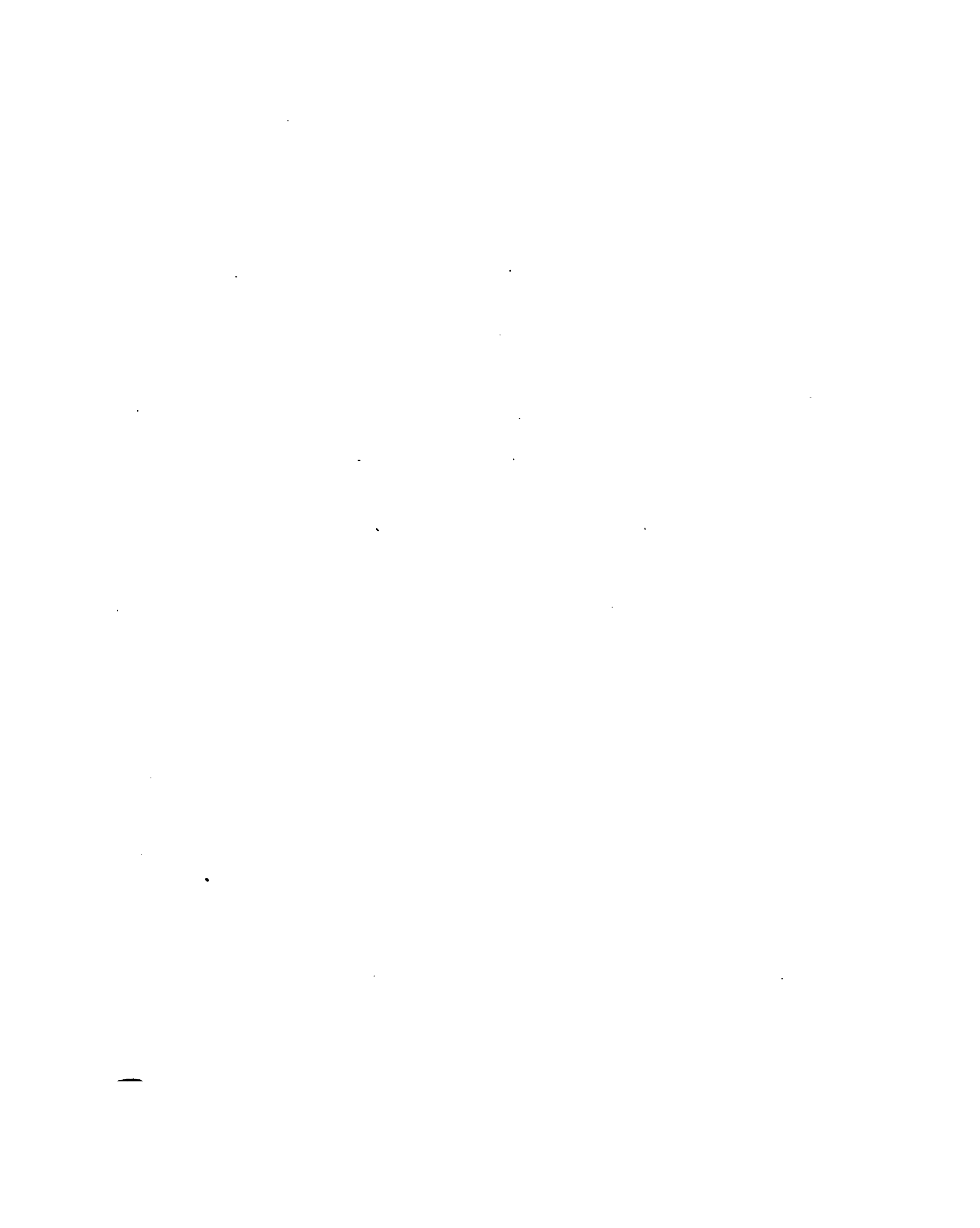




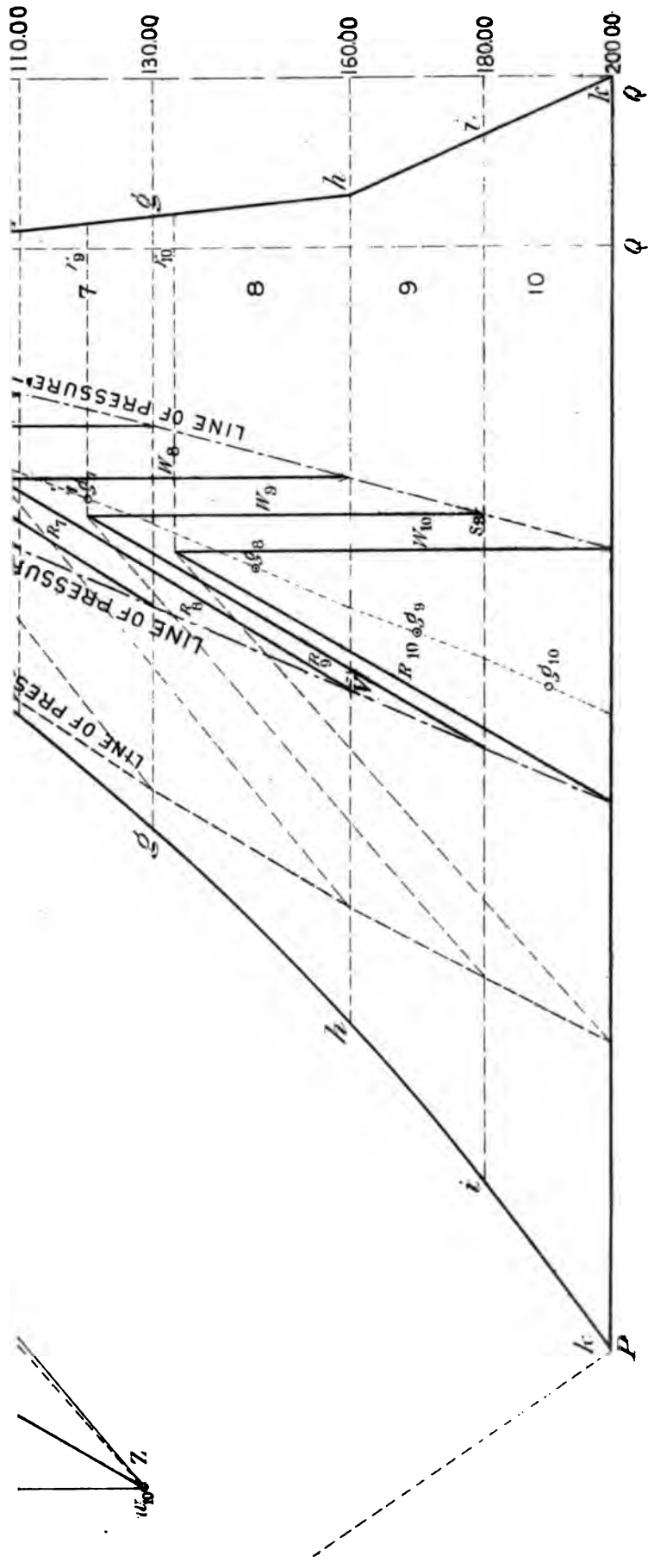
PRACTICAL PROFILE No. 3

SCALE OF FEET  
 0 5 10 15 20 40 60





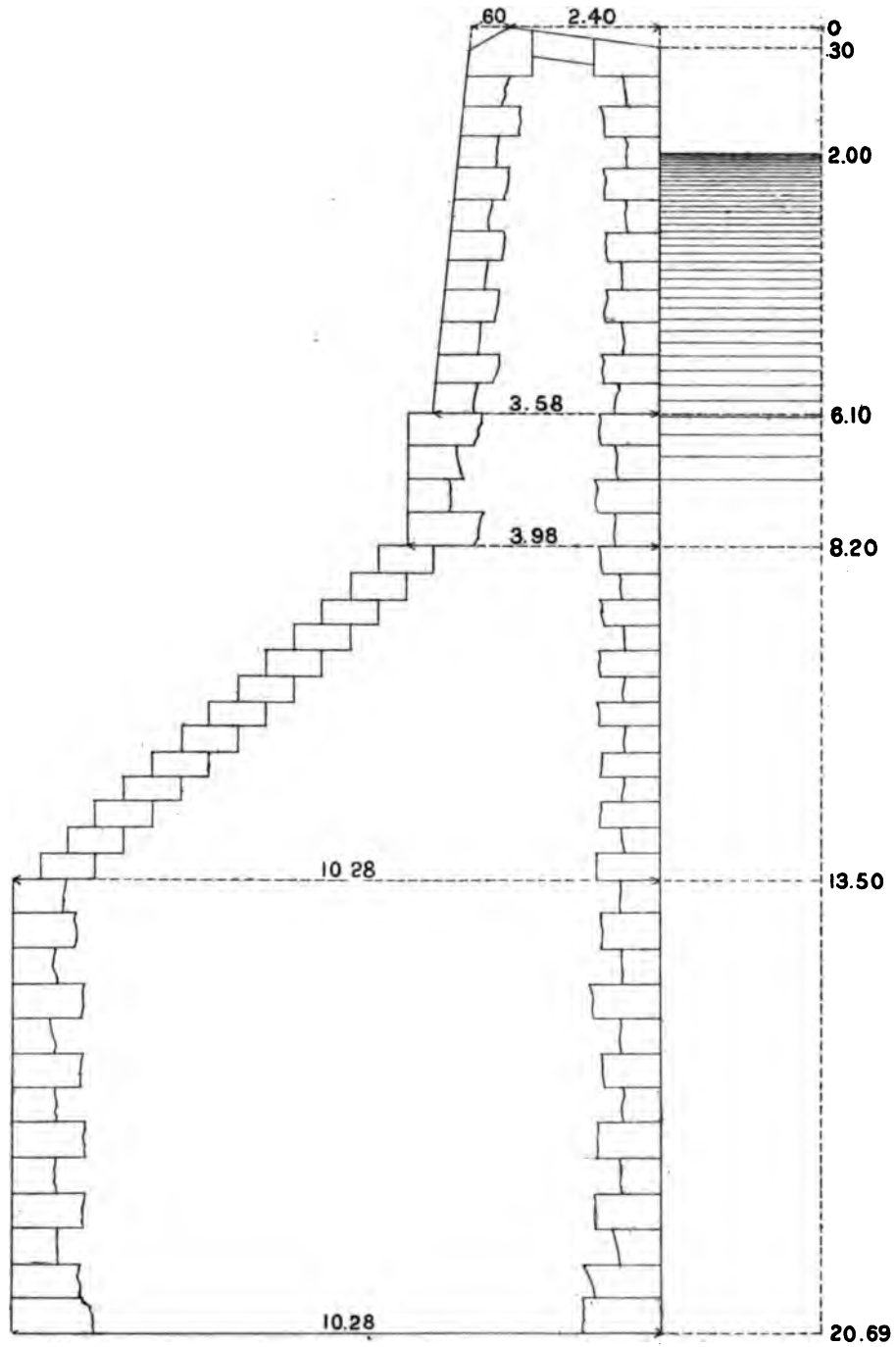
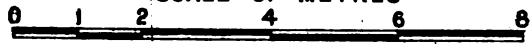
STABILITY OF PRACTICAL PROFILE No. 3  
FOUND BY  
GRAPHIC STATICS

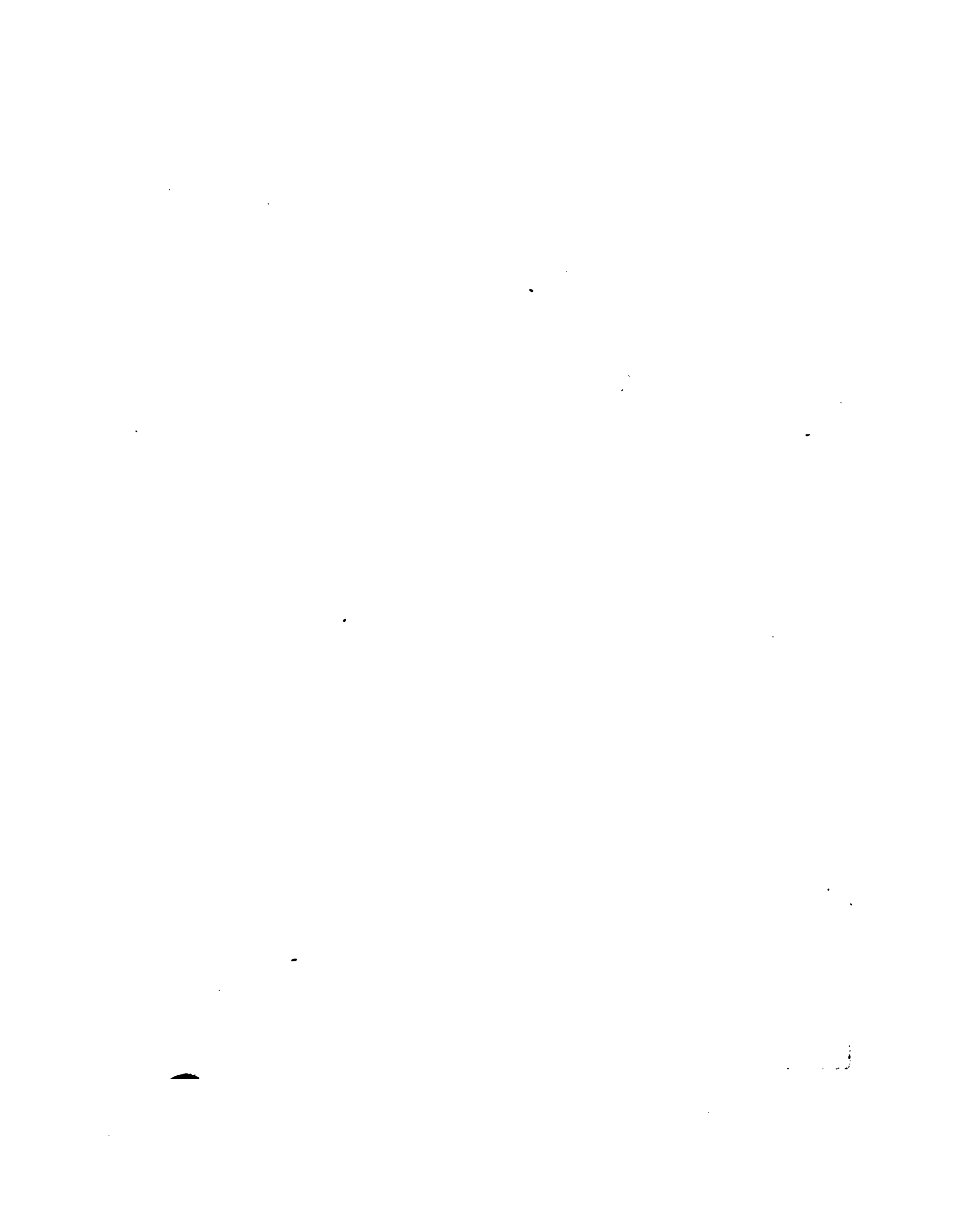




# ALMANZA DAM

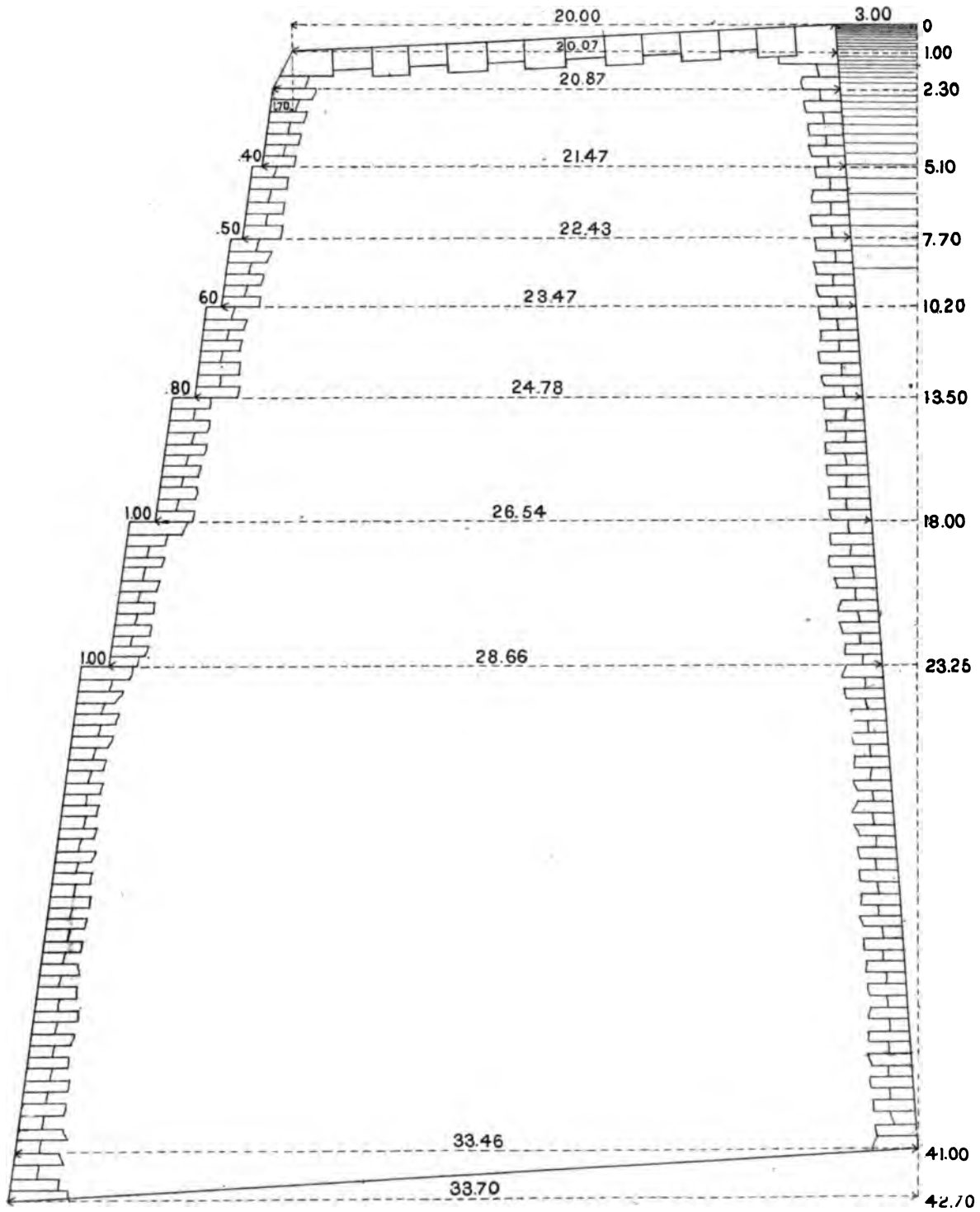
SCALE OF METRES

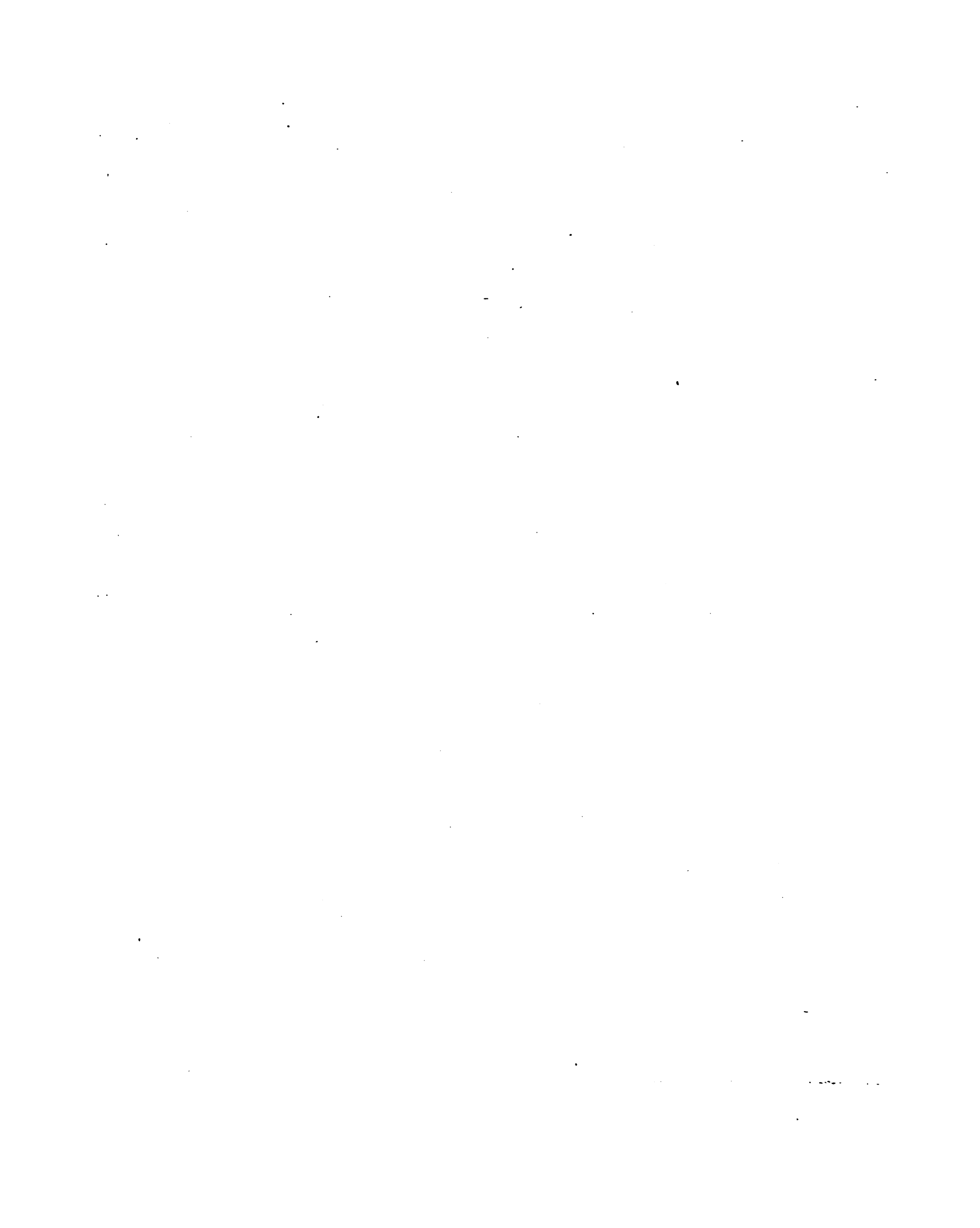




# ALICANTE DAM

SCALE OF METRES

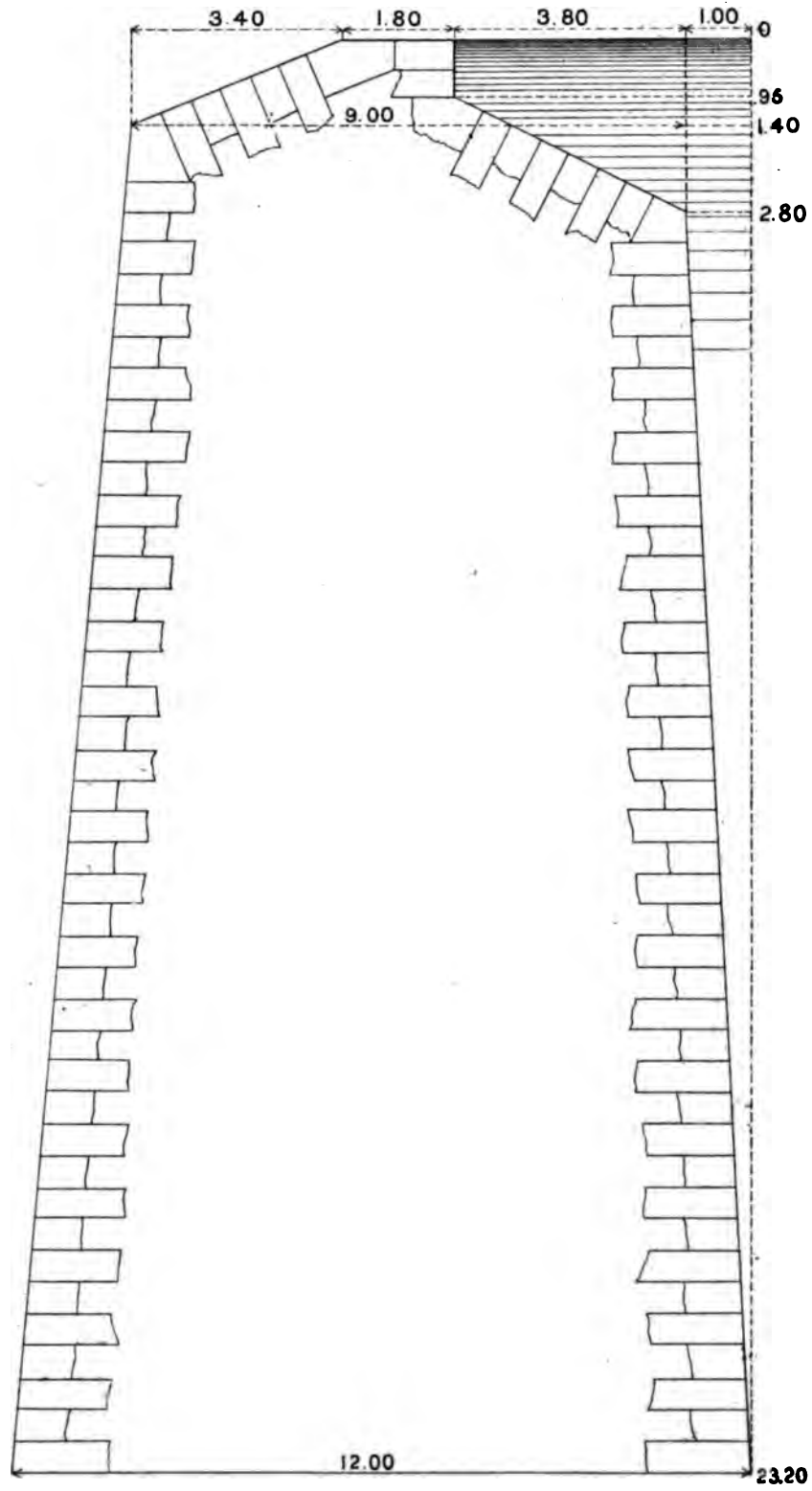
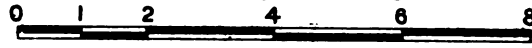






# ELCHE DAM

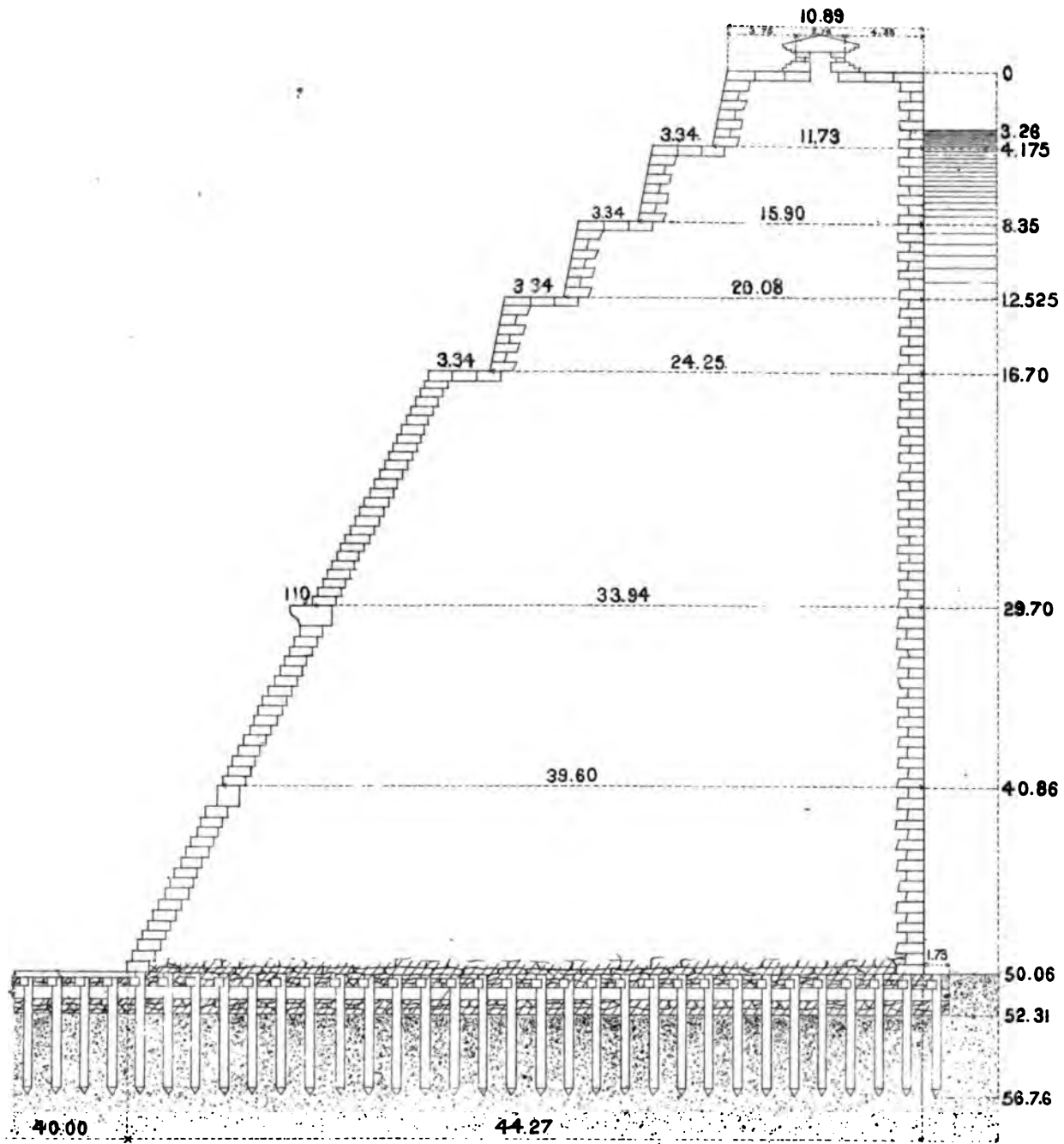
SCALE OF METRES





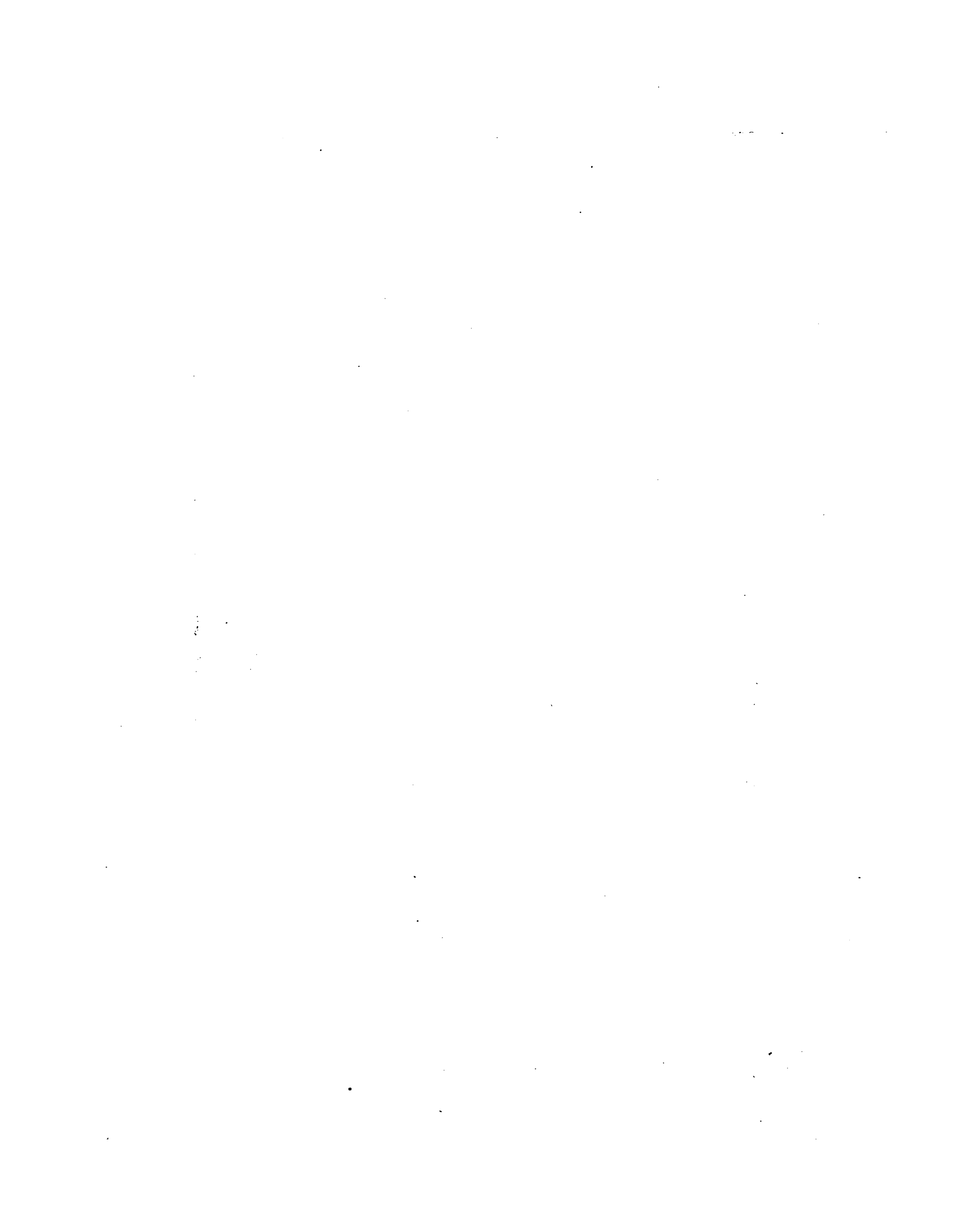
# PUENTES DAM

SCALE OF METRES  
0 1 2 4 6 8 10



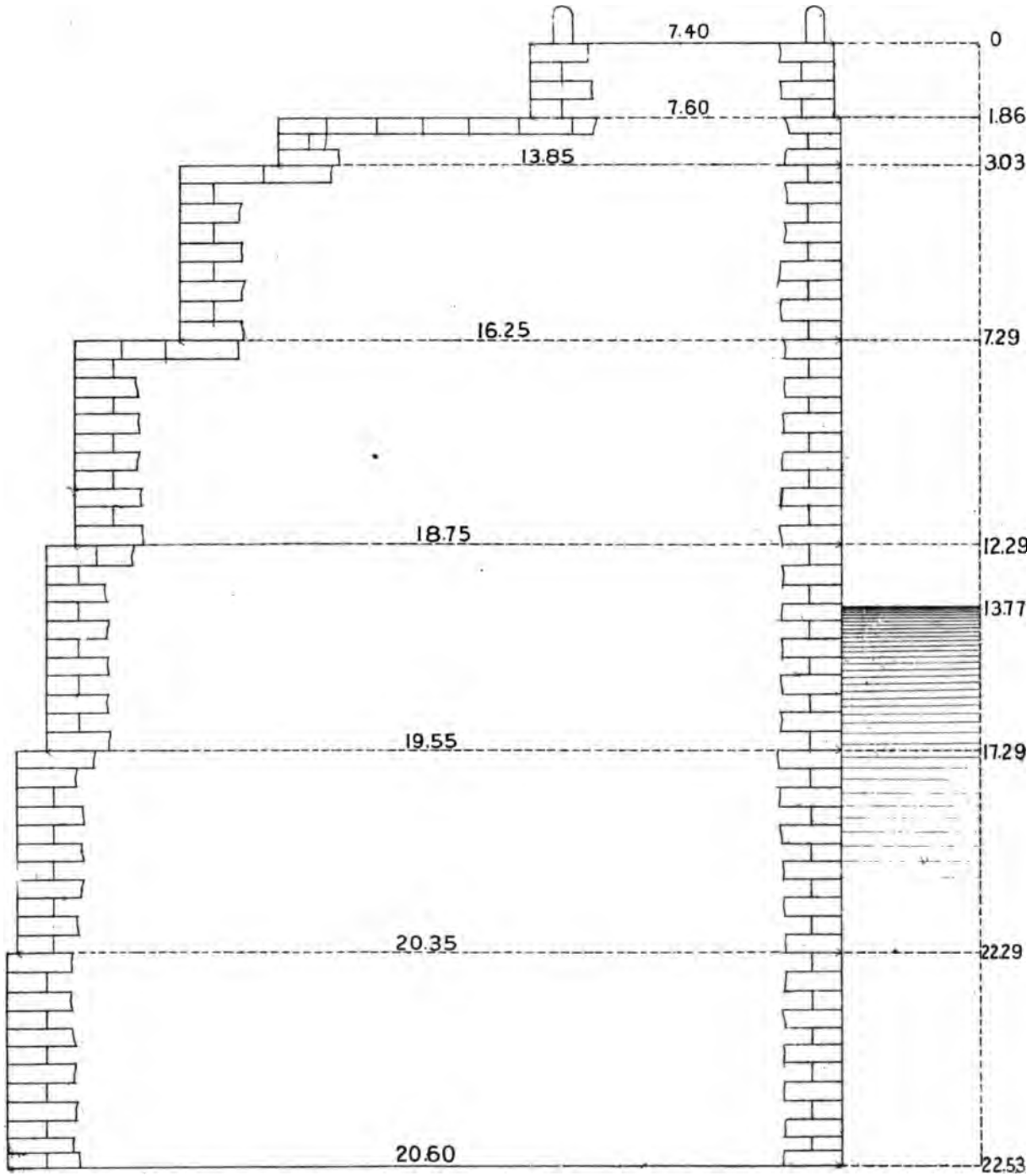
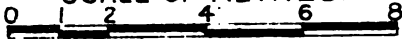
|





# NIJAR DAM

SCALE OF METRES.

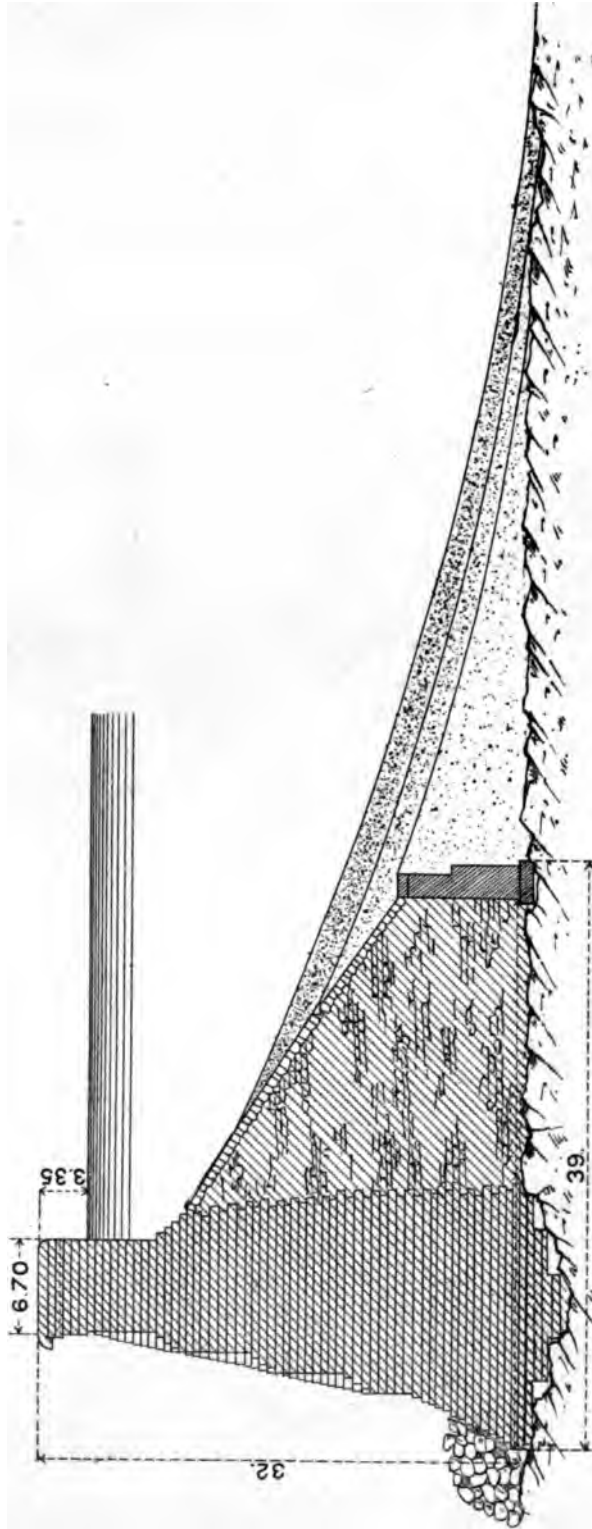
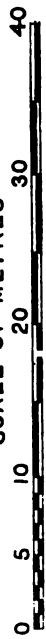


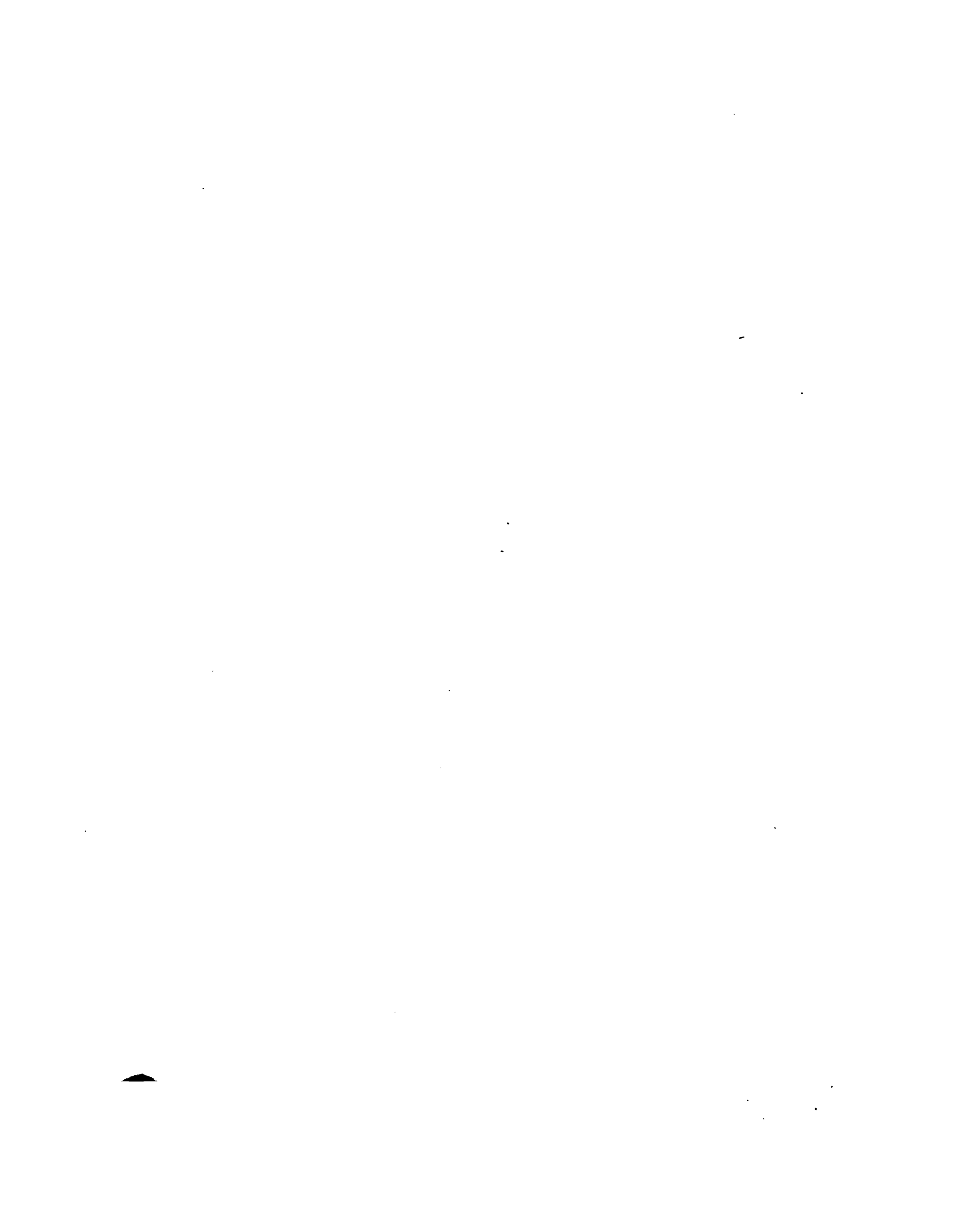




LOZOYA DAM

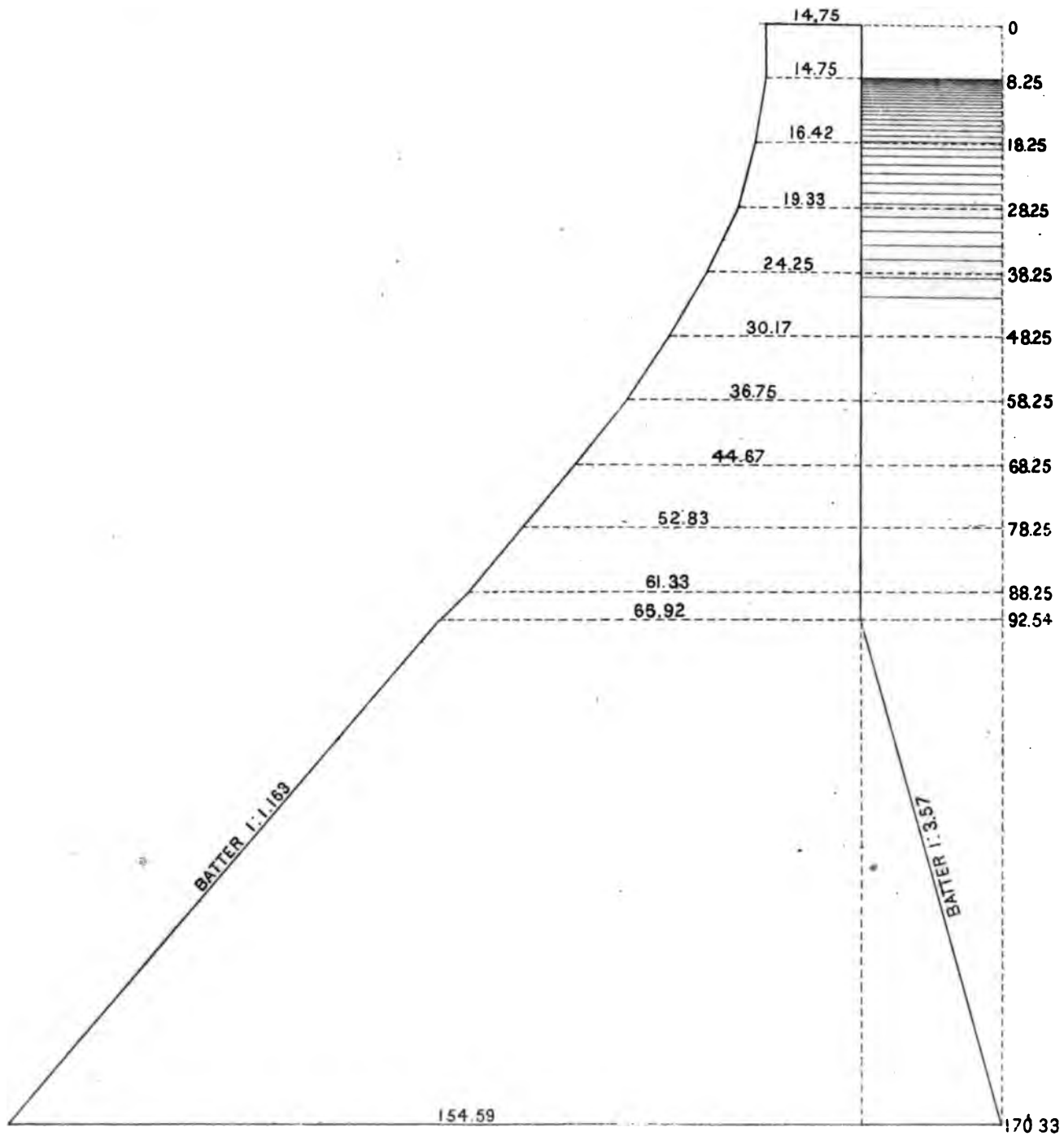
SCALE OF METRES





# VILLAR DAM

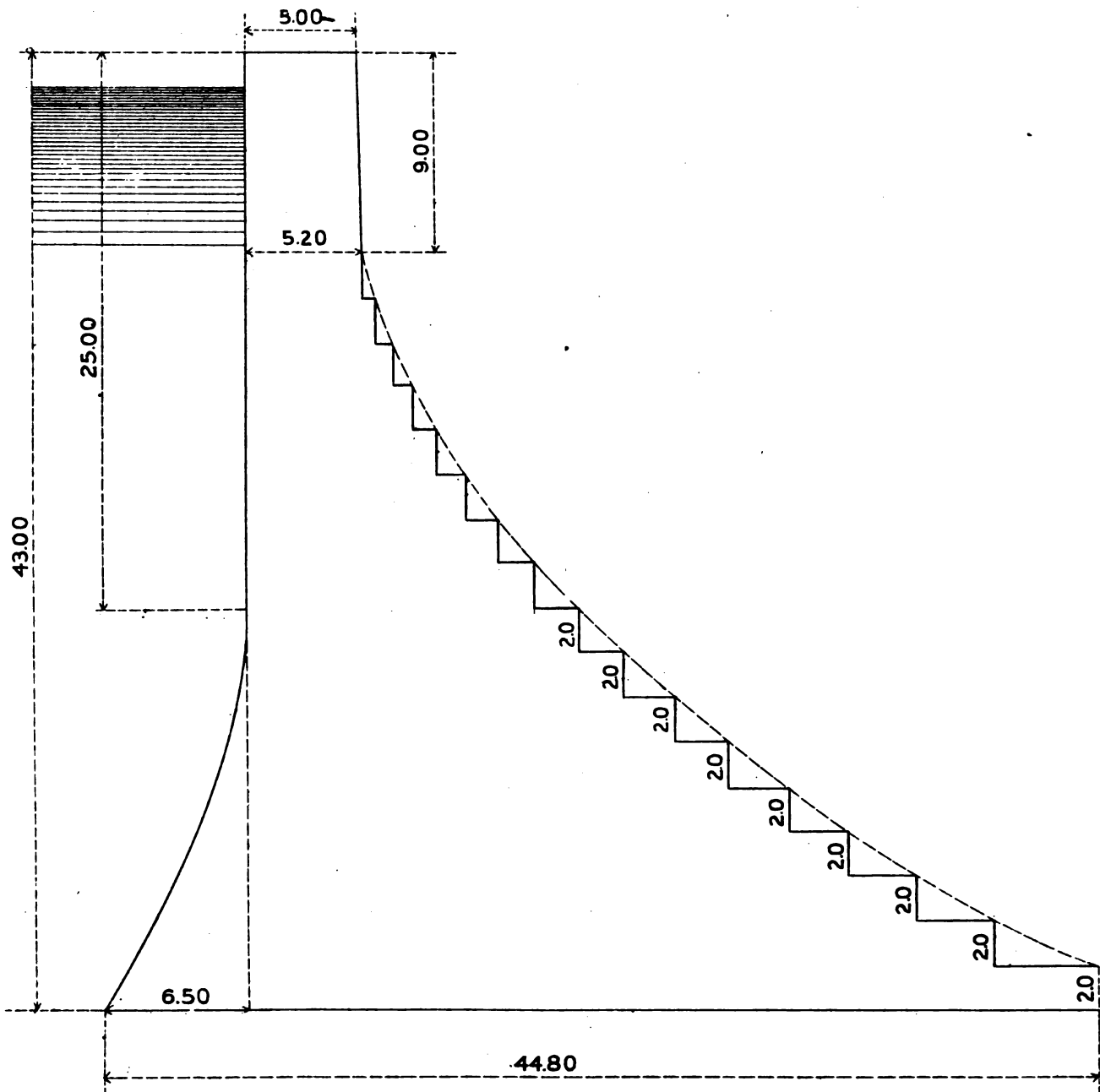
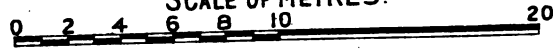
SCALE OF FEET  
0 5 10 20 30

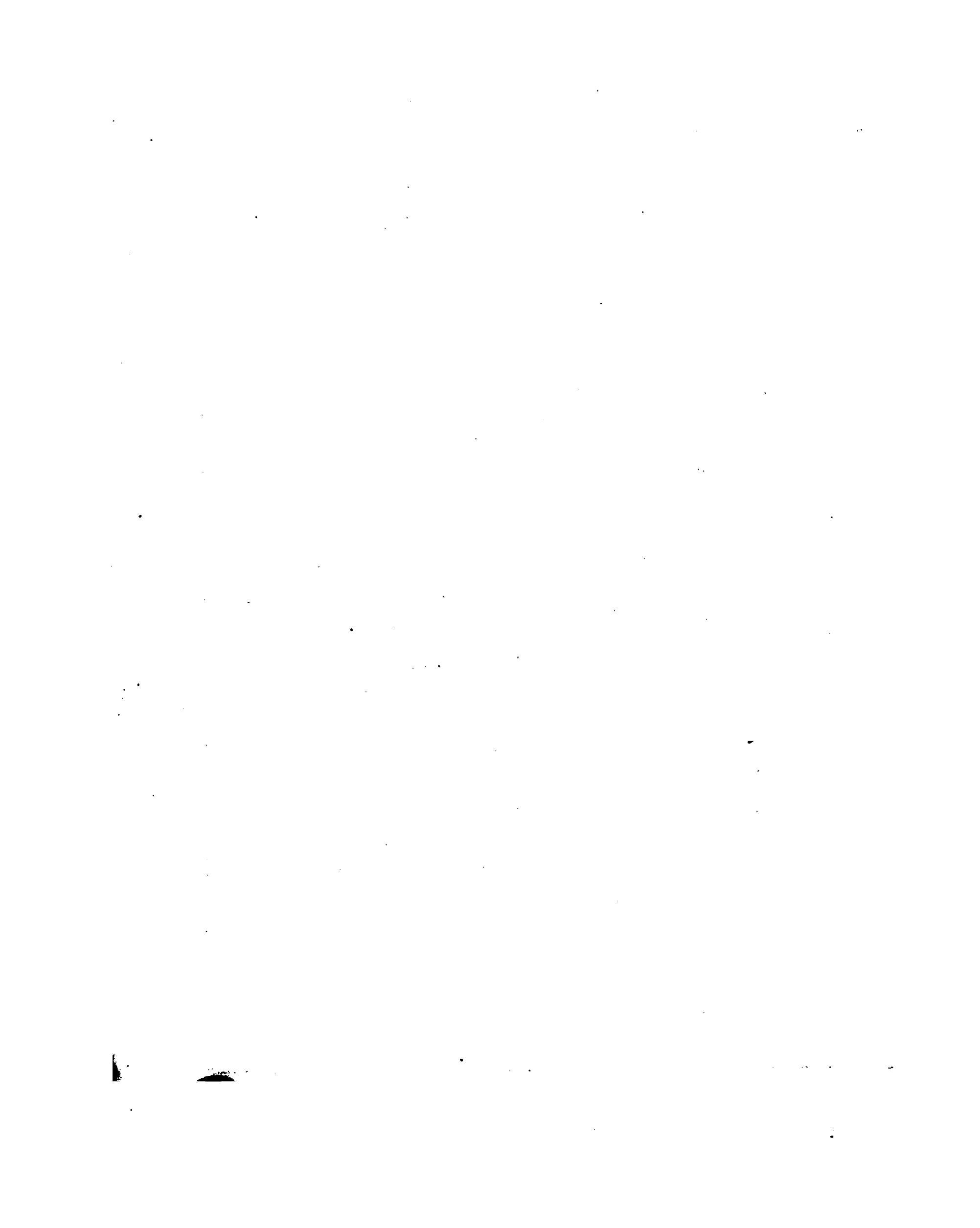


7

# HIJAR DAM

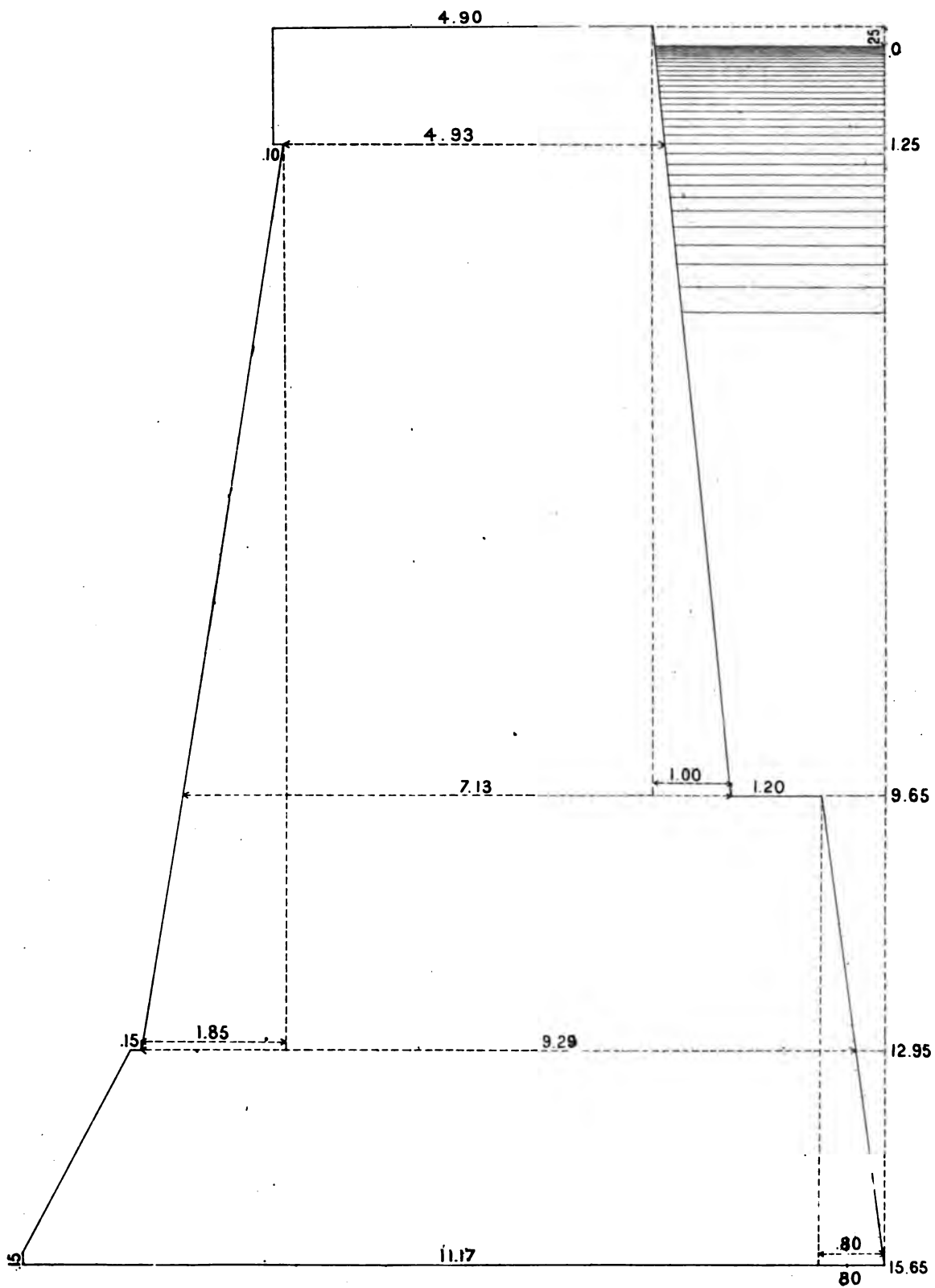
SCALE OF METRES.





# LAMPY DAM

SCALE OF METRES

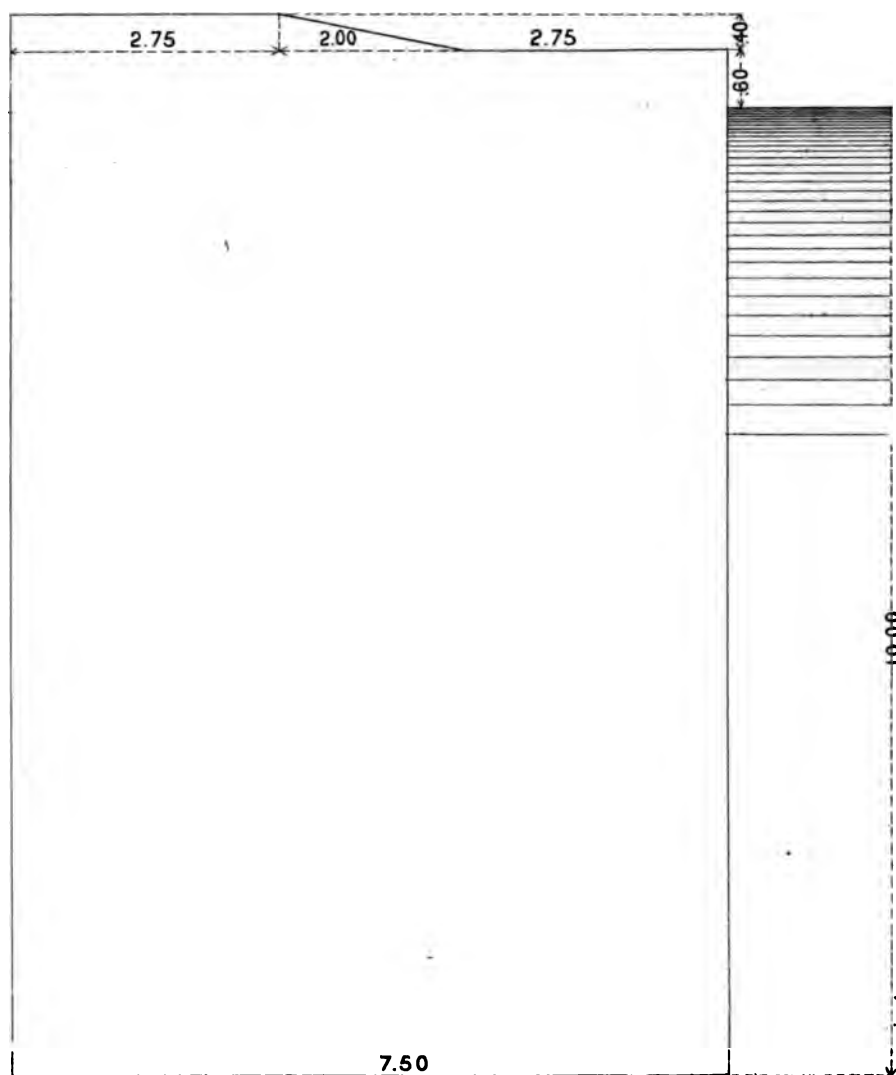






# VIOREU DAM

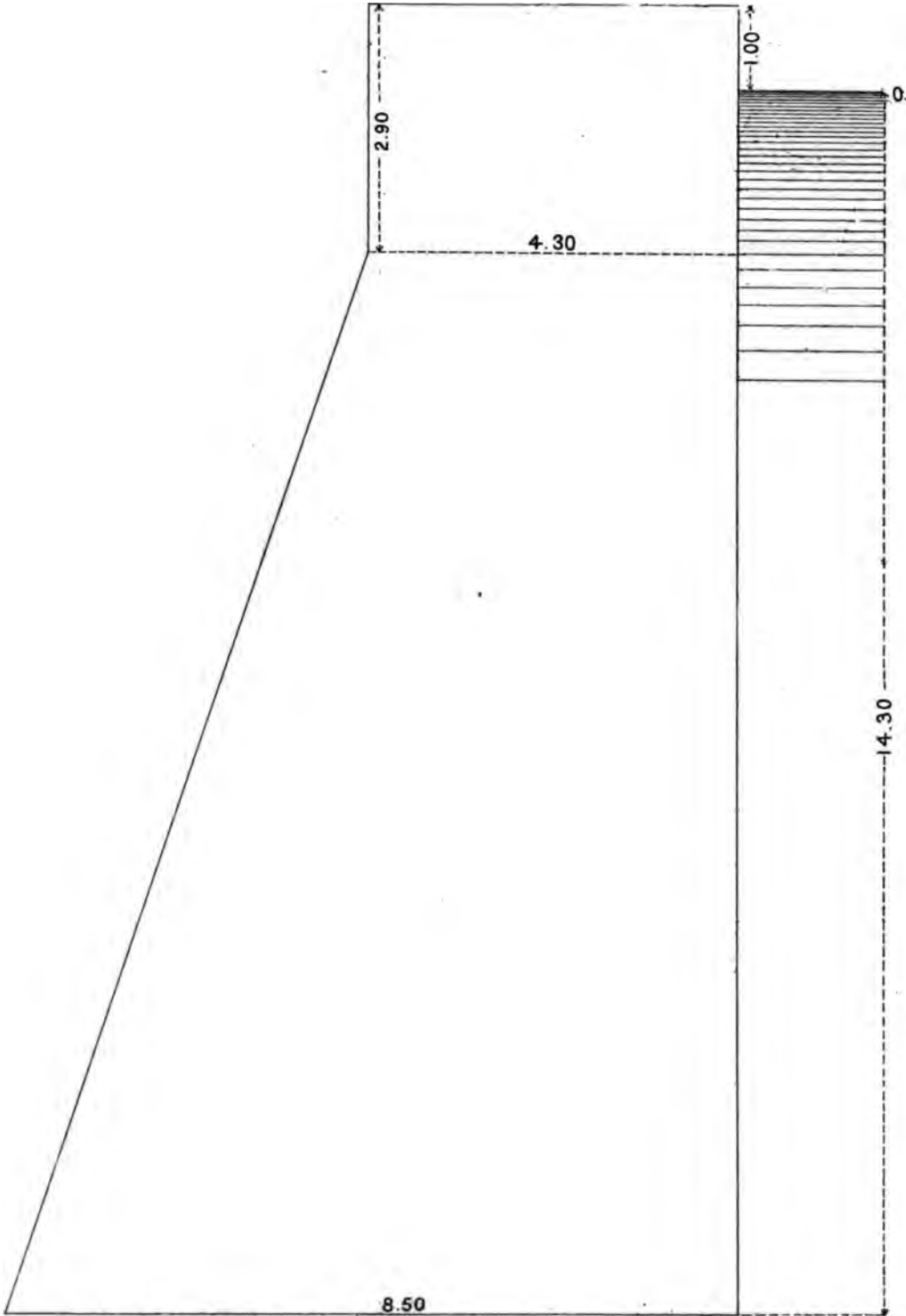
SCALE OF METRES





# BOSMELEA DAM

SCALE OF METRES



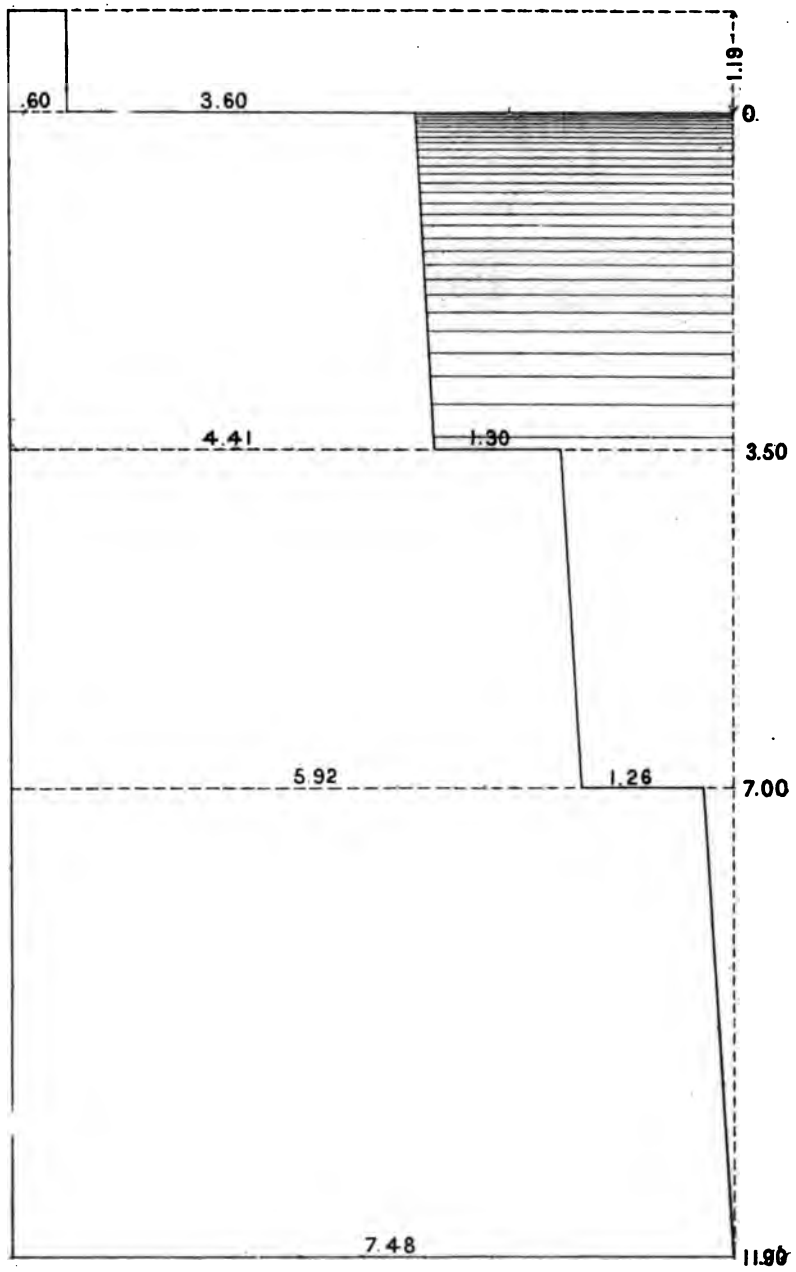
|

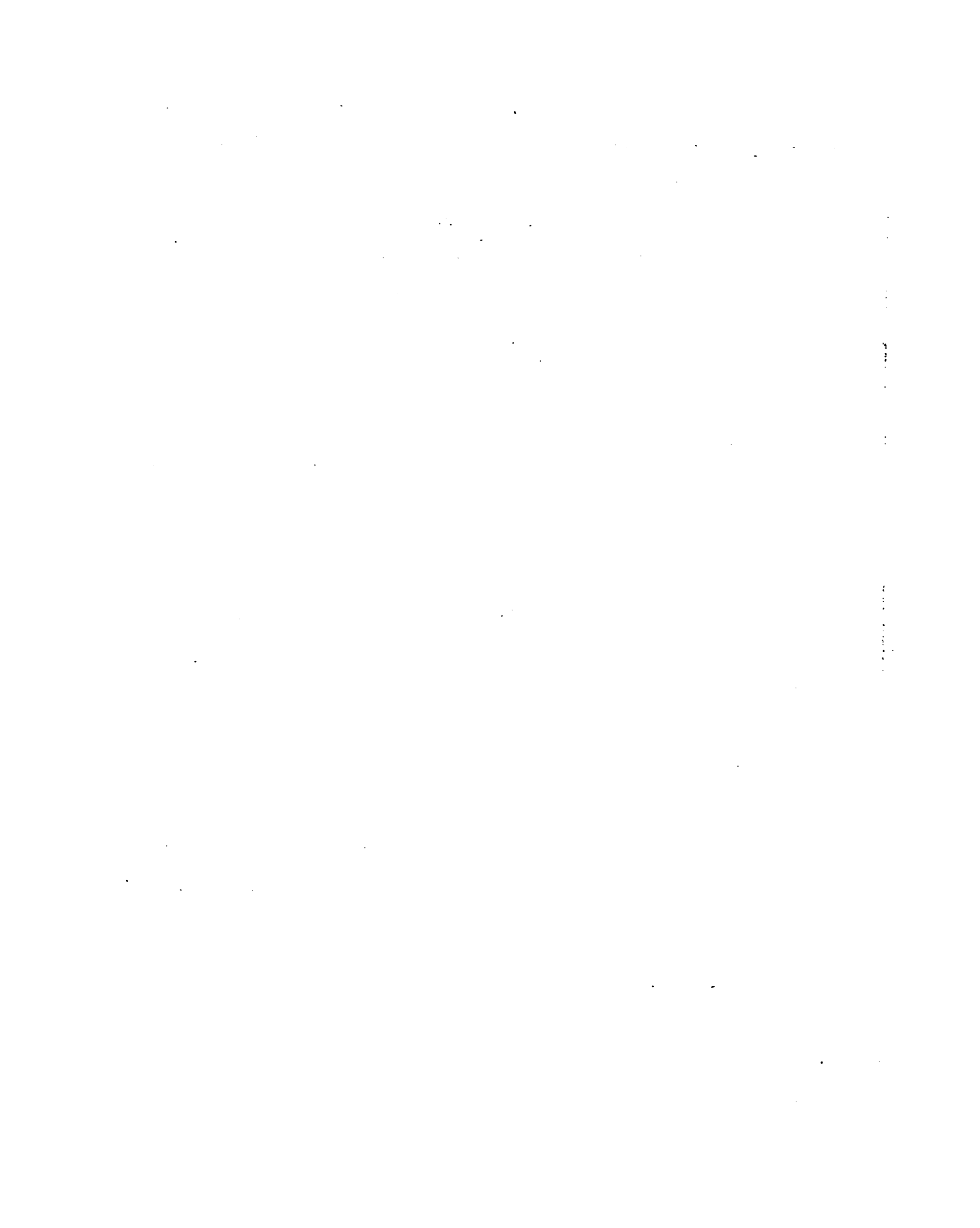
■



# GLOMEL DAM

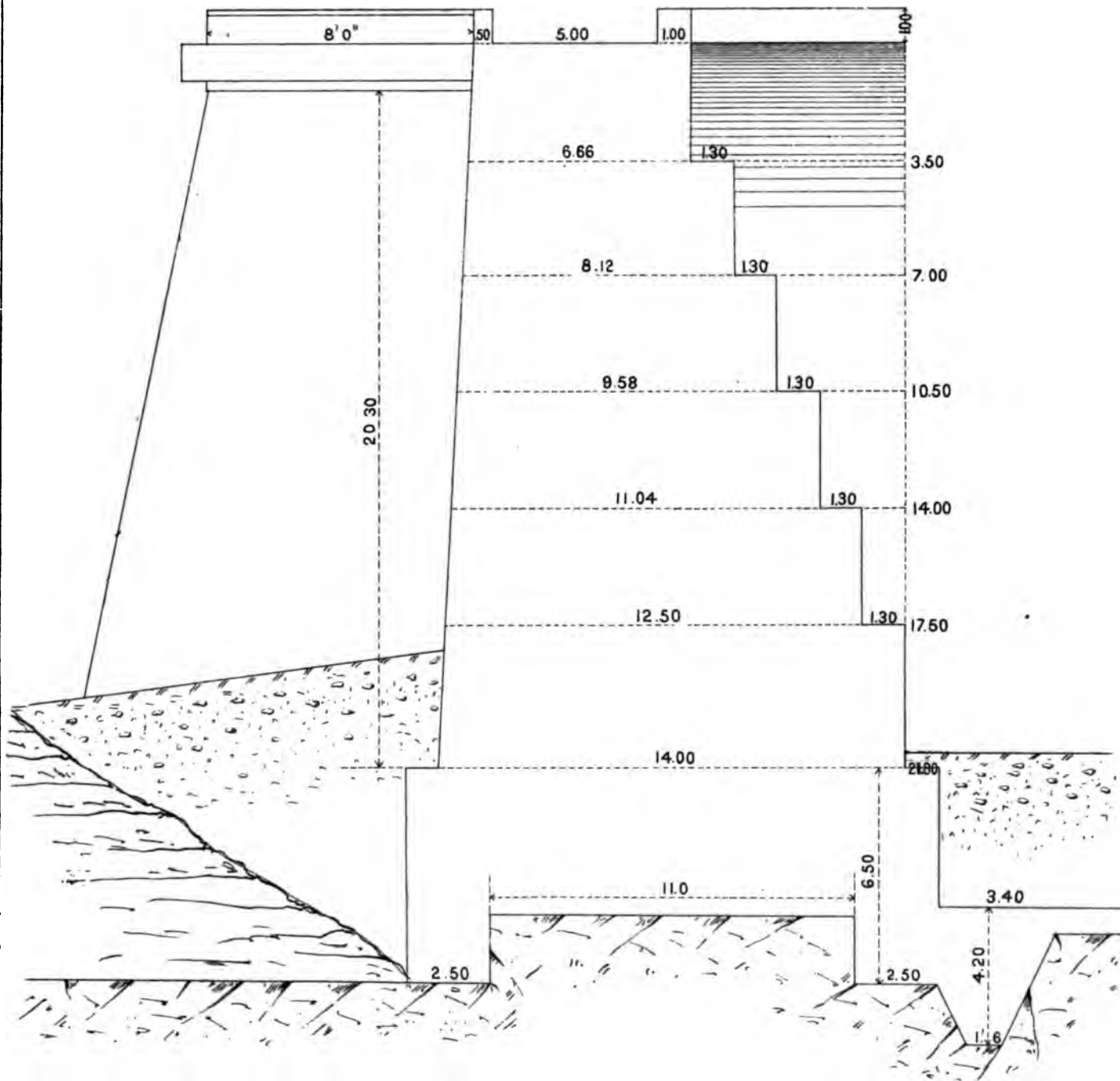
SCALE OF METRES





# GROS-BOIS DAM

SCALE OF METRES

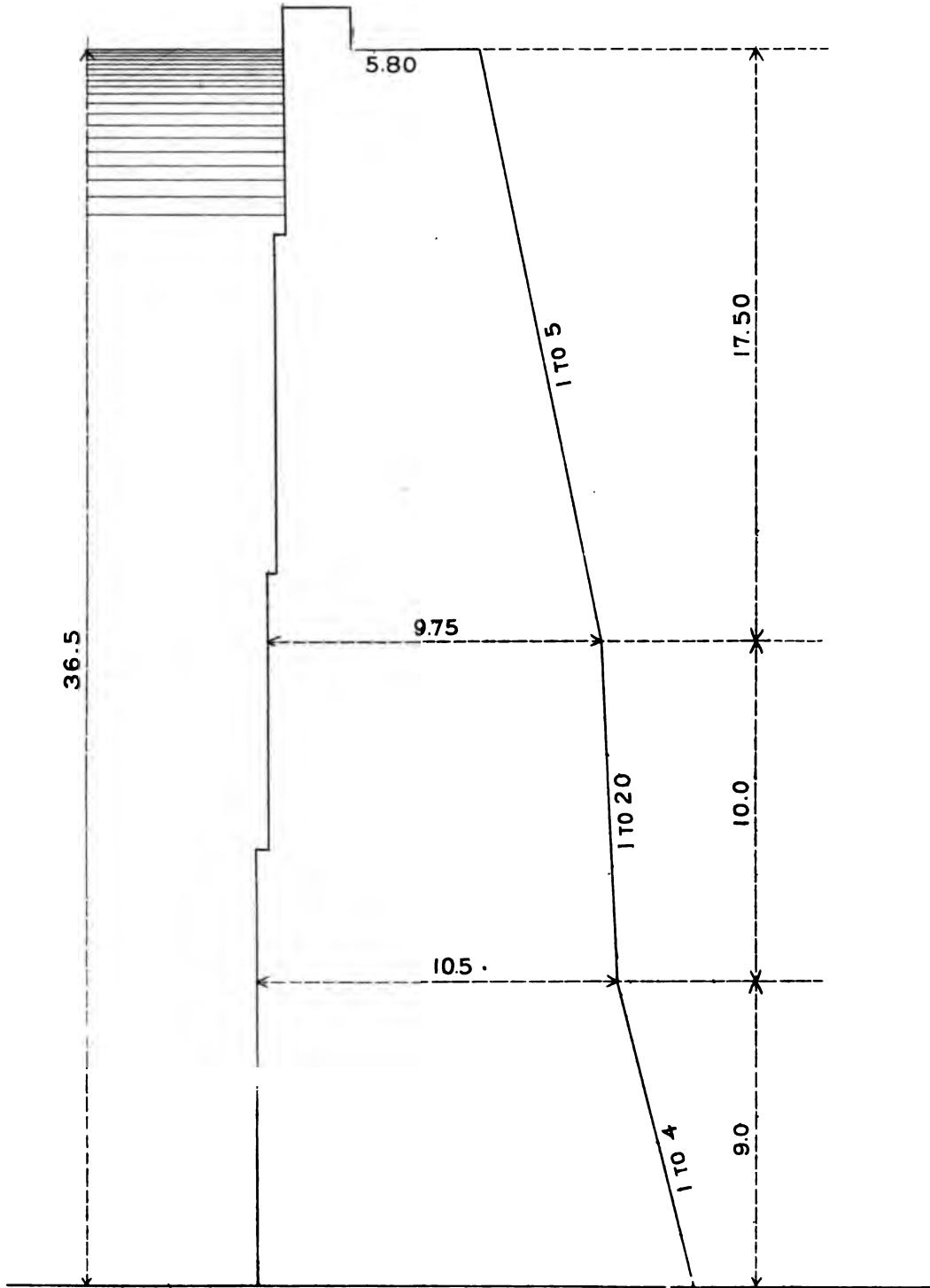






# ZOLA DAM

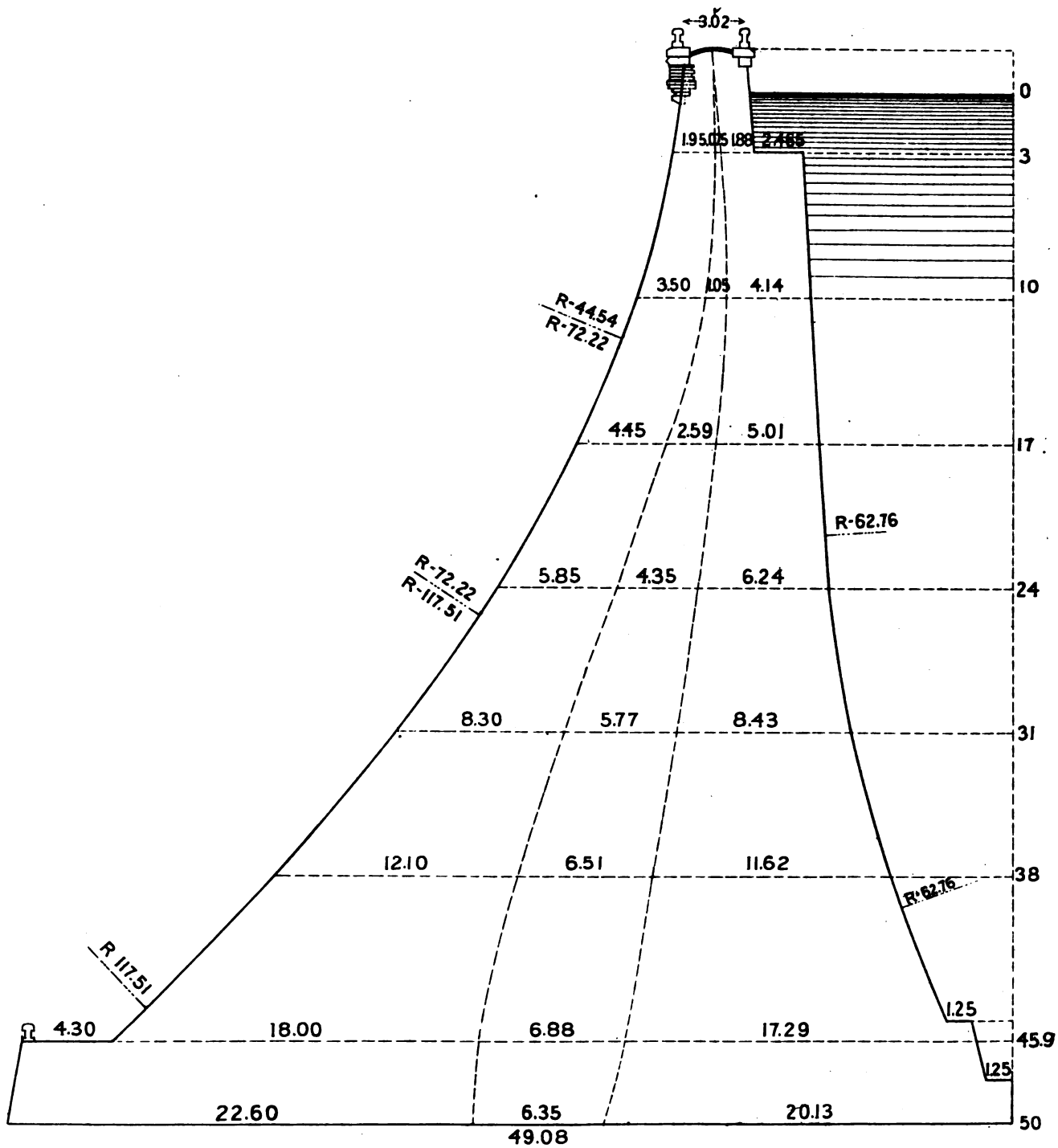
SCALE OF METRES.





# FUREN'S DAM

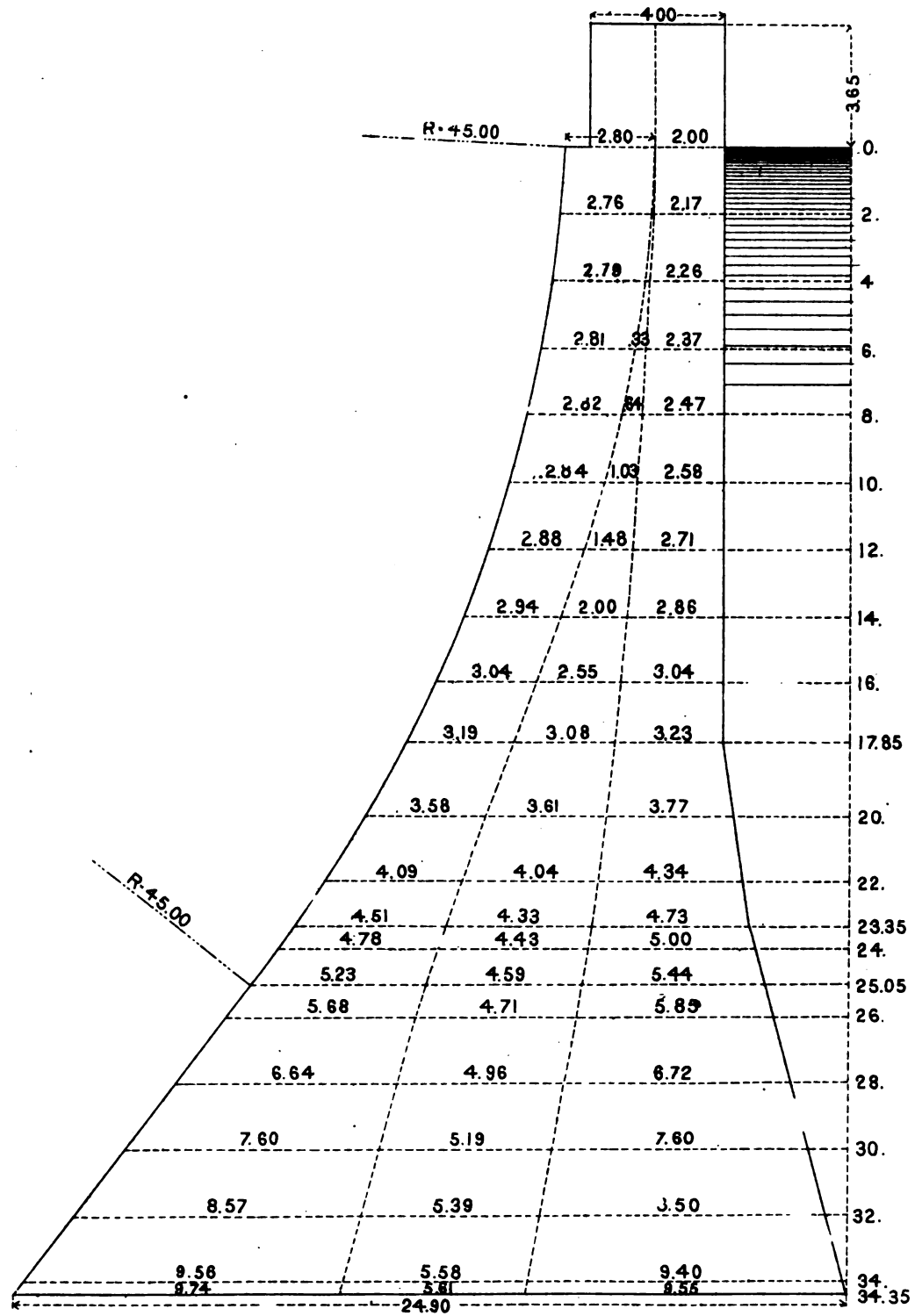
SCALE OF METRES.





# TERNAY DAM

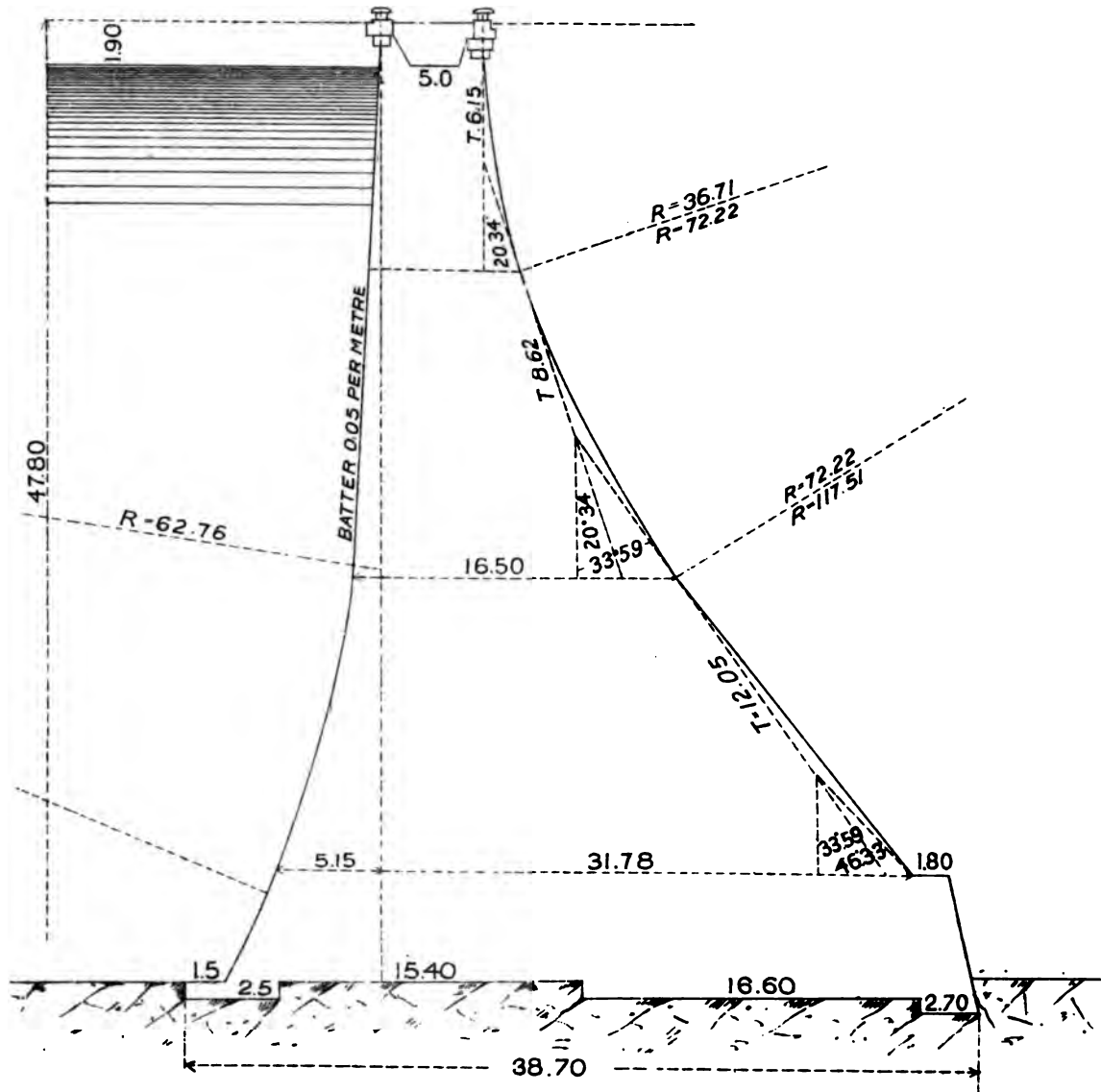
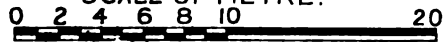
SCALE OF METRES  
0 1 2 4 6 8





# BAN DAM

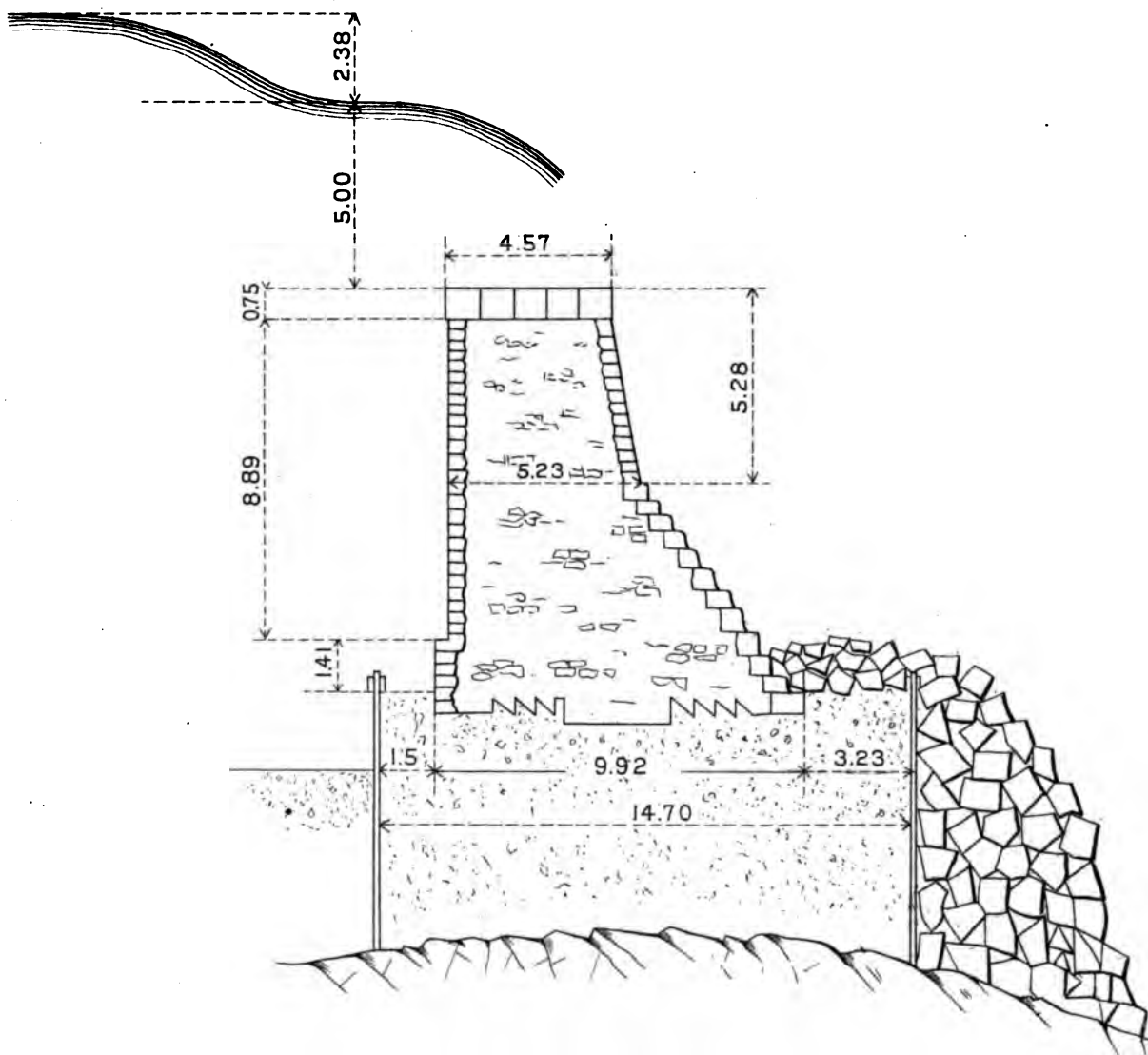
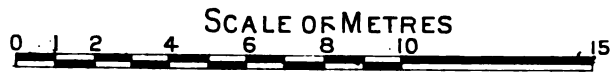
SCALE OF METRE.







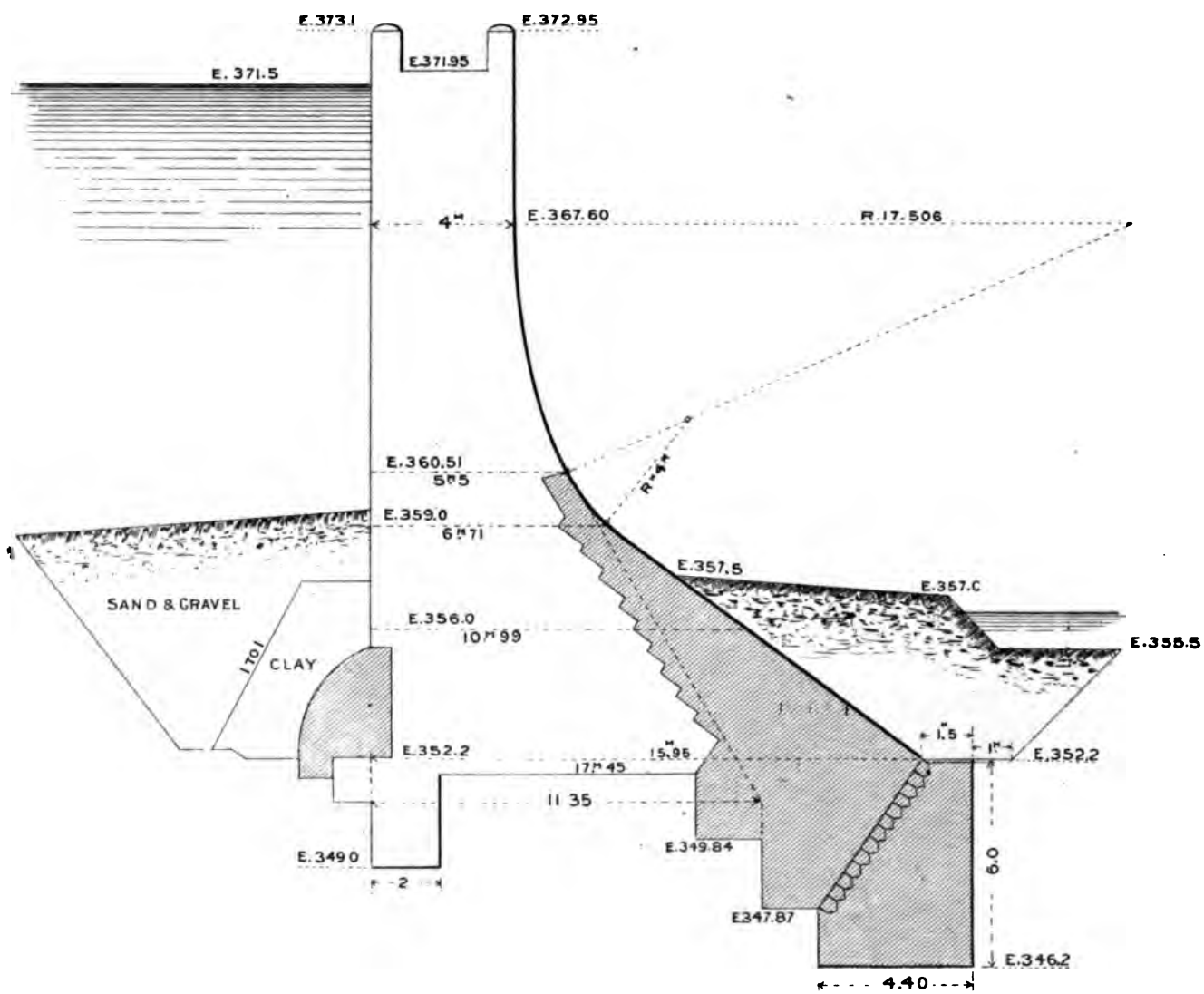
# VERDON DAM

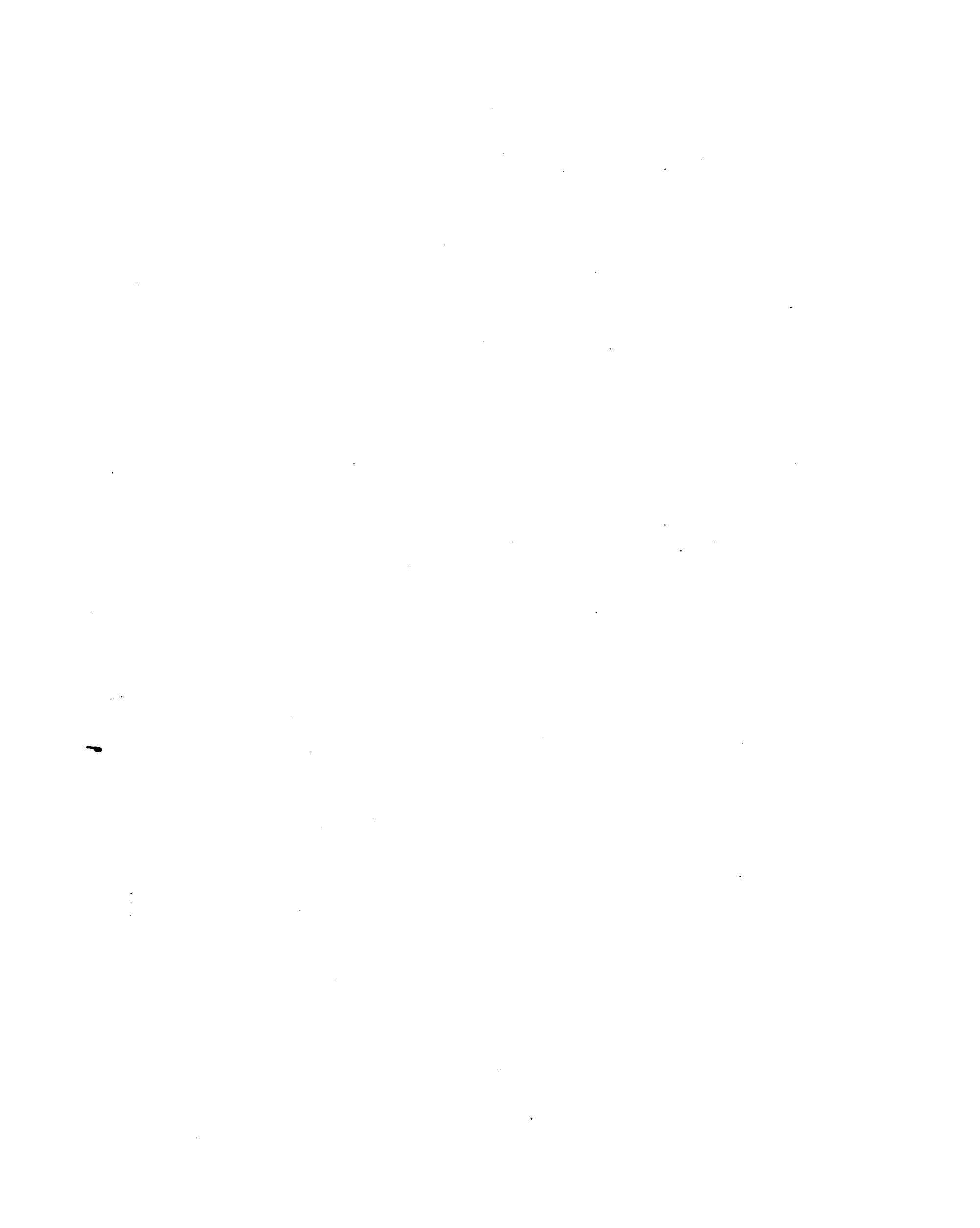




# BOUZEY DAM

SCALE OF METRES  
0 1 2 3 4 5 10





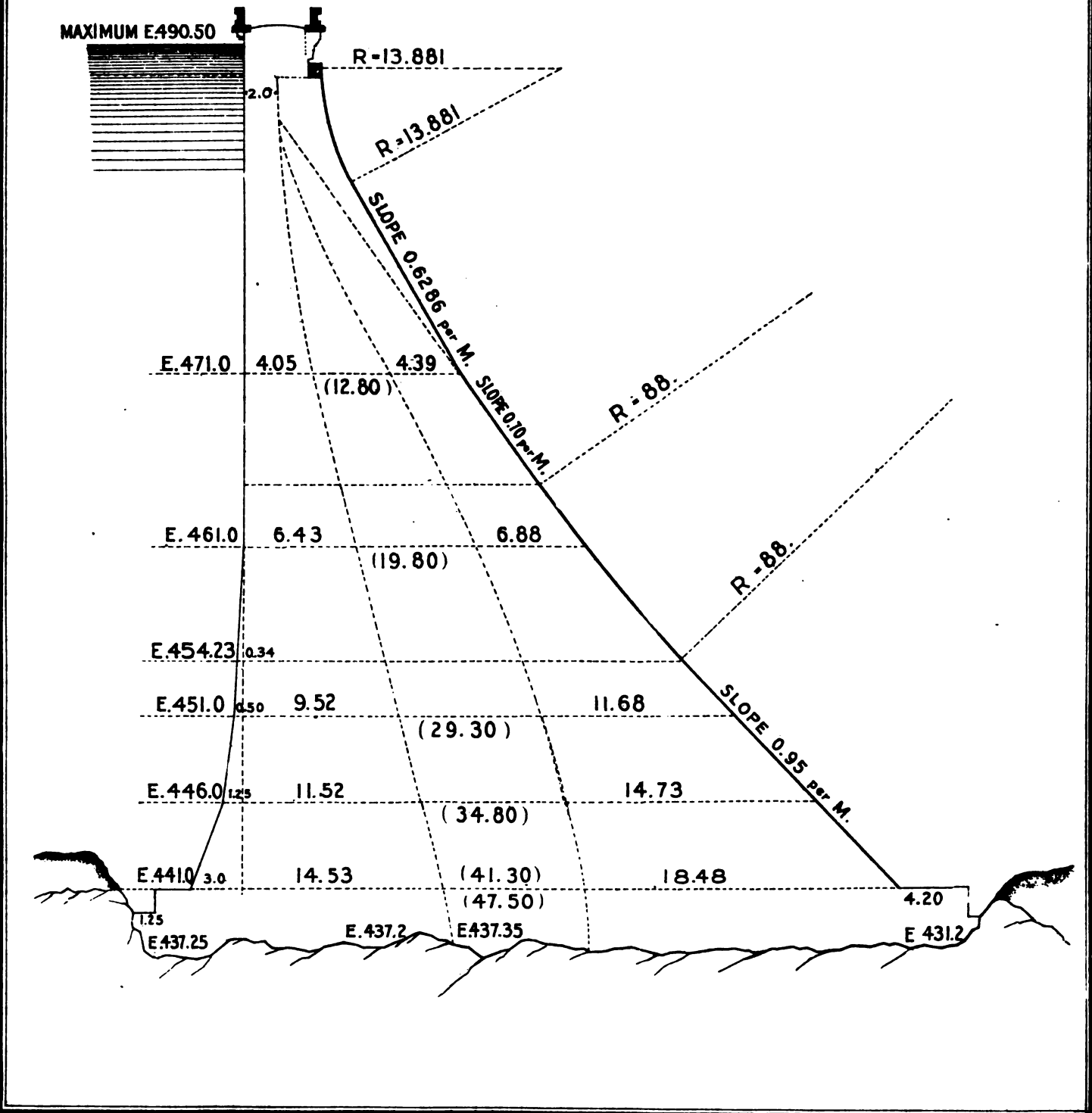




# CHATRAIN DAM

SCALE OF METRES.

0 1 2 3 4 5 10











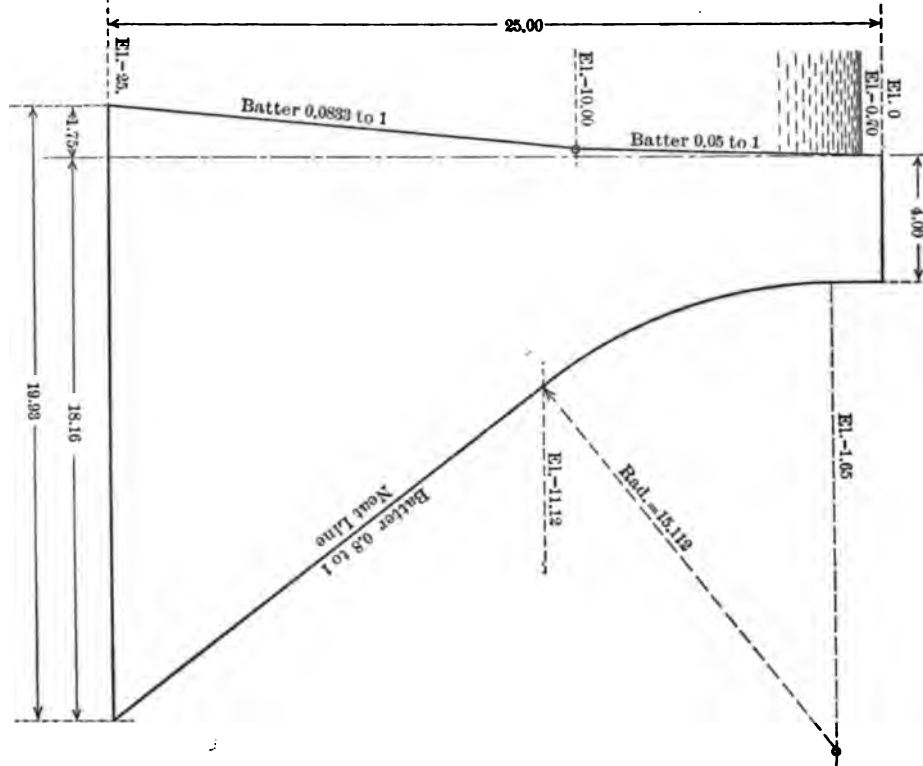


Fig. 1.—TURBINE DAM.

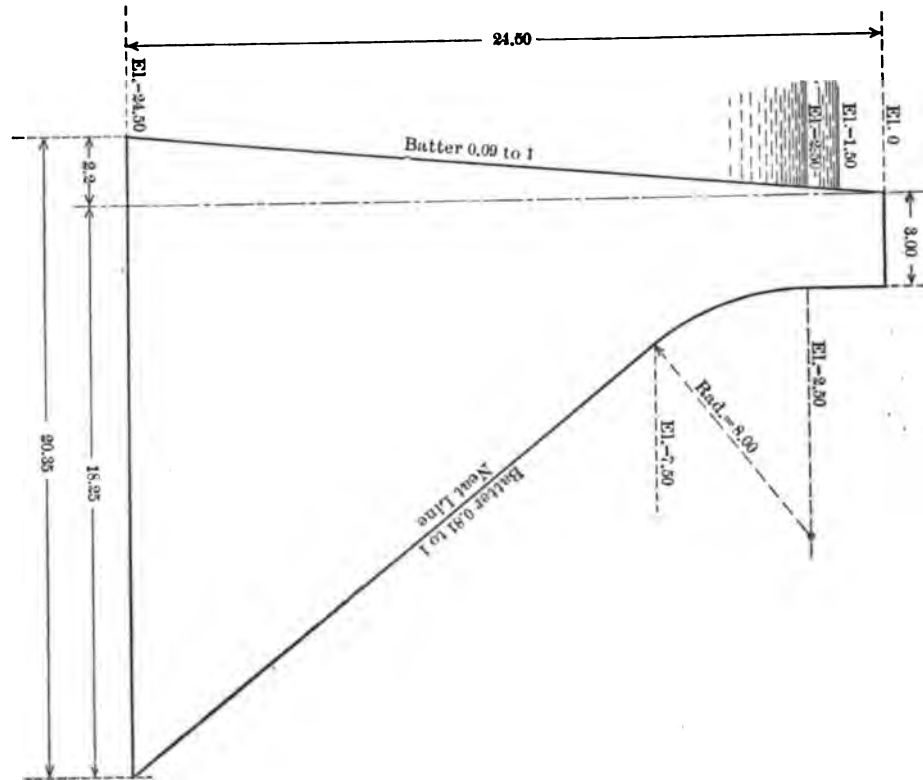
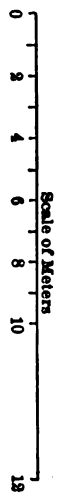
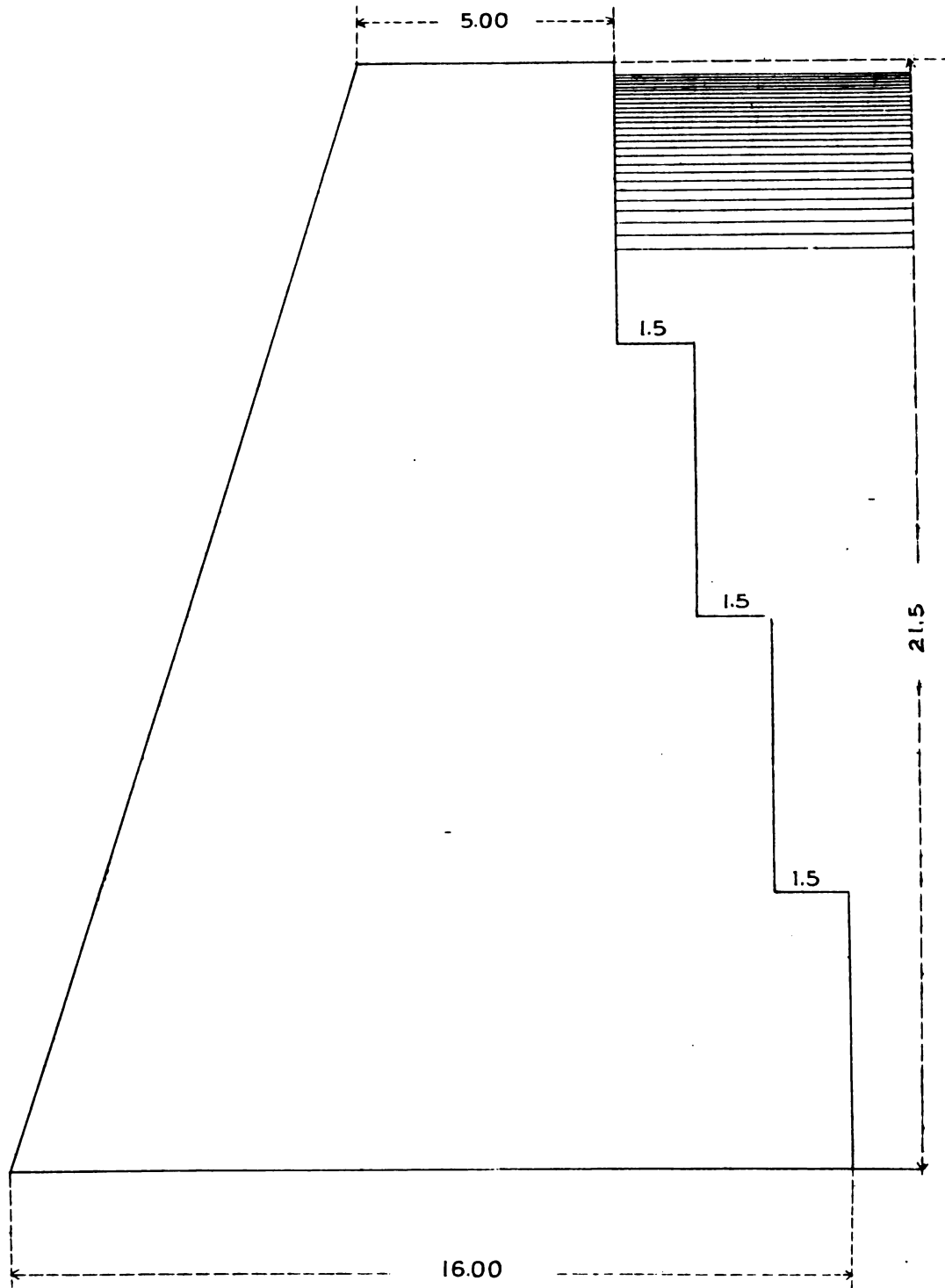
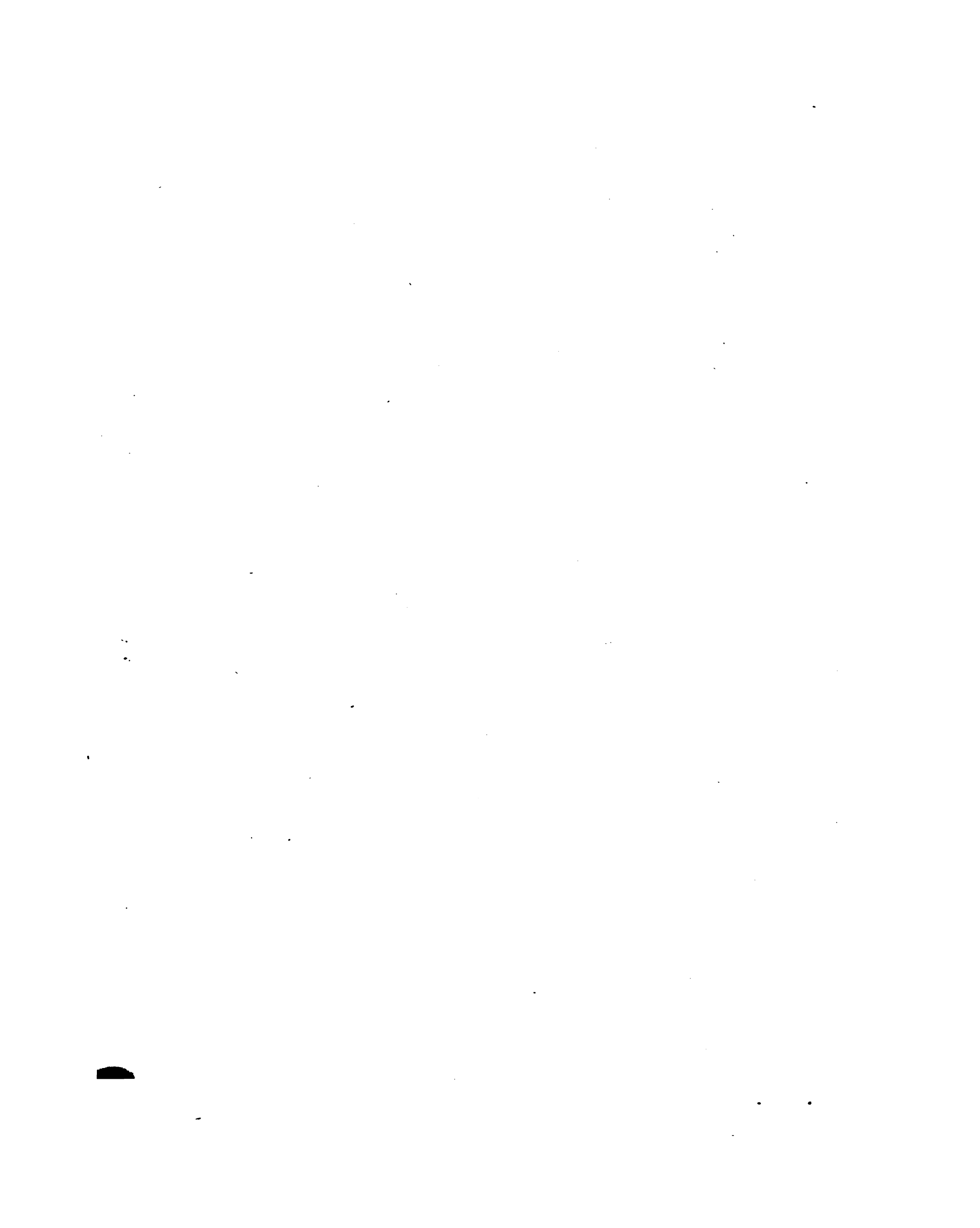


Fig. 2.—MODEREIX DAM.



# CAGLIARI DAM

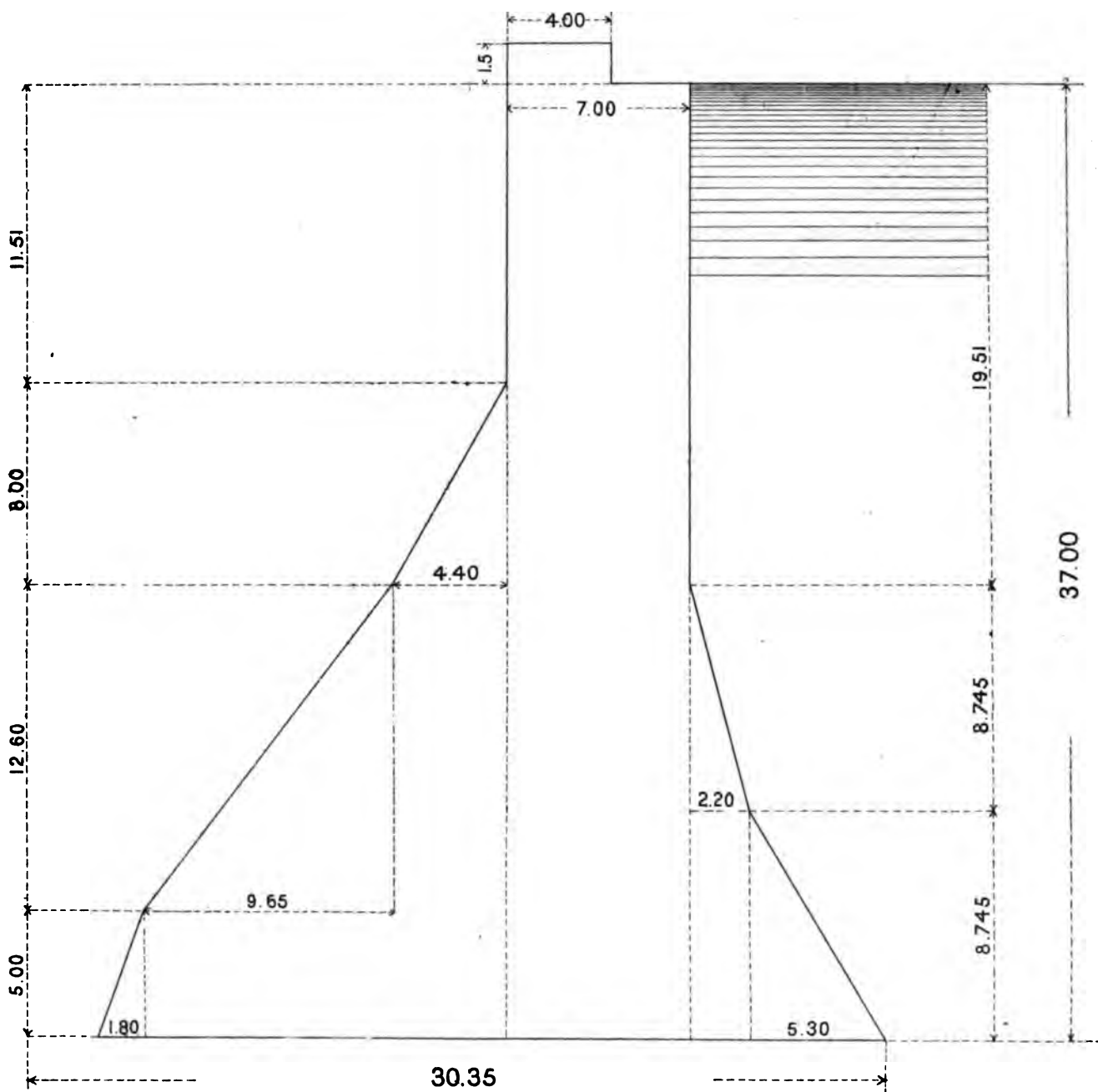




# GORZENTE DAM

SCALE OF METRES

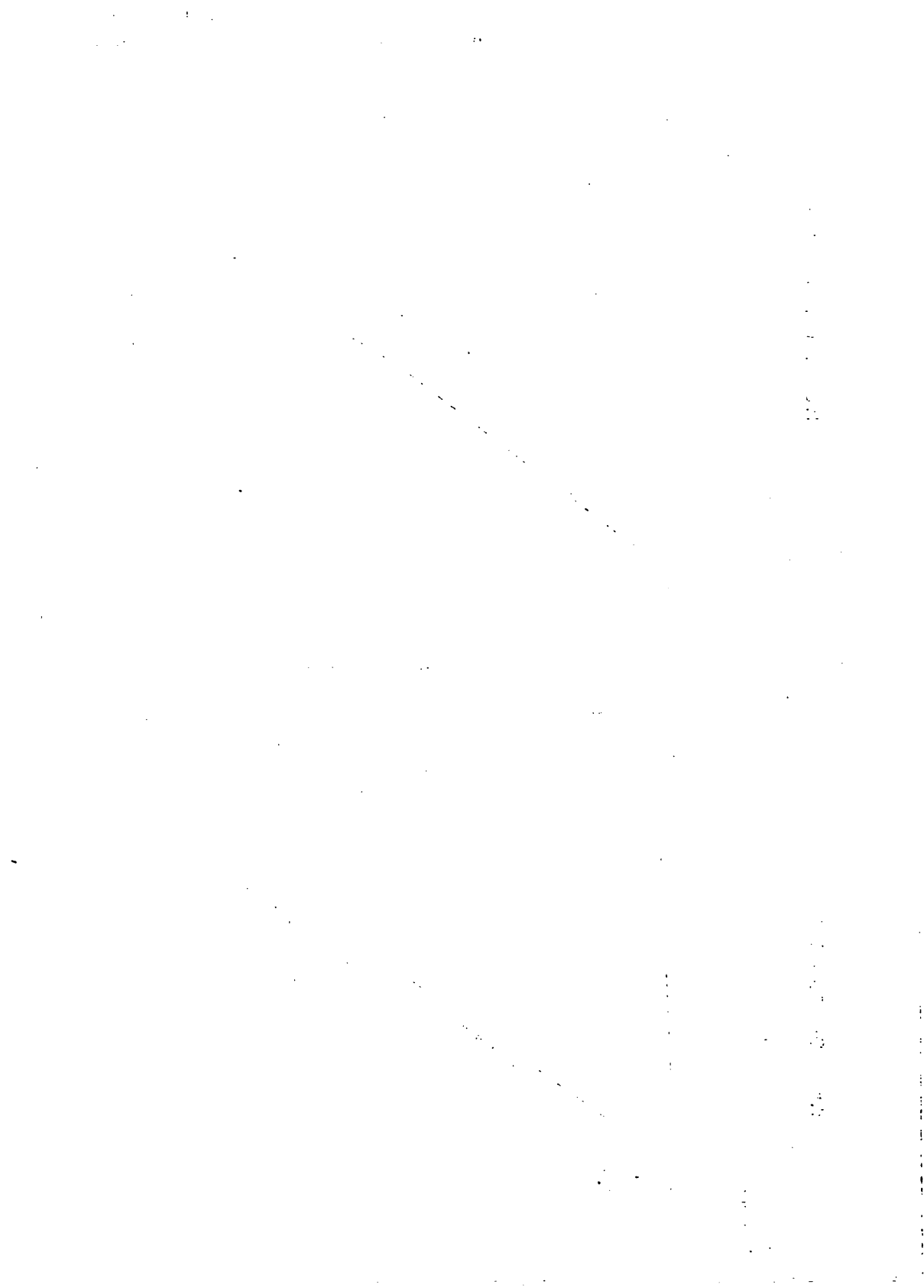
0 2 4 6 8 10 12

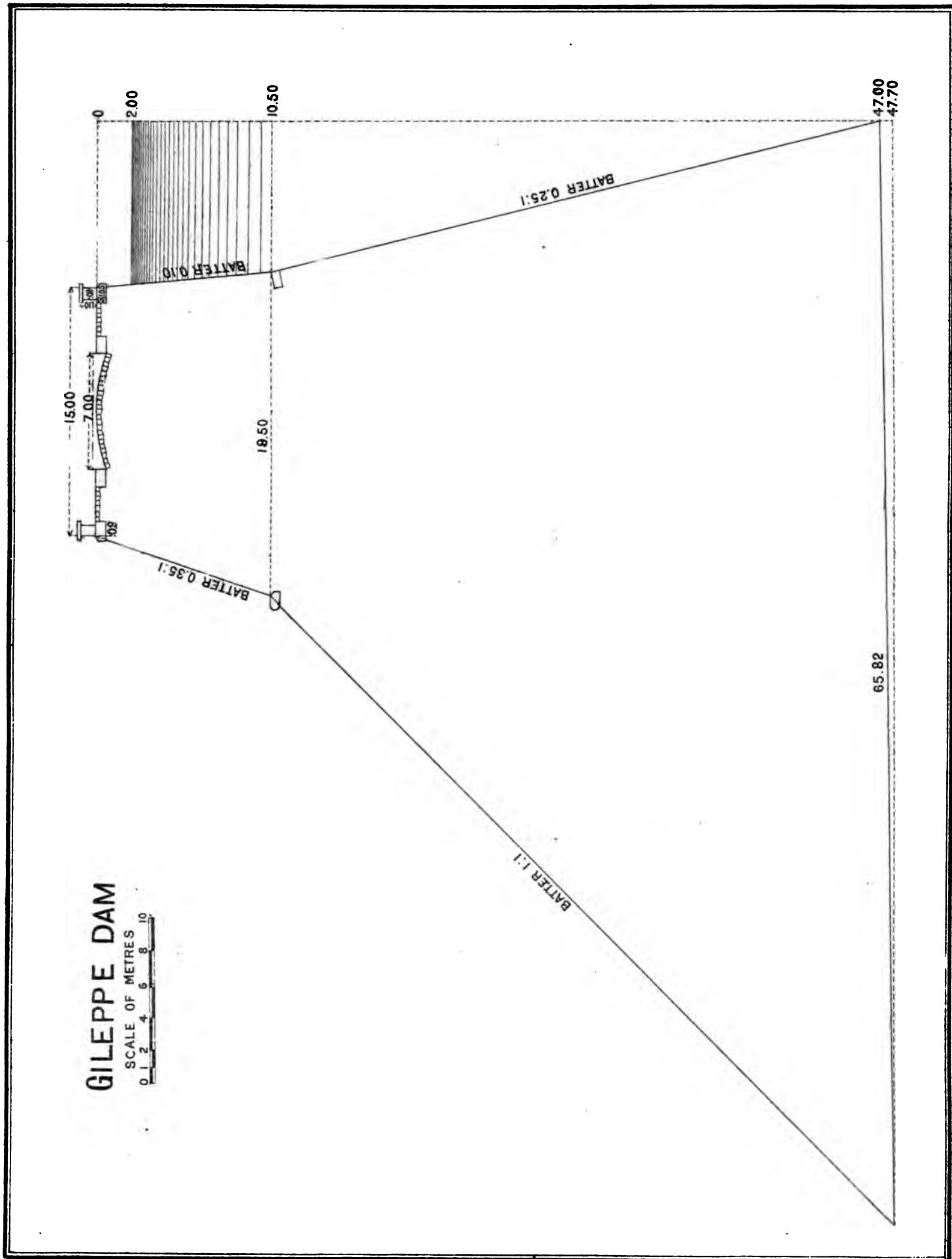


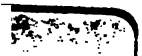




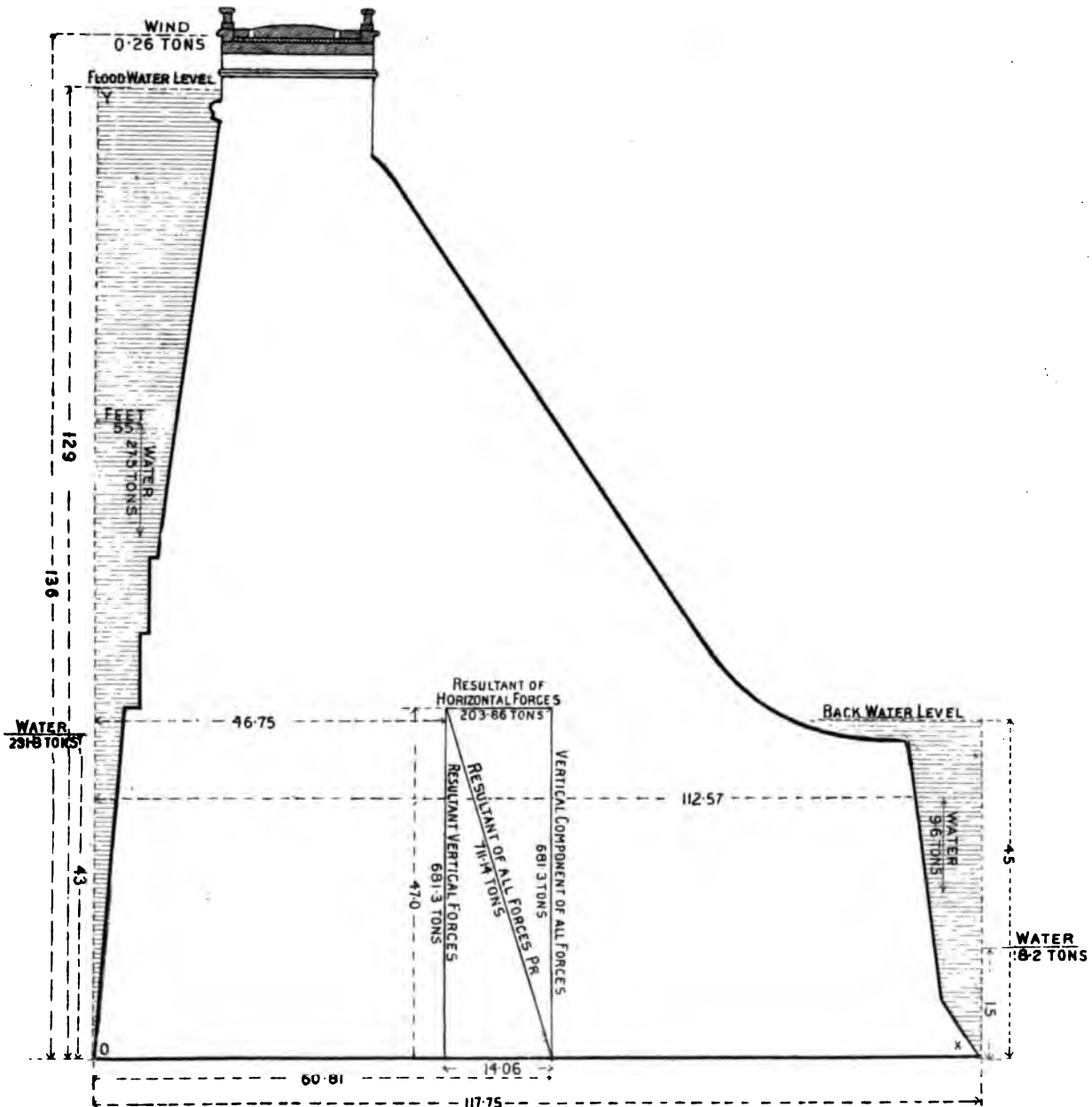
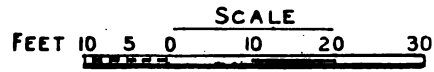








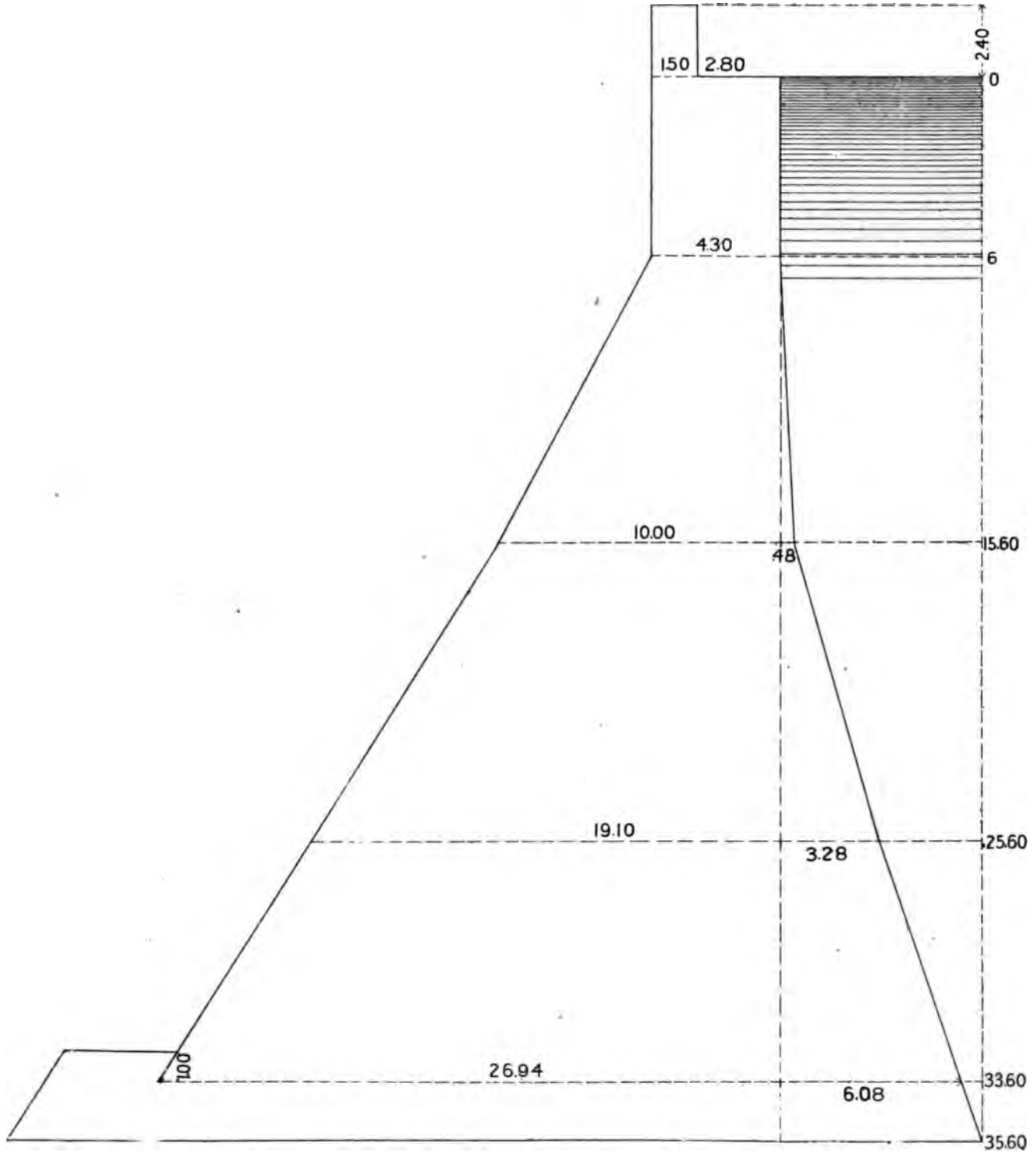
# VYRNWY DAM





# HABRA DAM

SCALE OF METRES.

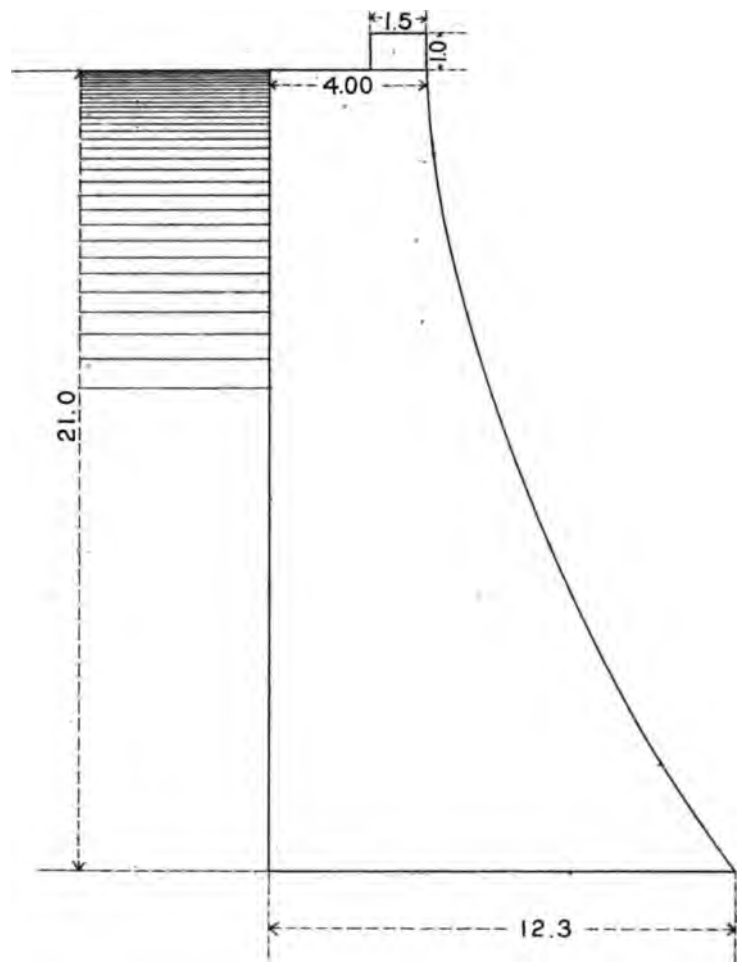
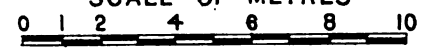






# TLELAT DAM

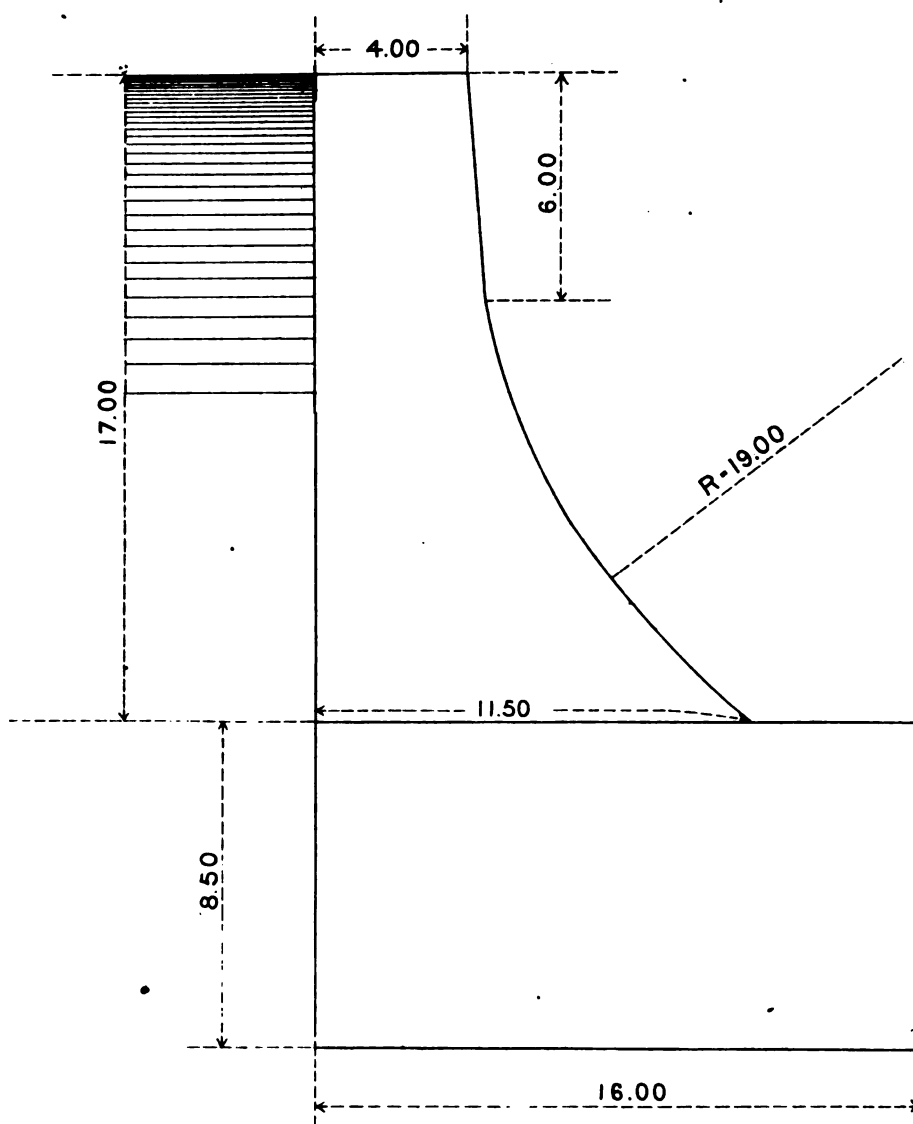
SCALE OF METRES





# DJIDIONIA DAM

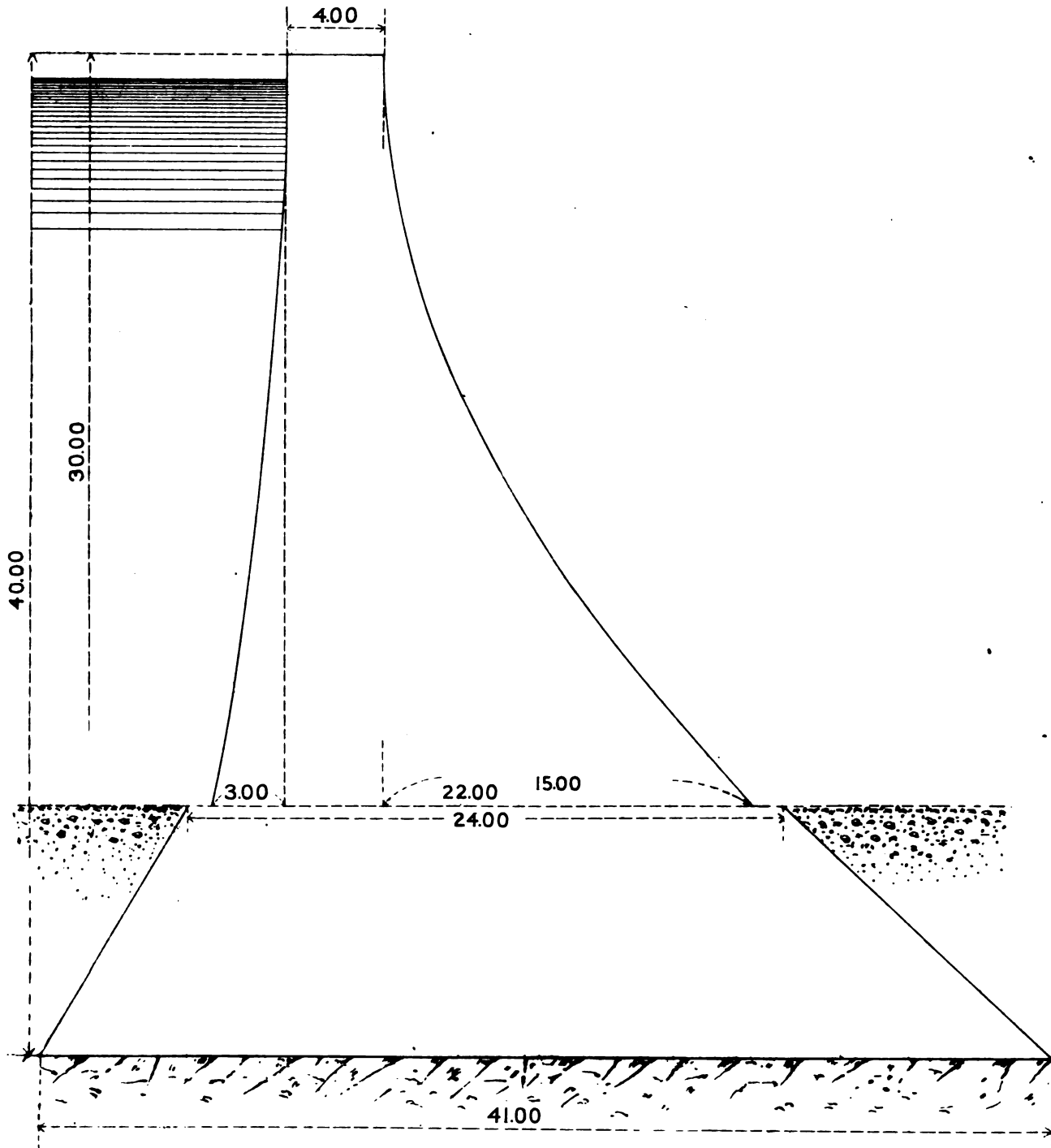
SCALE OF METRES  
0 1 2 3 4 5 6 7 8 9 10



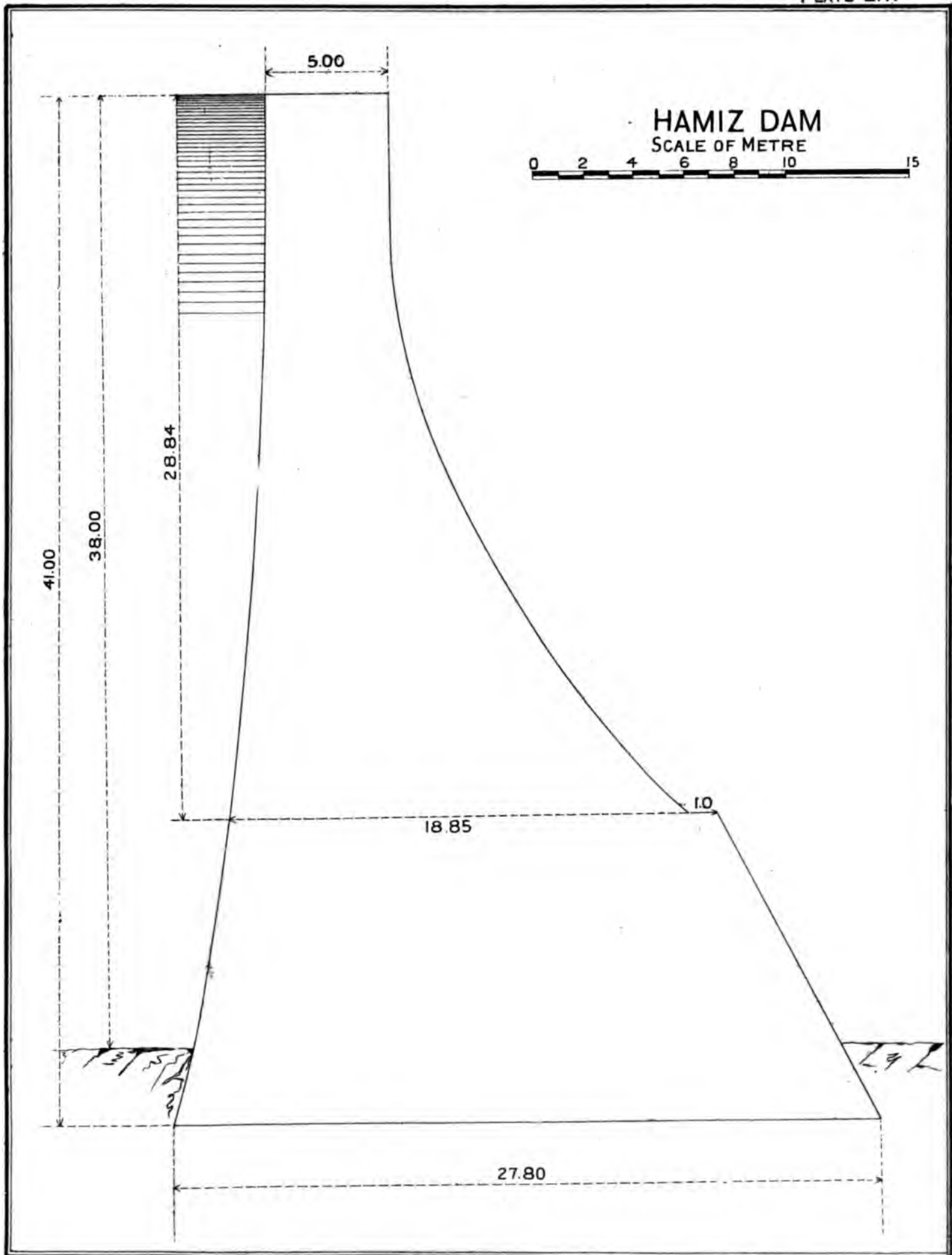


# GRAN CHEURFAS DAM

SCALE OF METRES.  
0 2 4 6 8 10













1

2

3

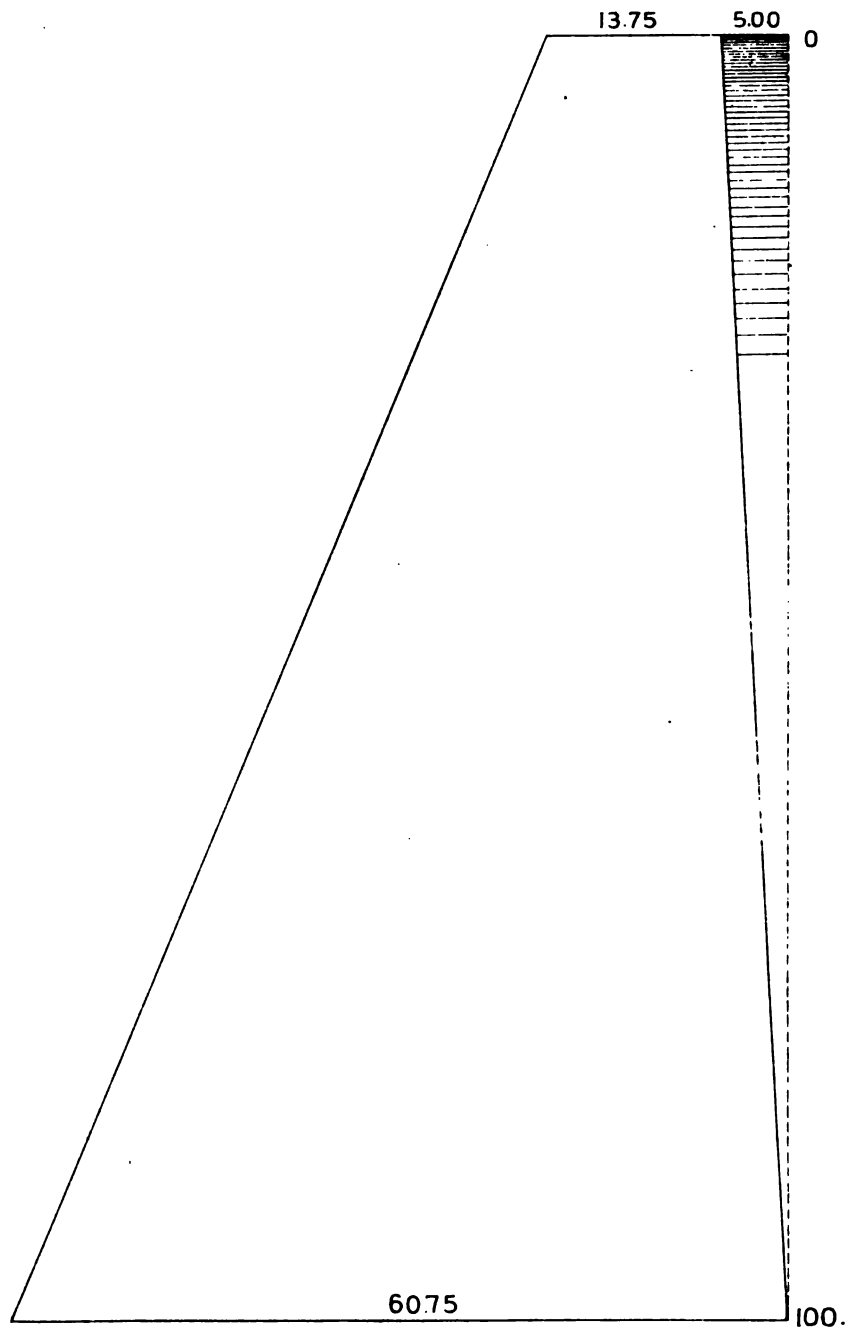
4

5

6

7

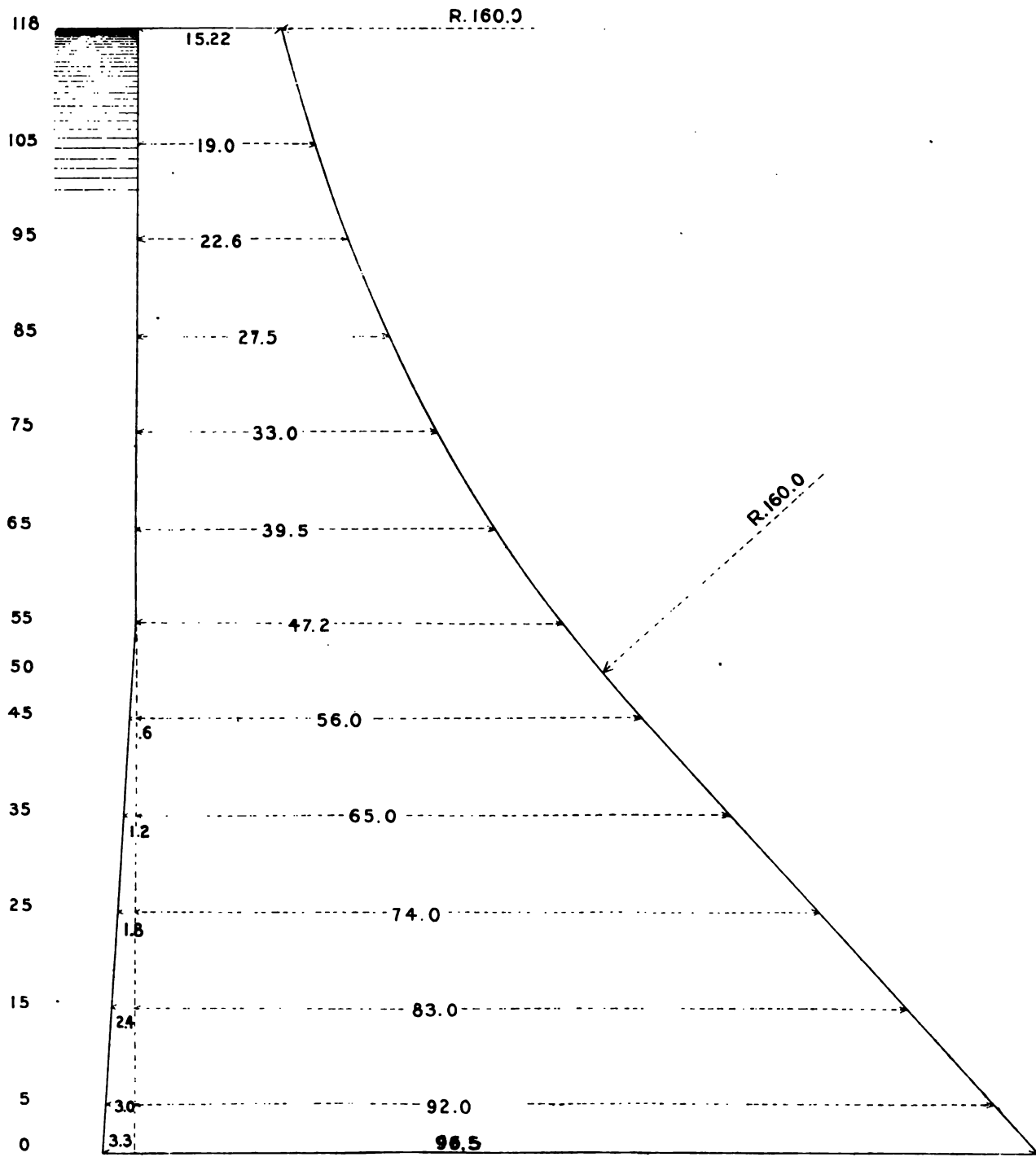
**POONA DAM**  
SCALE OF FEET  
0 12 4 8 12 16 20

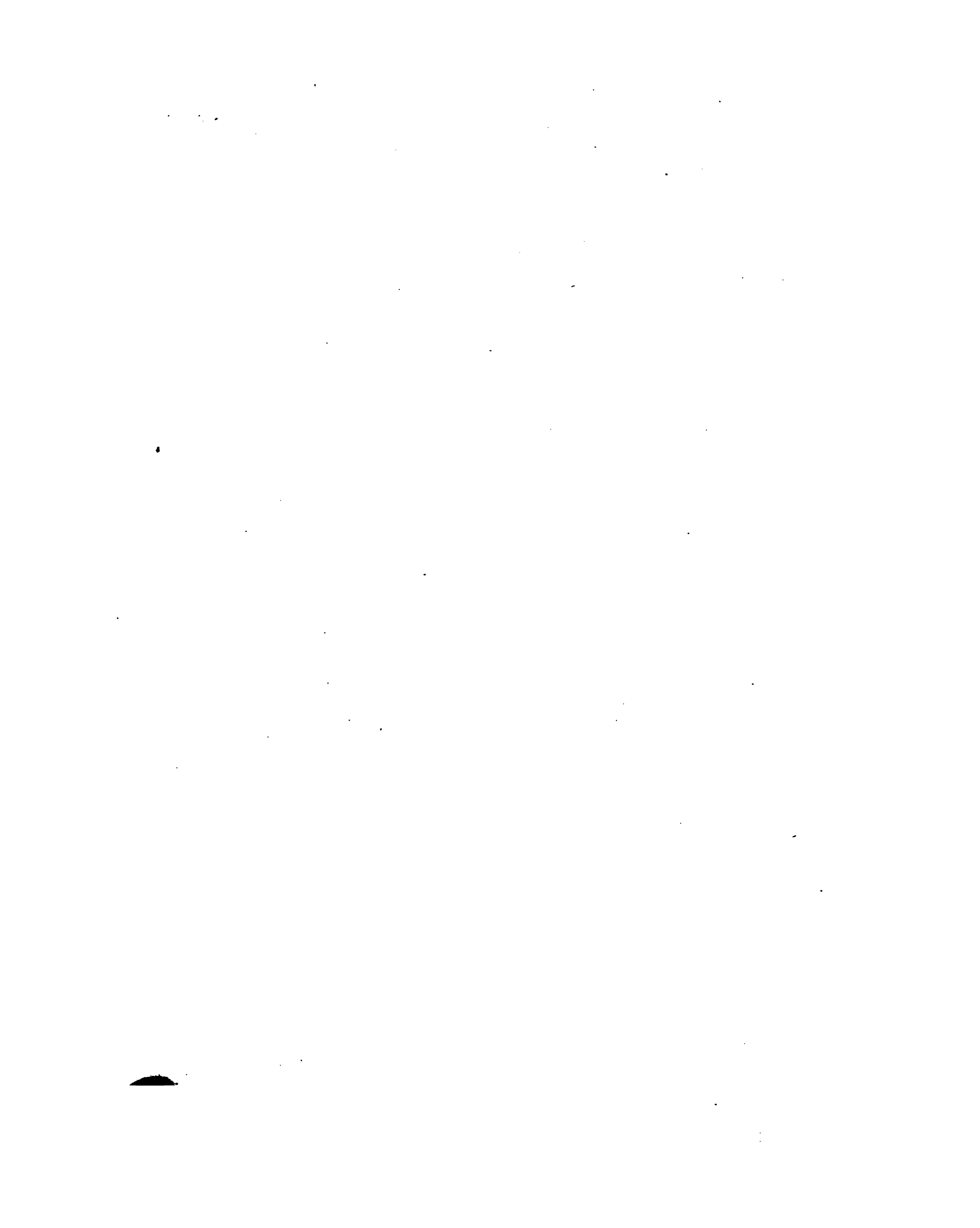




# TANSA DAM

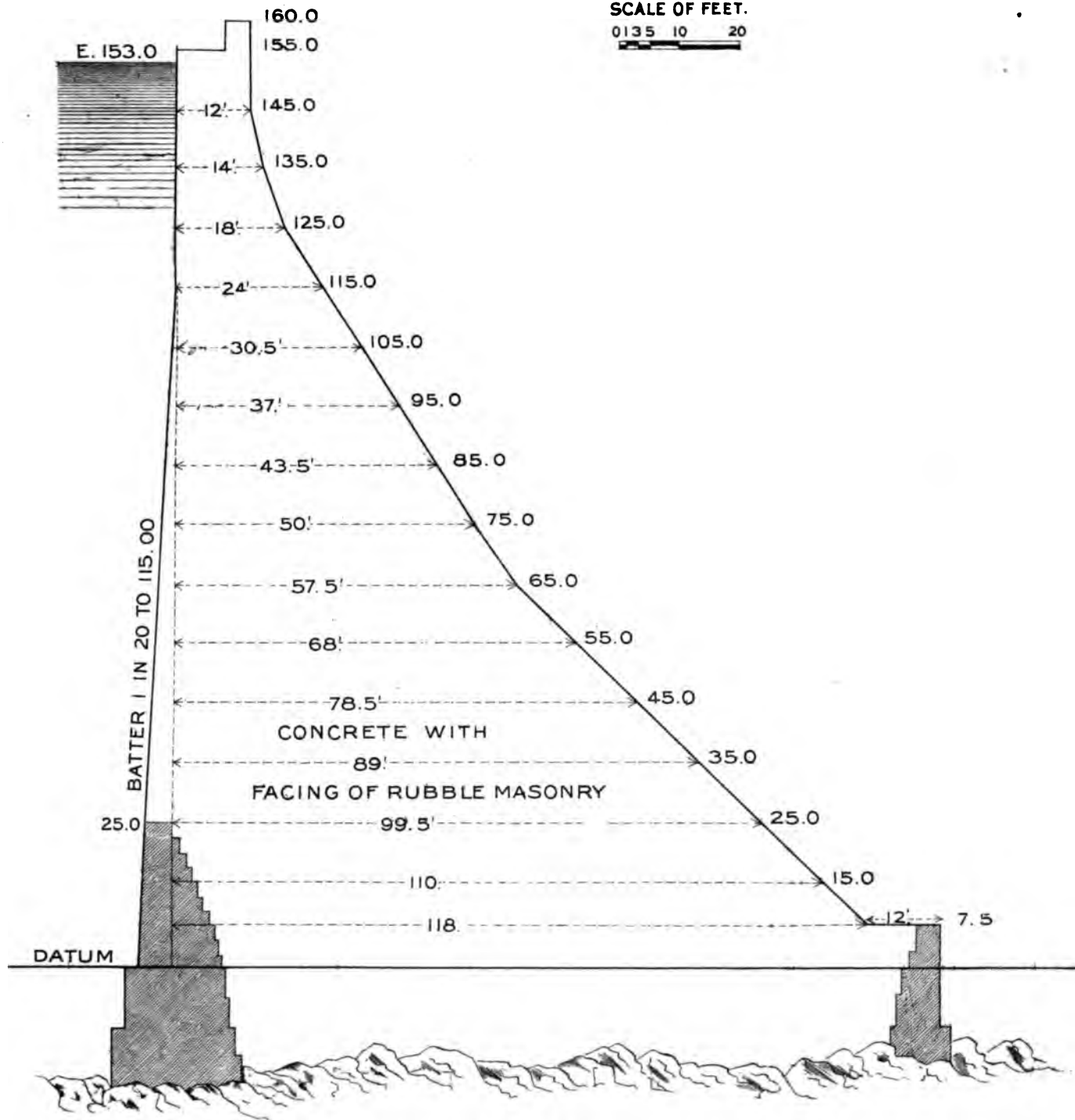
SCALE OF FEET.  
0 1 3 5 10 20





# PERIAR DAM.

SCALE OF FEET.  
0 135 10 20

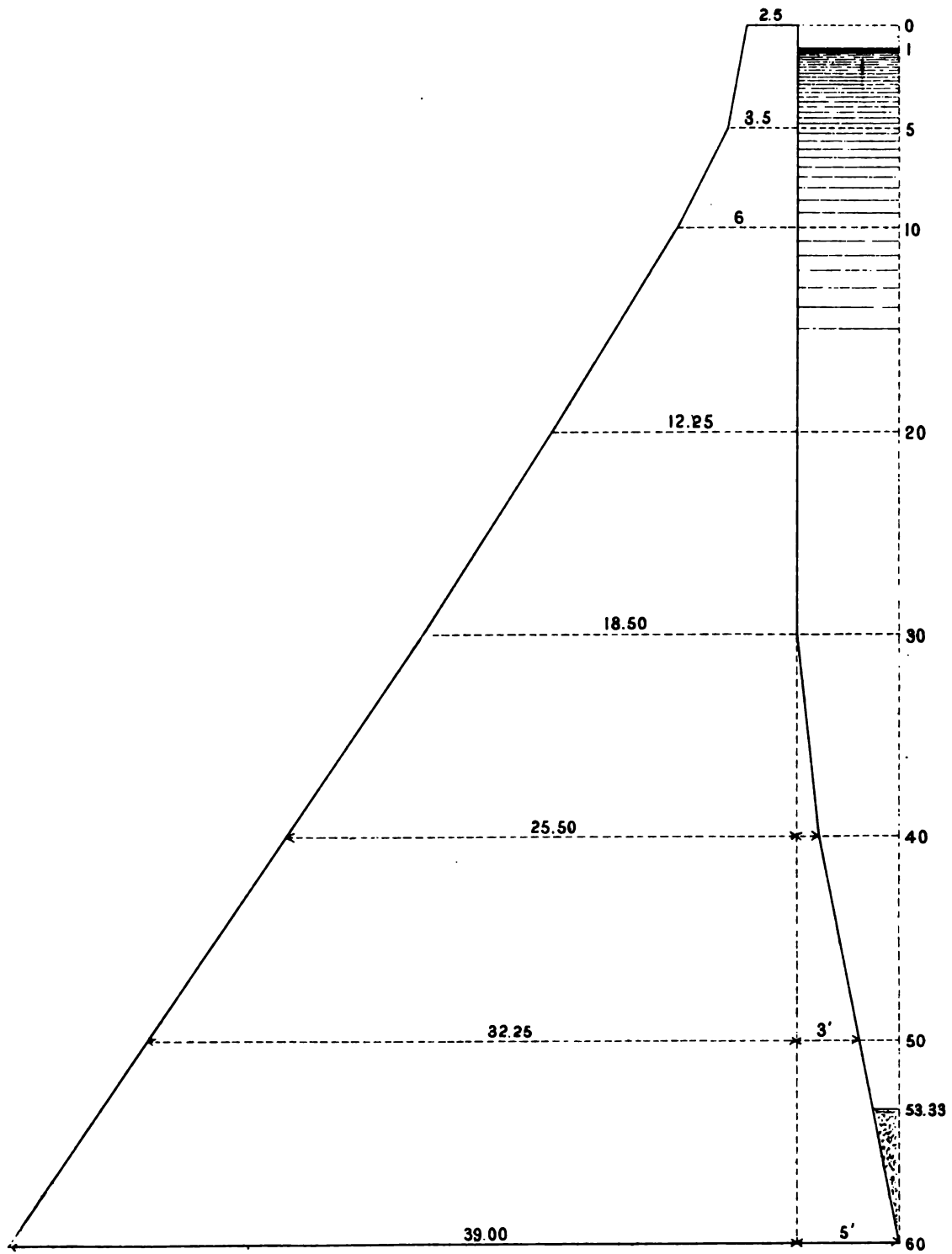


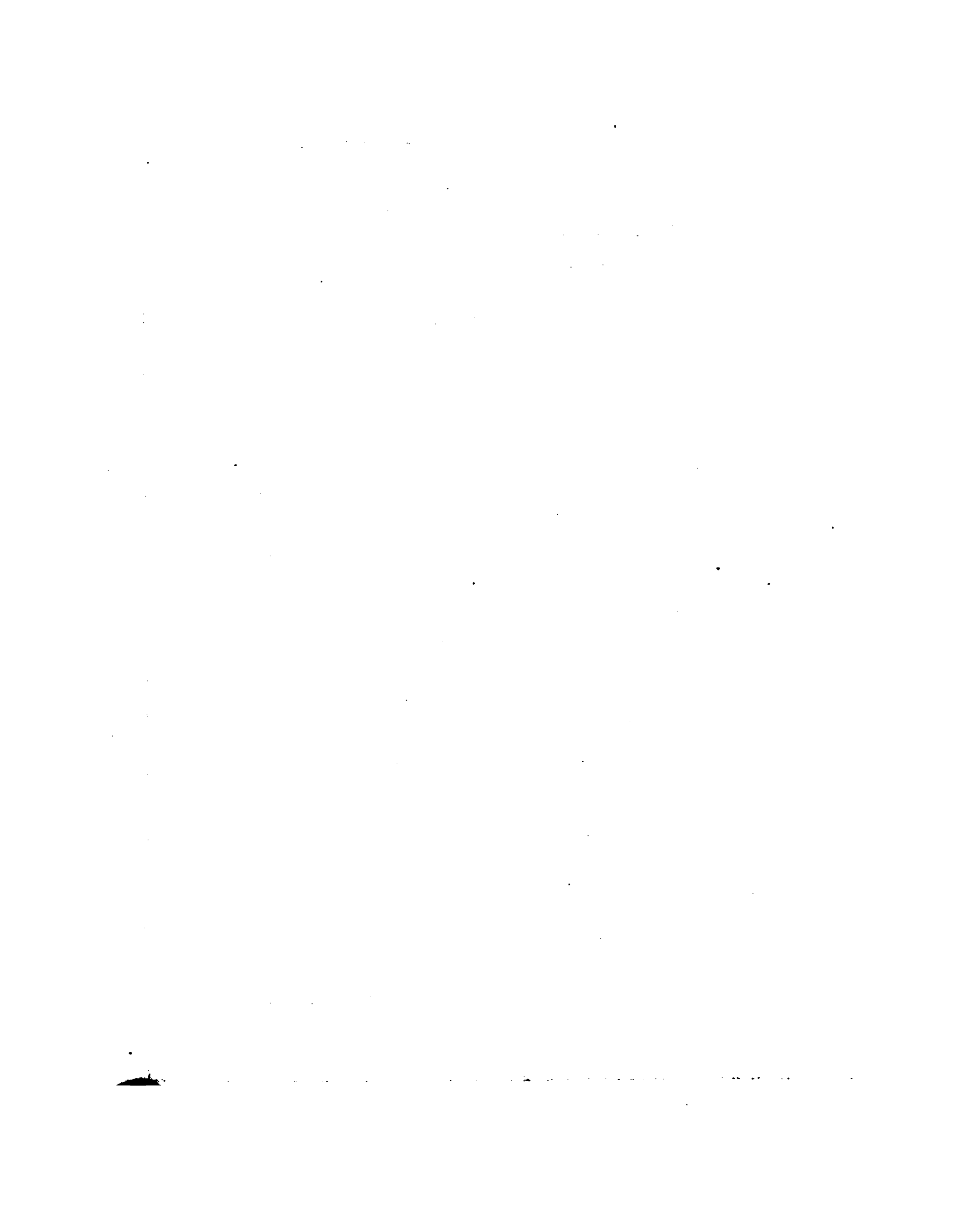




# GEELONG DAM

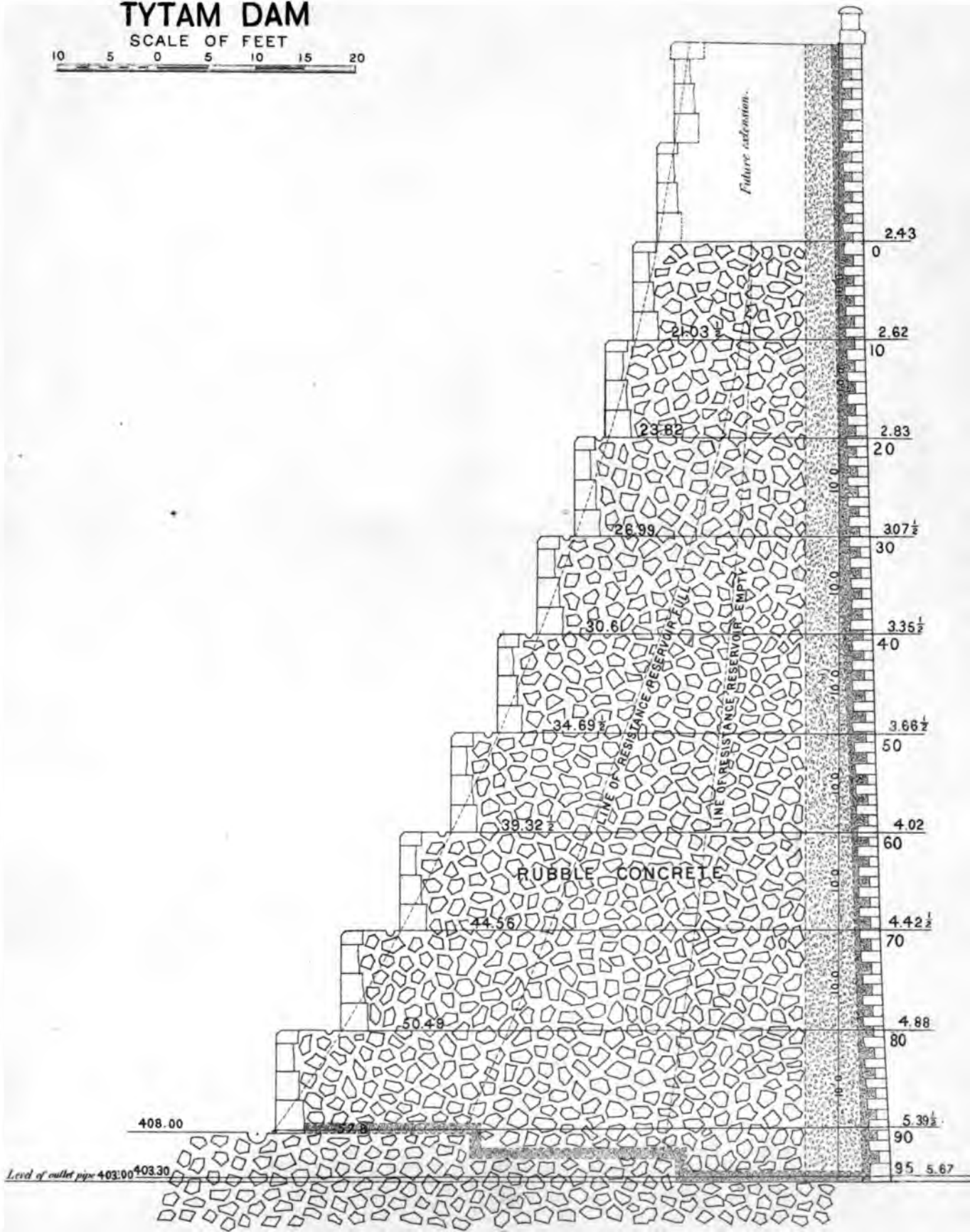
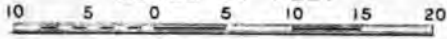
SCALE OF FEET  
0 1 2 4 6 8 10





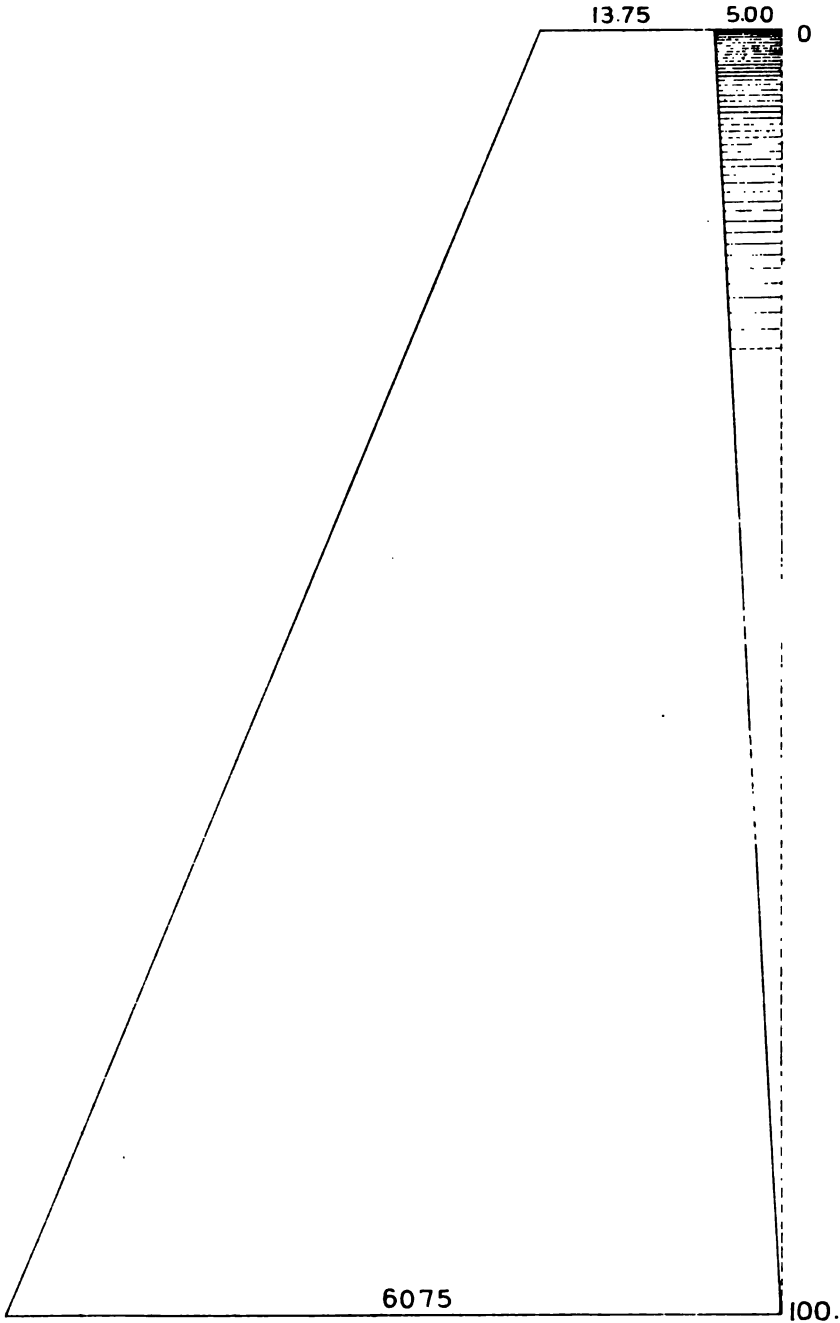
# TYTAM DAM

SCALE OF FEET





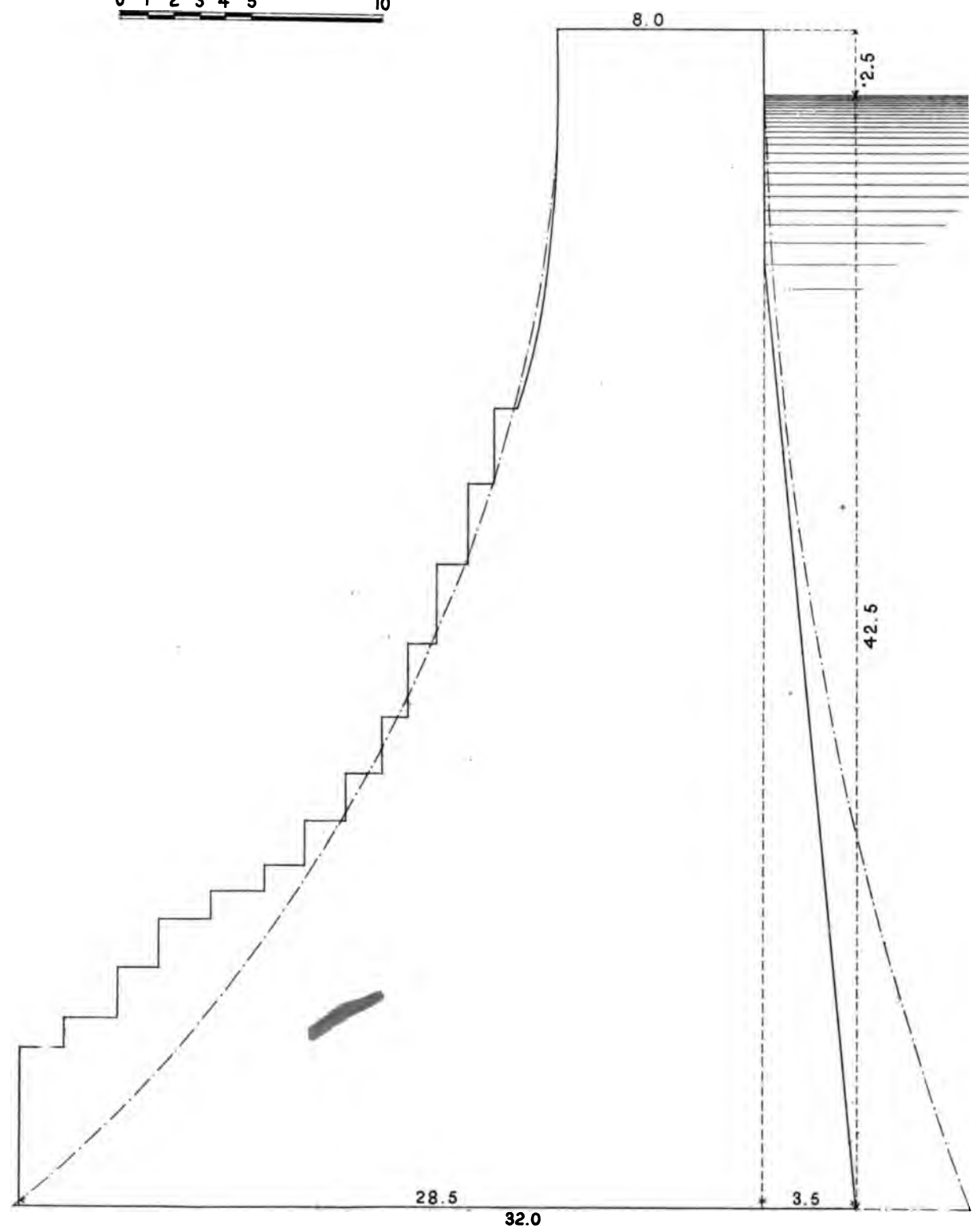
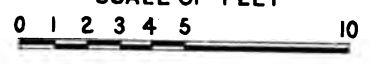
**POONA DAM**  
SCALE OF FEET  
0 2 4 8 12 16 20





# BRIDGEPORT DAM

SCALE OF FEET

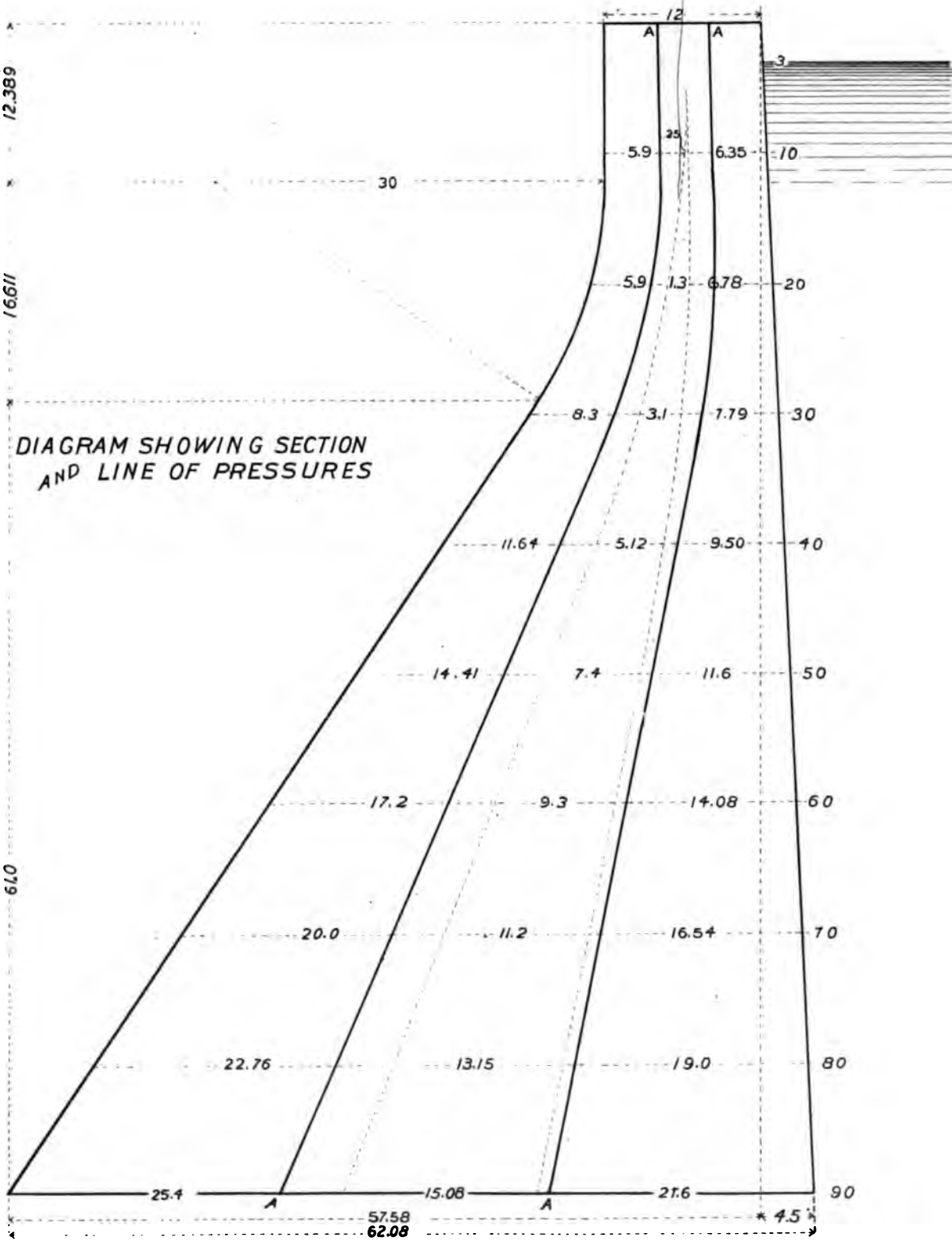




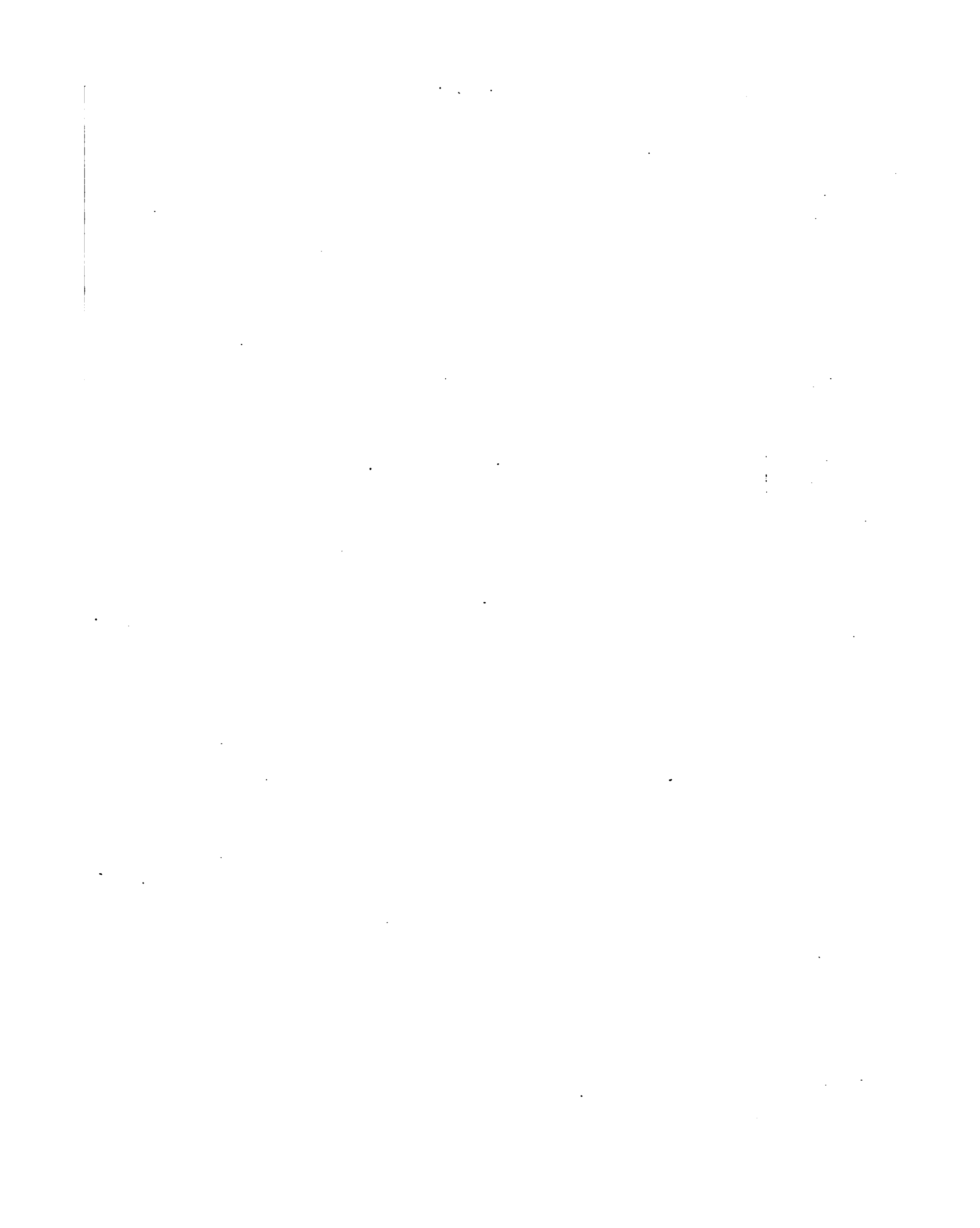


# WIGWAM DAM

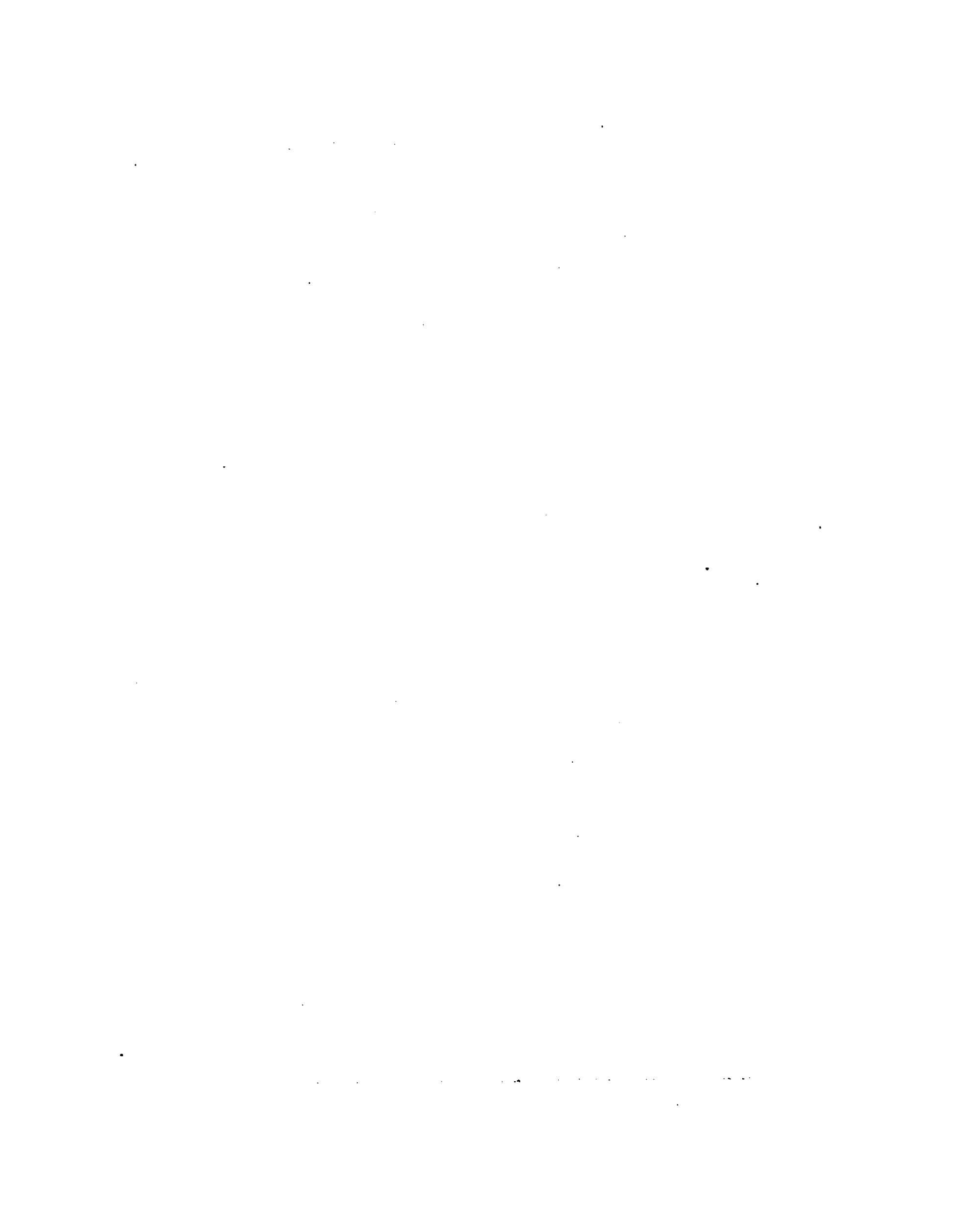
SCALE IN FEET



A—A. LINES DEFINING THE MIDDLE THIRD  
 WATER TAKEN AT 62.5 LBS. PER CU.FT.  
 MASONRY . . . 150 . . . . .

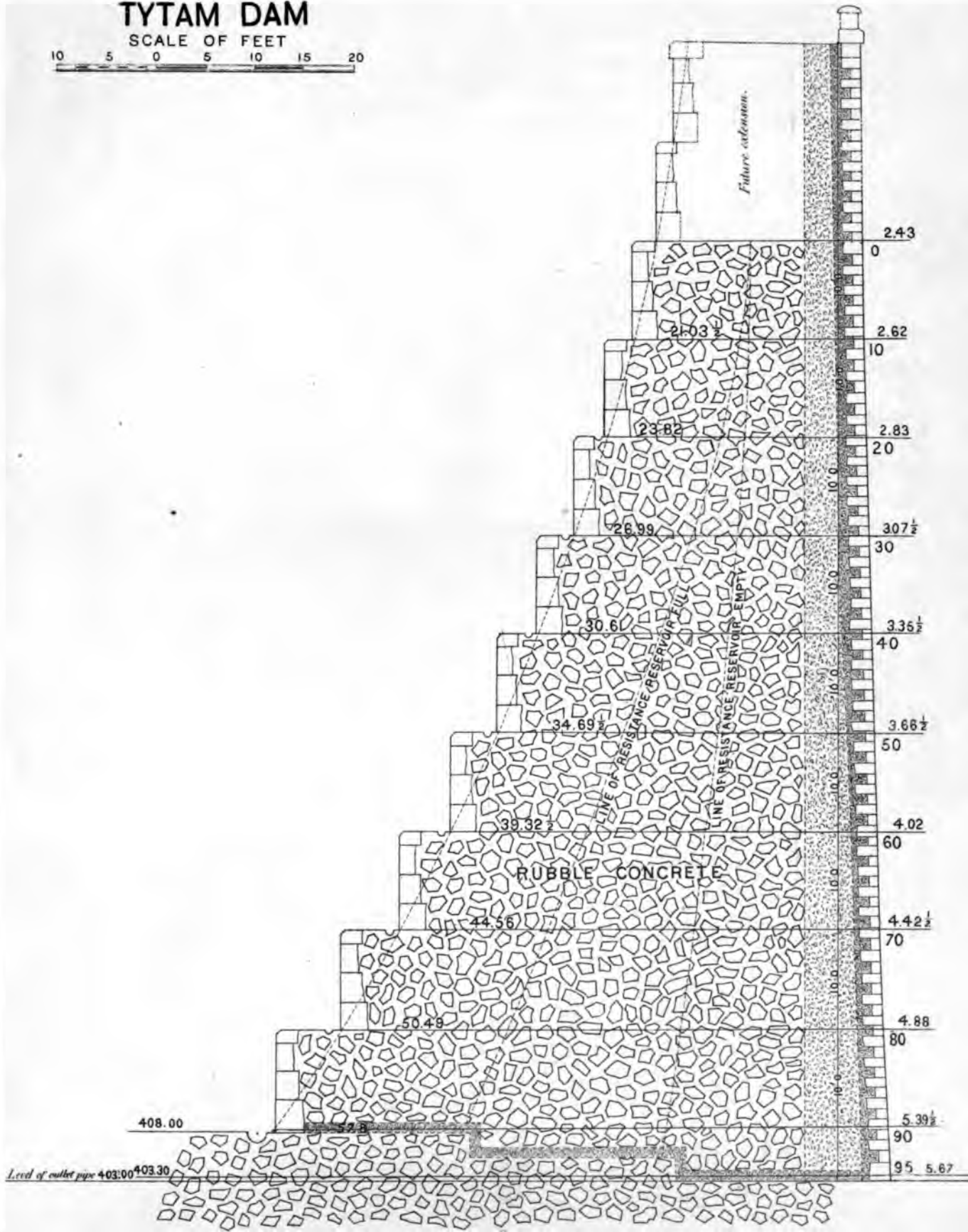
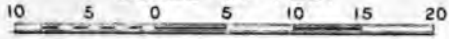






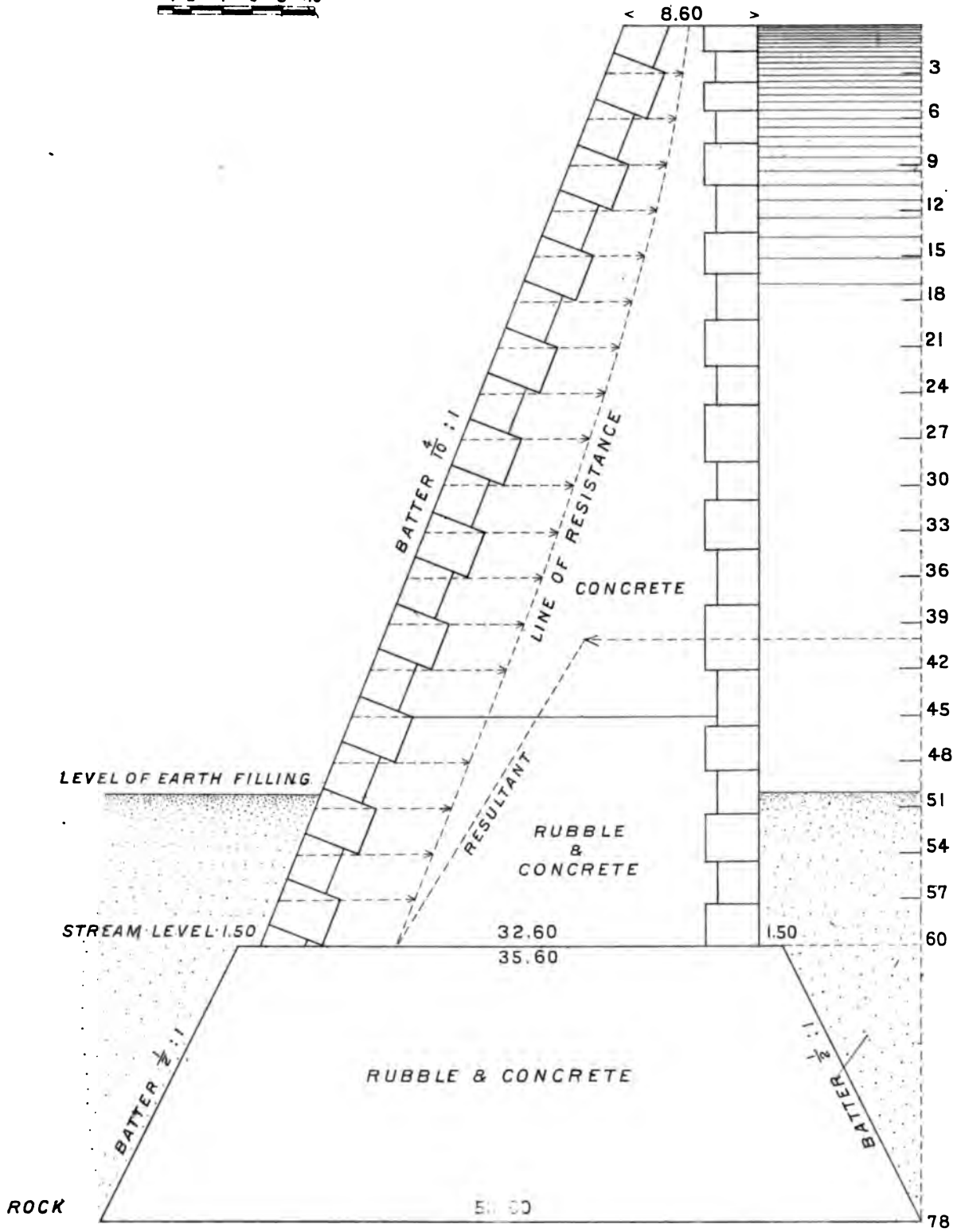
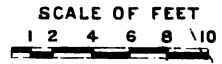
# TYTAM DAM

SCALE OF FEET





# BOYD'S CORNERS DAM

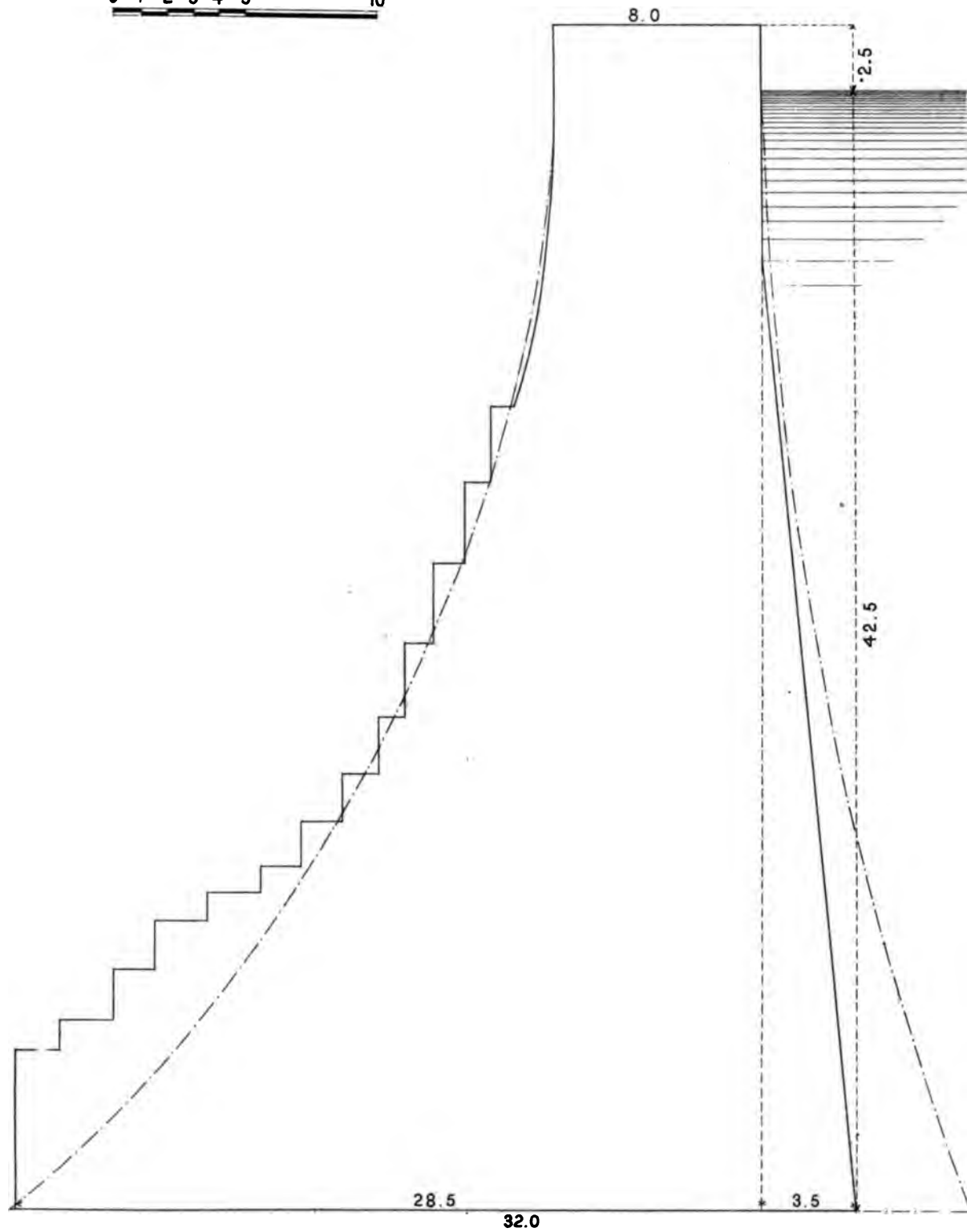
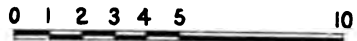






# BRIDGEPORT DAM

SCALE OF FEET





# WIGWAM DAM

SCALE IN FEET

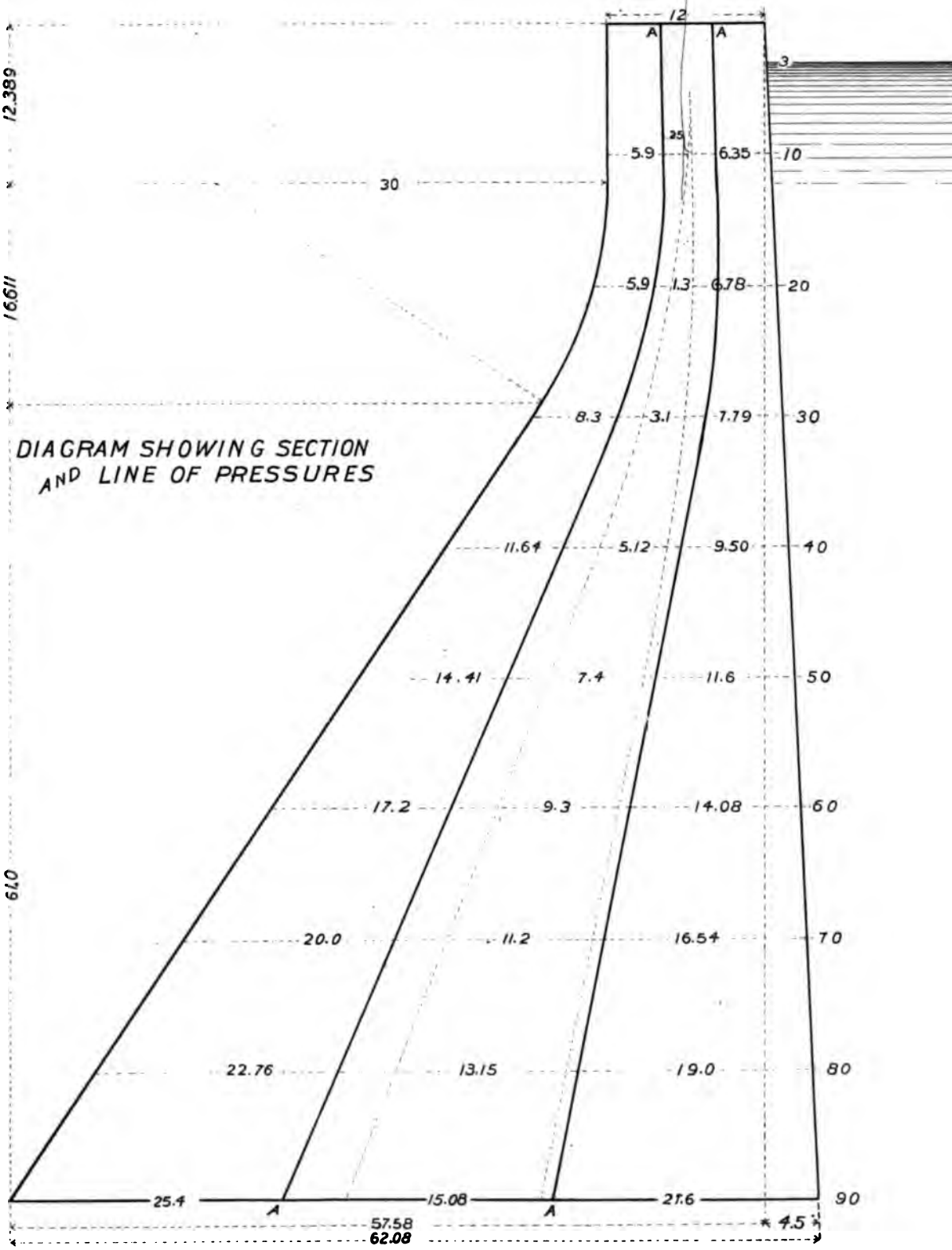
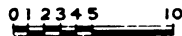


DIAGRAM SHOWING SECTION AND LINE OF PRESSURES

A—A. LINES DEFINING THE MIDDLE THIRD  
WATER TAKEN AT 62.5 LBS. PER CU. FT.  
MASONRY . . . 150 . . . . .

1

2

3

4

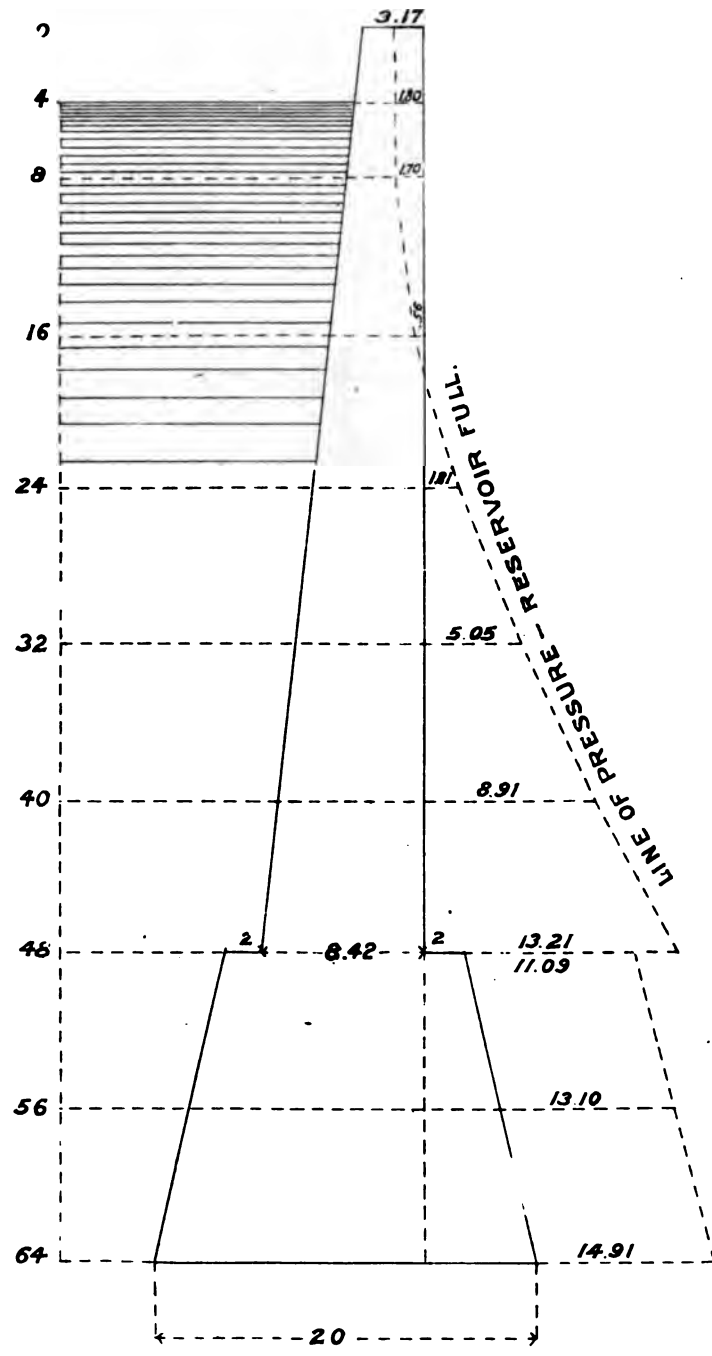
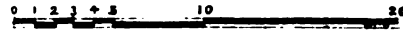
5





# BEAR VALLEY DAM

SCALE OF FEET.

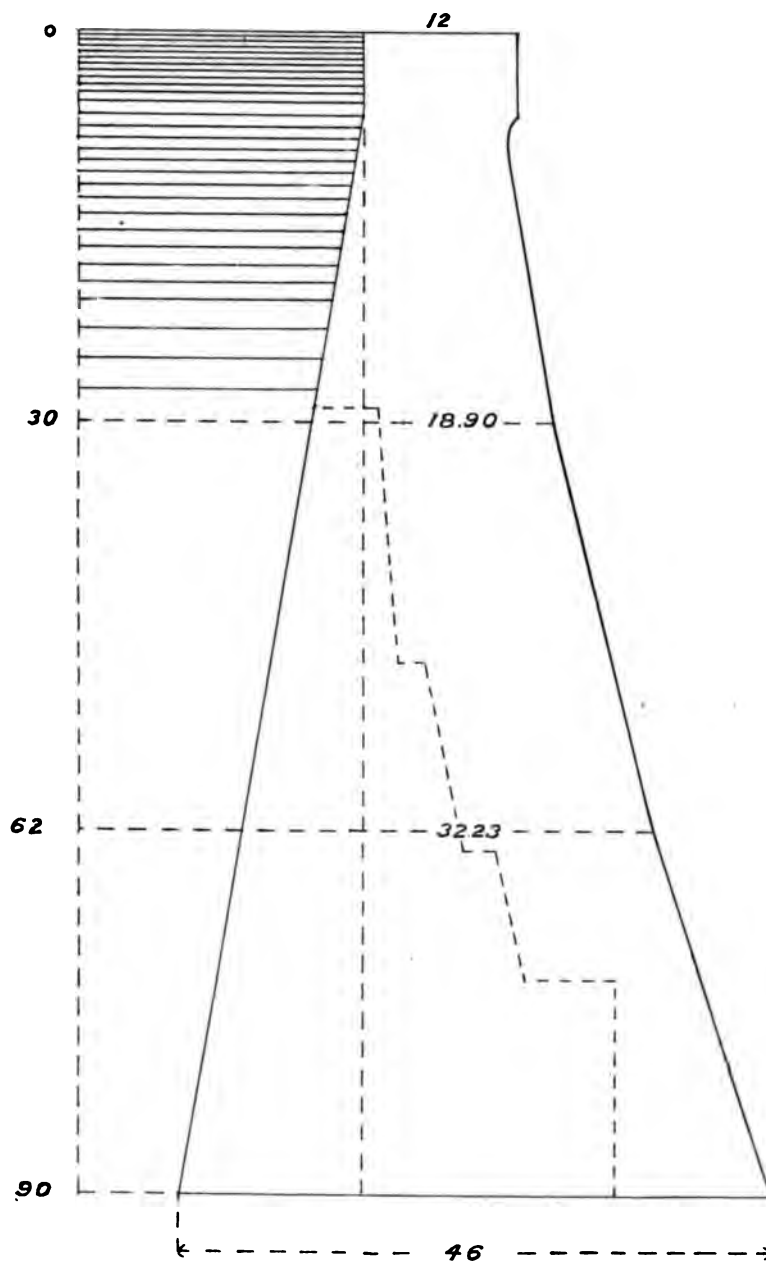






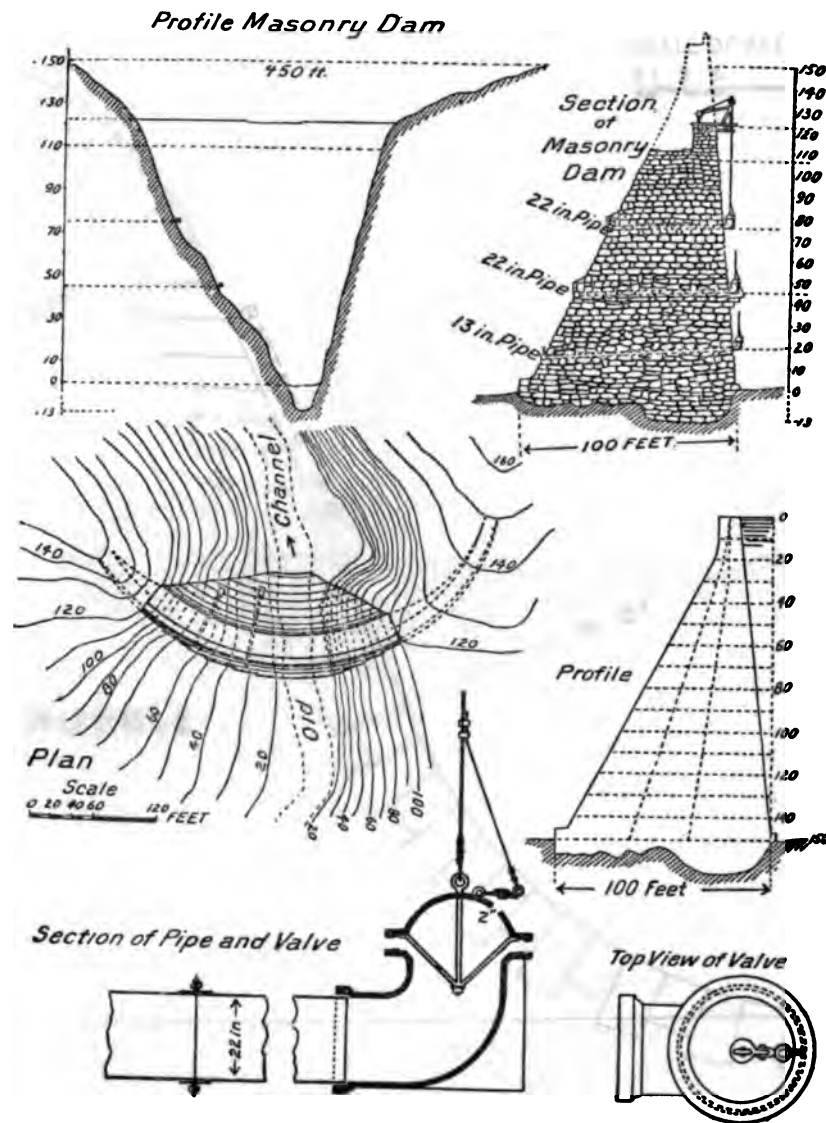
# SWEET WATER DAM

SCALE OF FEET.  
0 10 20





# HEMMET DAM.



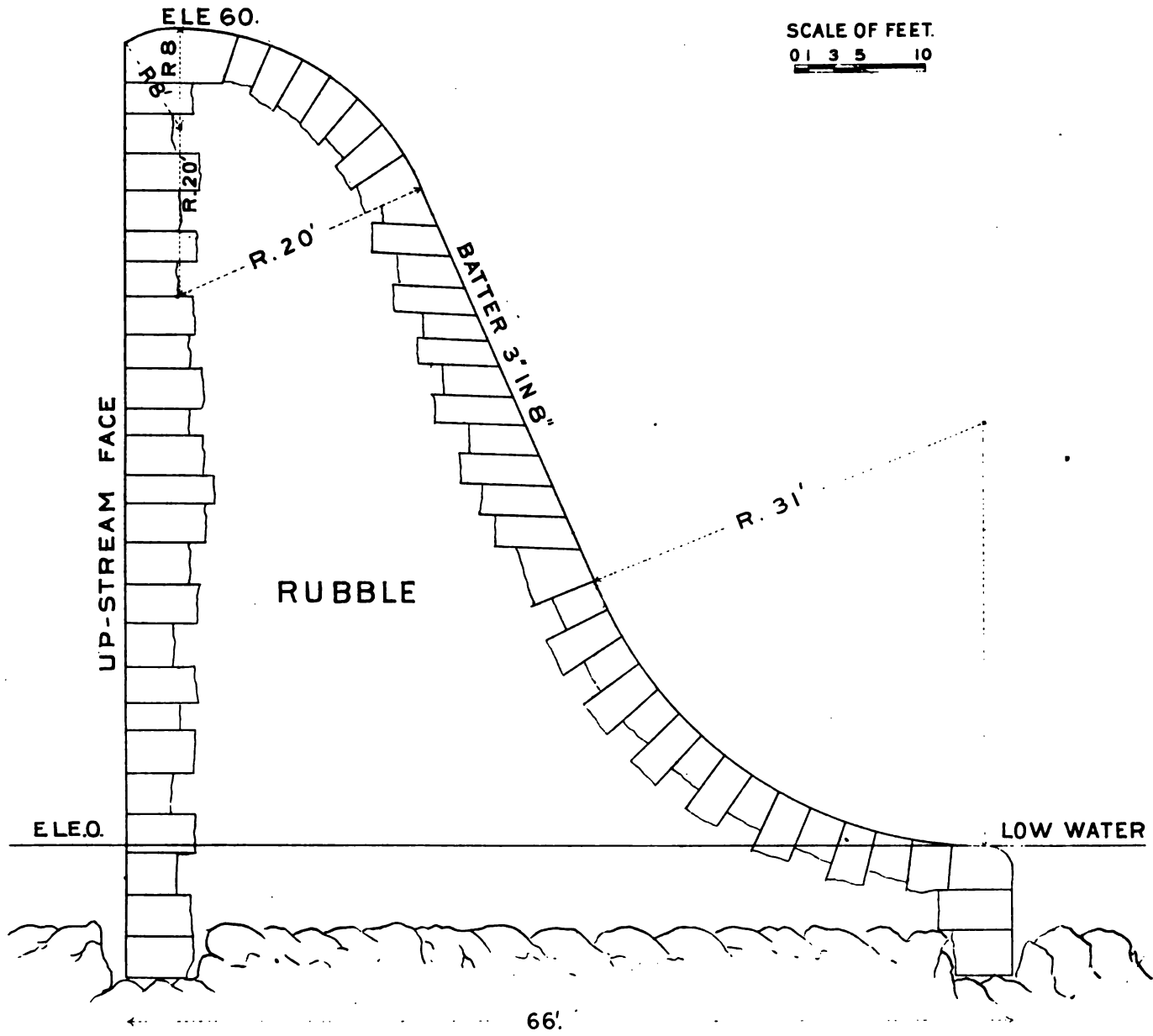
.....

.....

.....

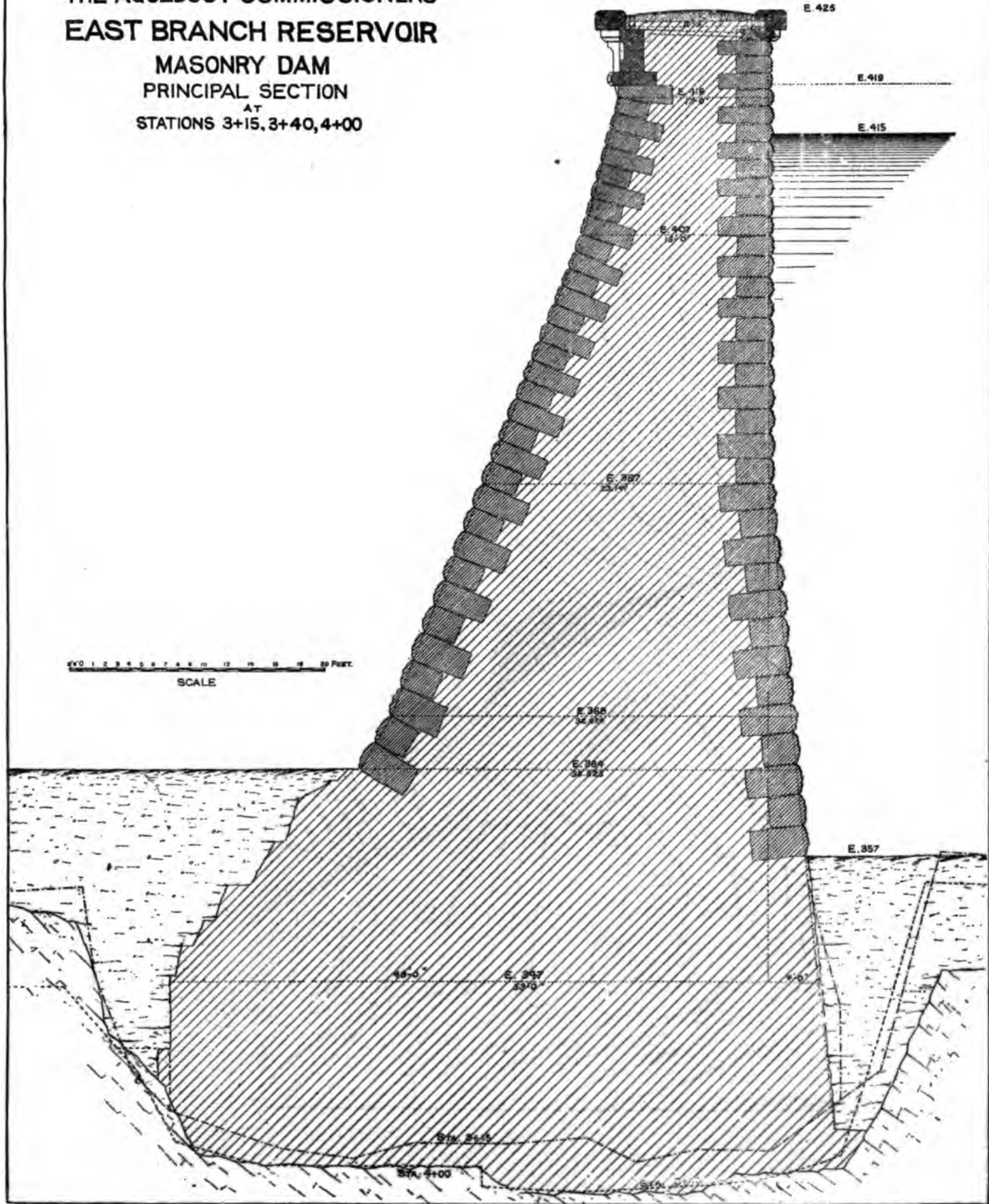
# COLORADO RIVER DAM.

SCALE OF FEET.  
0 1 3 5 10





THE AQUEDUCT COMMISSIONERS  
EAST BRANCH RESERVOIR  
MASONRY DAM  
PRINCIPAL SECTION  
AT  
STATIONS 3+15, 3+40, 4+00



.....

.....

•

.....

.....

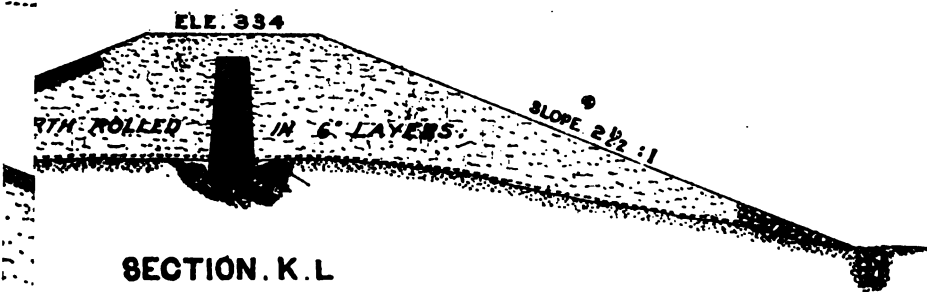
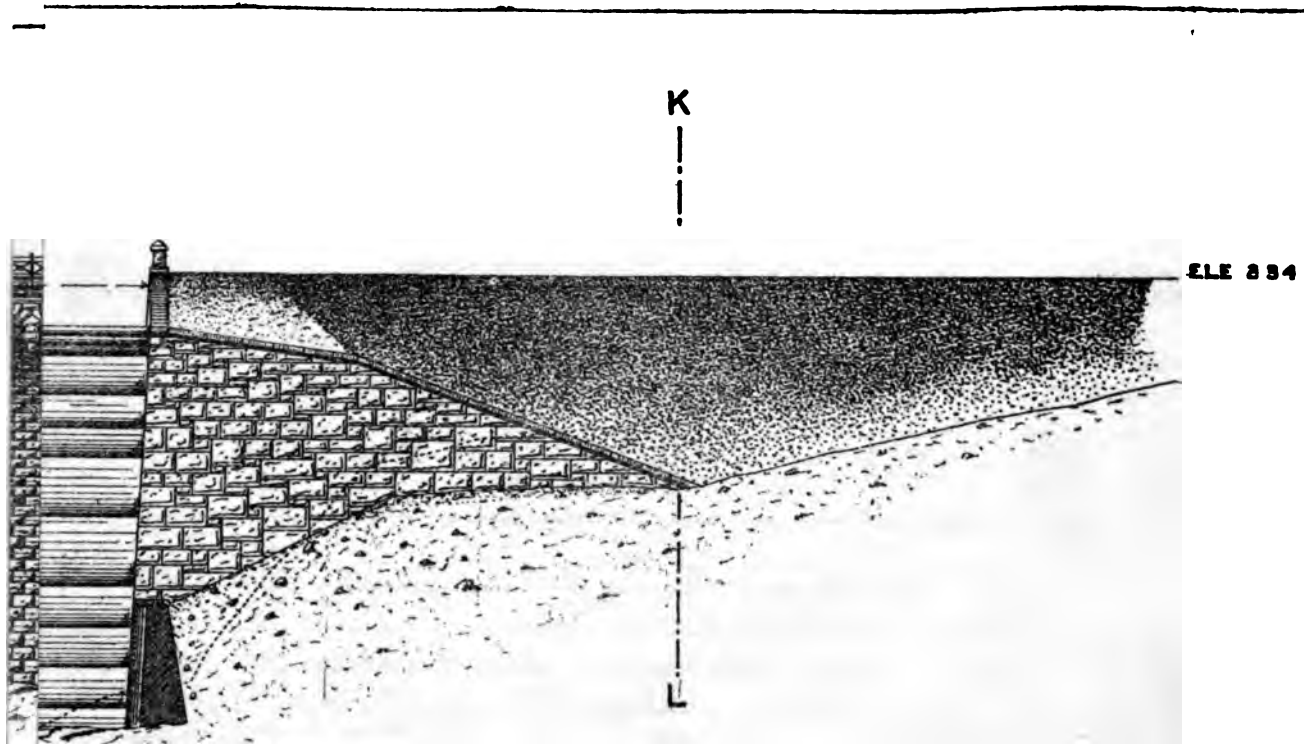
.....

.....







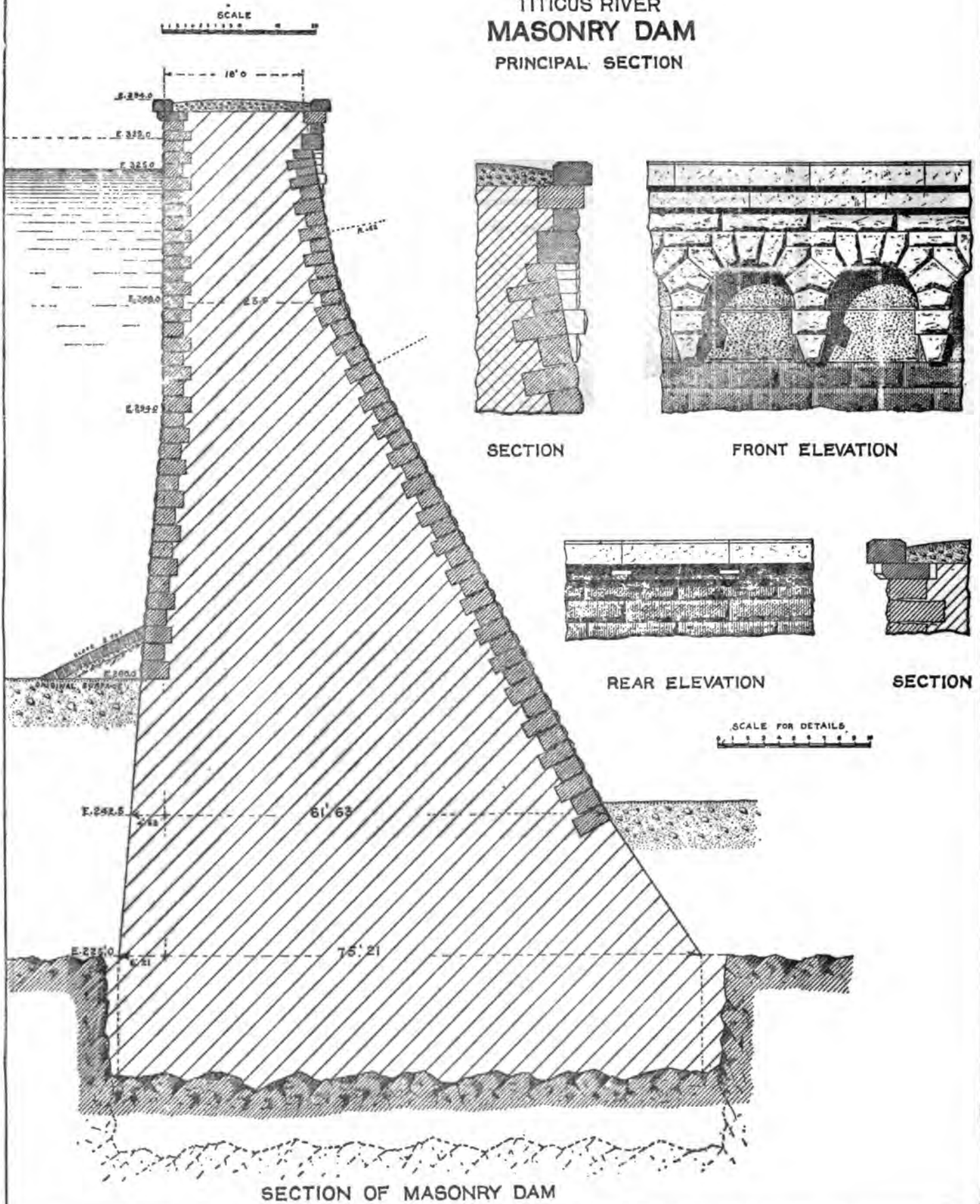


SECTION. K. L

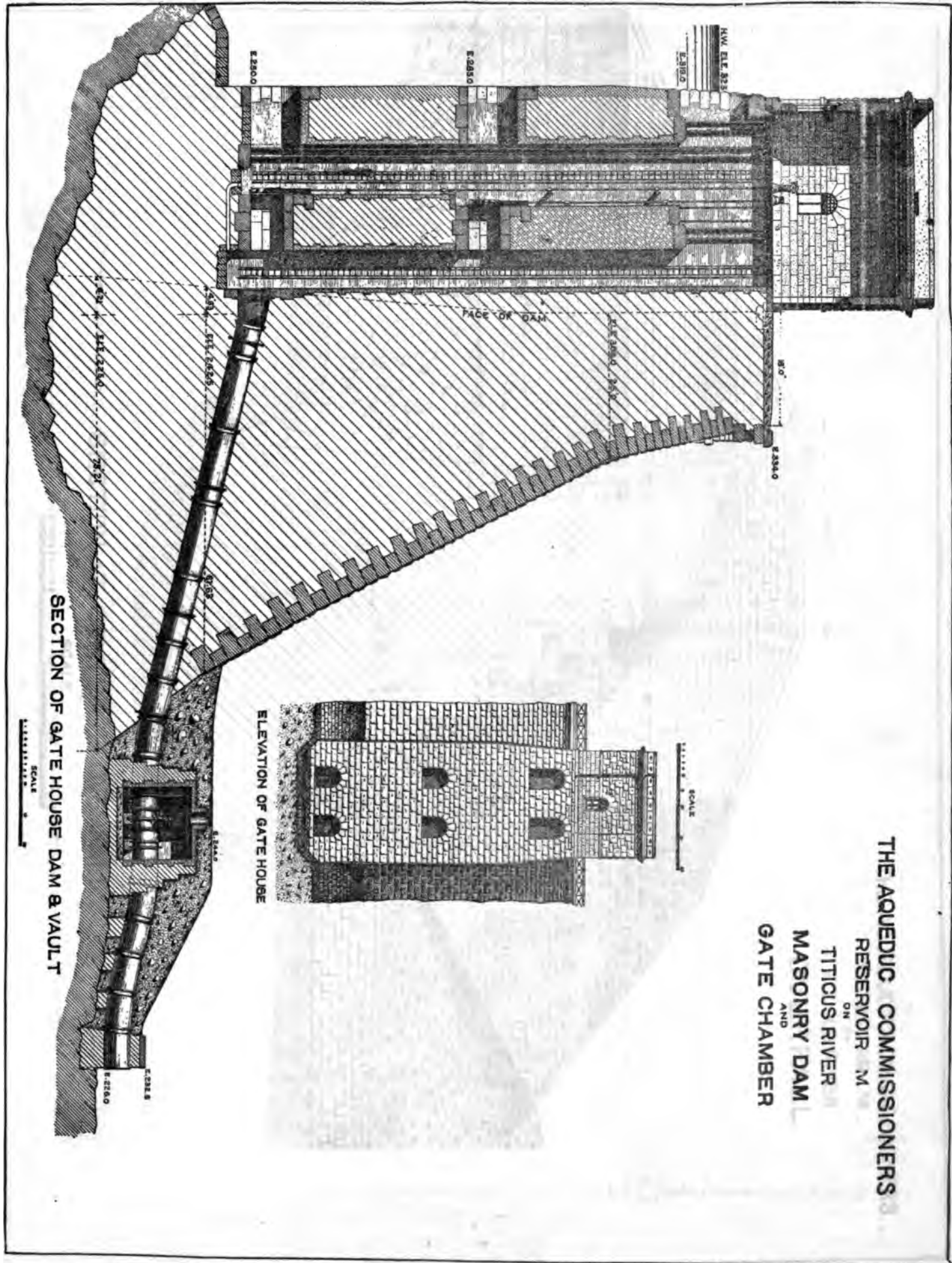
THE AQUEDUCT COMMISSIONERS  
ELEVATION AND SECTIONS  
OF  
MASONRY DAM  
RESERVOIR "M"  
TITICUS RIVER  
PURDYS STATION  
WESTCHESTER COUNTY N.Y.

Vertical line of text on the left side of the page, possibly a page number or margin indicator.

THE AQUEDUCT COMMISSIONERS  
RESERVOIR M  
ON  
TITICUS RIVER  
**MASONRY DAM**  
PRINCIPAL SECTION

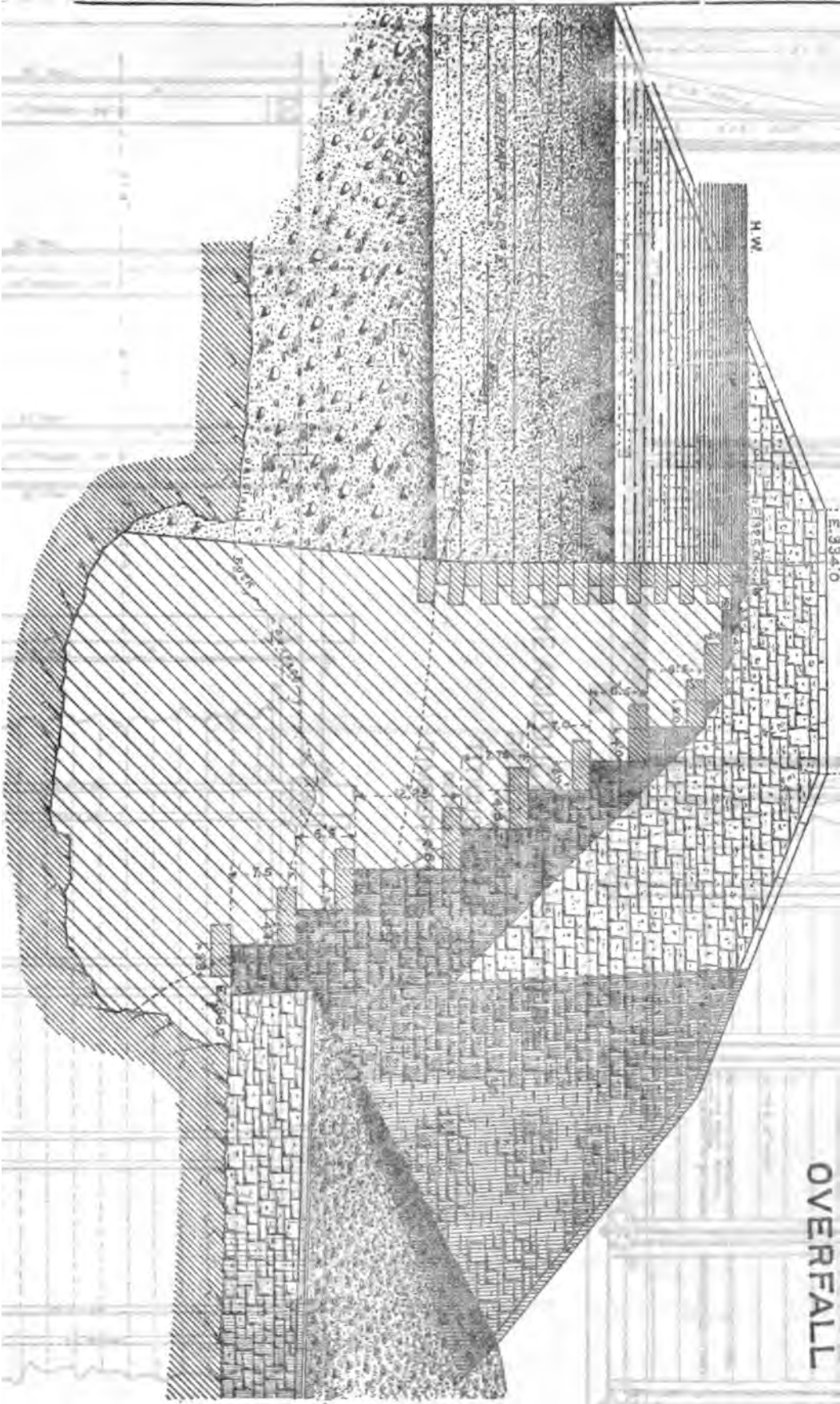












THE AQUEDUCT COMMISSIONERS  
RESERVOIR M<sup>N</sup>  
TITICUS RIVER  
OVERFALL

SECTION AT CENTER OF OVERFALL







1. The first part of the document discusses the importance of maintaining accurate records of all transactions and activities. It emphasizes that proper record-keeping is essential for transparency and accountability, particularly in the context of public administration and government operations. This section also highlights the role of technology in streamlining record management processes and reducing the risk of data loss or corruption.

2. The second part of the document focuses on the implementation of robust internal controls and risk management frameworks. It outlines the need for regular audits and assessments to identify potential vulnerabilities and ensure compliance with relevant laws and regulations. This section also discusses the importance of fostering a culture of integrity and ethical behavior among all employees and stakeholders.

3. The third part of the document addresses the challenges of data security and privacy protection in the digital age. It emphasizes the need for strong encryption, access controls, and regular security updates to safeguard sensitive information from unauthorized access and cyber threats. This section also discusses the importance of educating employees about data security best practices and the potential consequences of data breaches.

4. The fourth part of the document discusses the importance of effective communication and stakeholder engagement. It emphasizes the need for clear, concise, and timely communication to ensure that all parties involved in the process are well-informed and aligned with the organization's goals and objectives. This section also discusses the importance of listening to feedback and addressing concerns in a transparent and responsive manner.

5. The fifth part of the document discusses the importance of continuous improvement and innovation. It emphasizes the need for regular evaluation and refinement of processes and procedures to ensure that the organization remains competitive and responsive to changing market conditions and stakeholder expectations. This section also discusses the importance of investing in research and development to drive innovation and create new value for the organization.

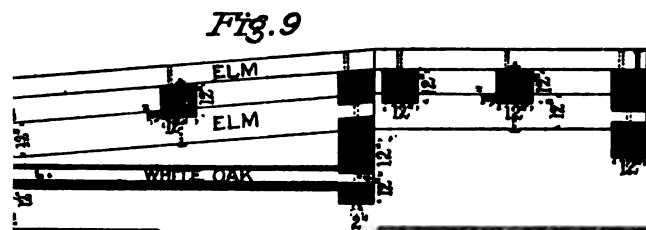
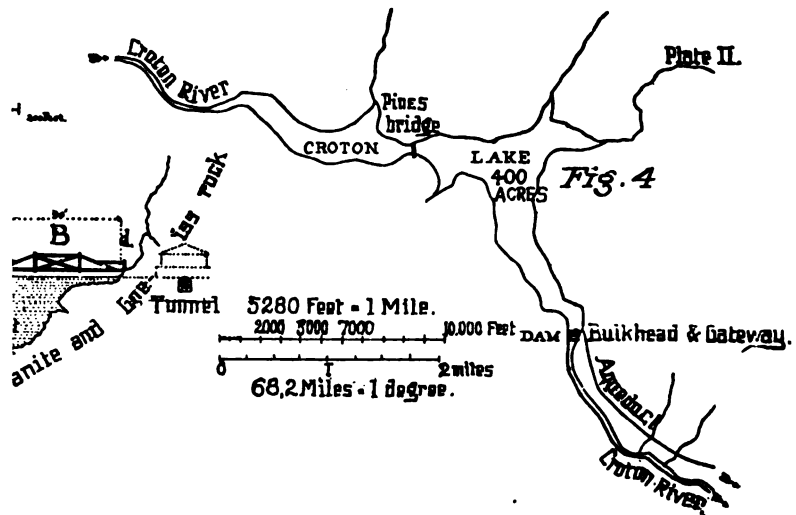
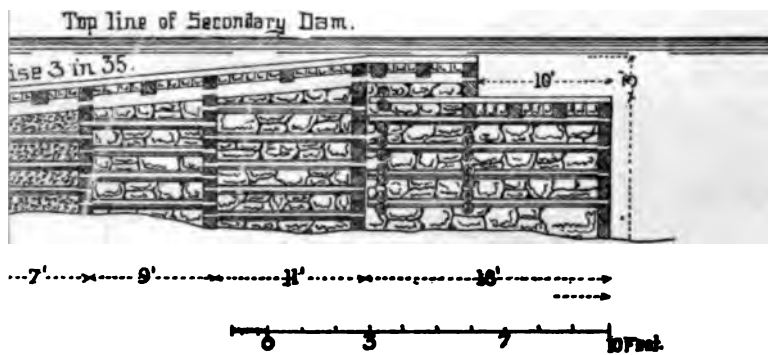
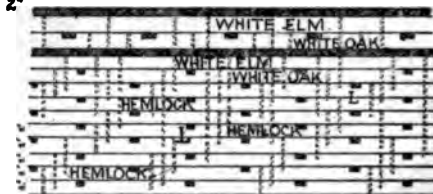


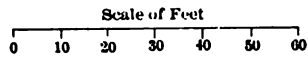
Fig. 7  
W. ELM.

Fig. 8  
W. OAK



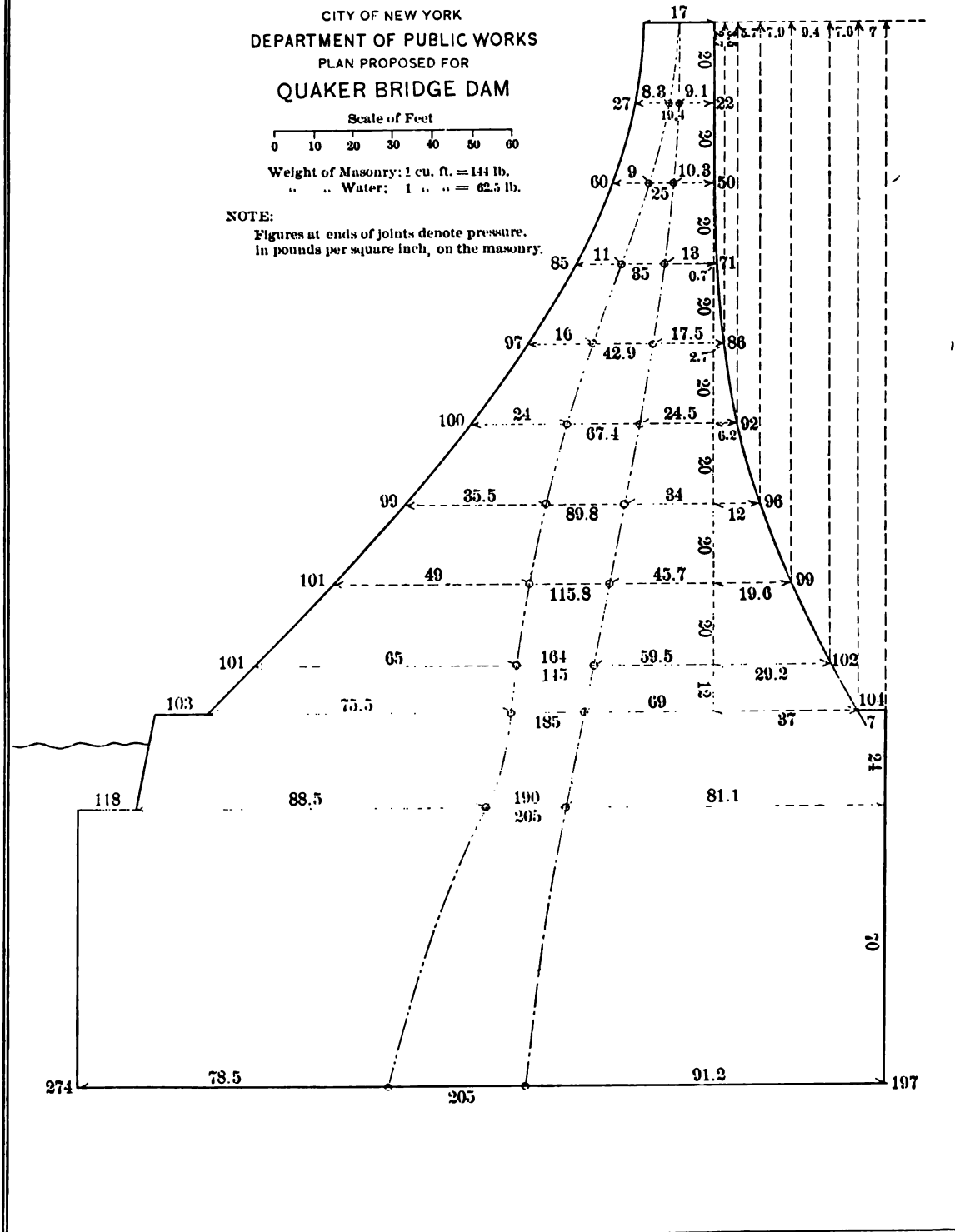


CITY OF NEW YORK  
 DEPARTMENT OF PUBLIC WORKS  
 PLAN PROPOSED FOR  
**QUAKER BRIDGE DAM**



Weight of Masonry: 1 cu. ft. = 144 lb.  
 " " Water: 1 " " = 62.5 lb.

**NOTE:**  
 Figures at ends of joints denote pressure.  
 In pounds per square inch, on the masonry.



1

2

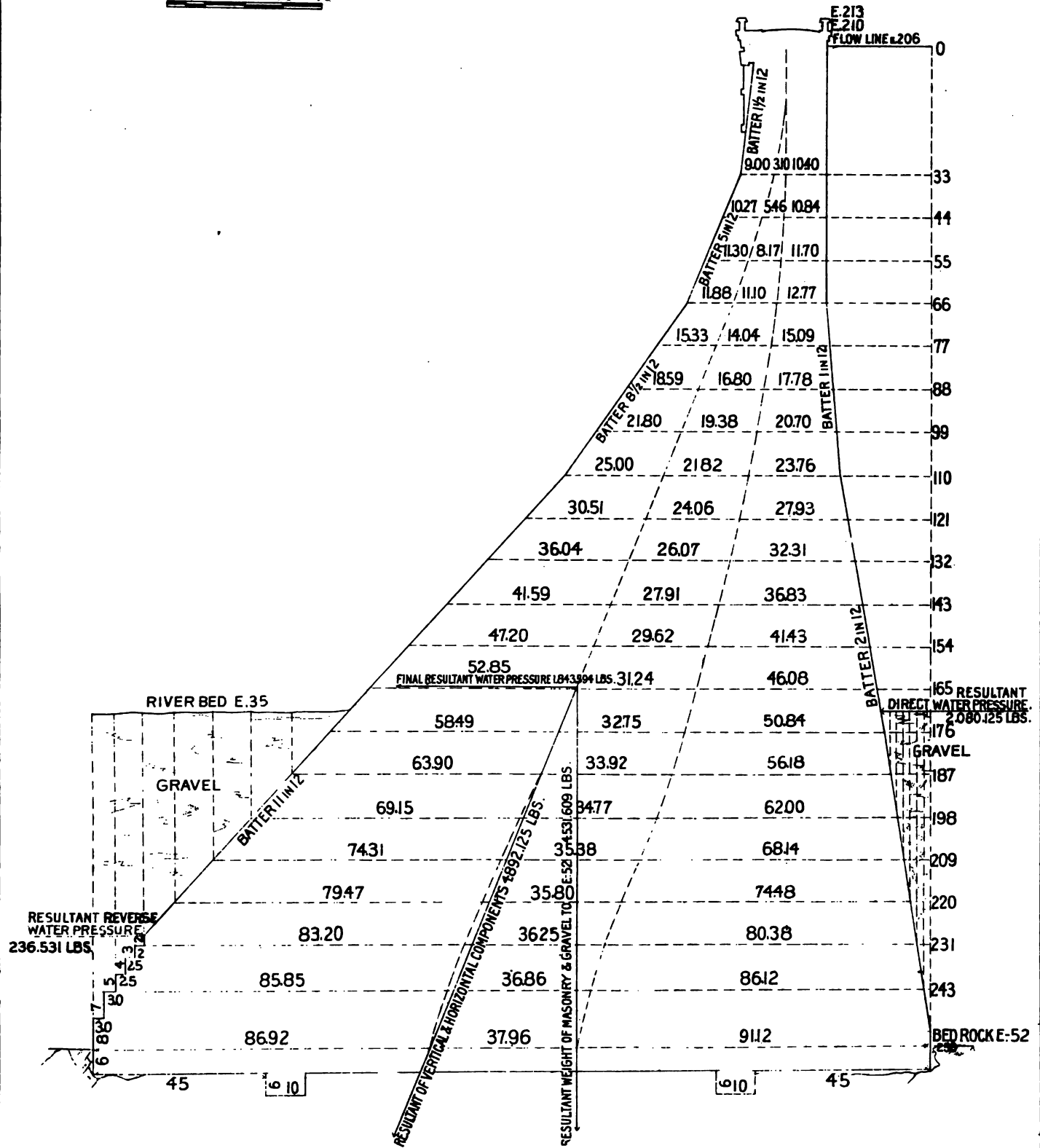
3

4



# QUAKER BRIDGE DAM

SCALE OF FEET.  
 0 5 10 20 30 40

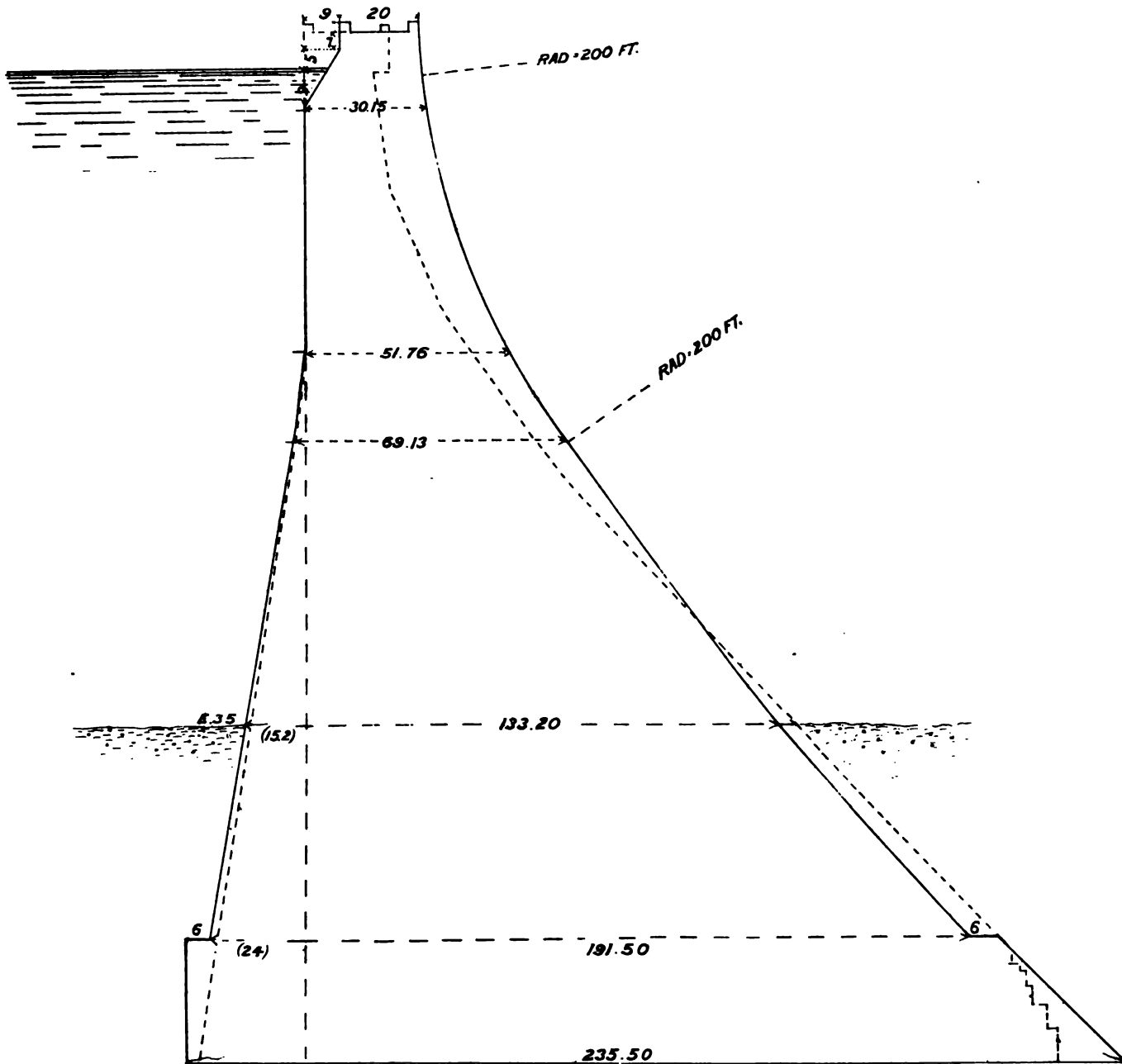
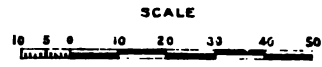


Vertical line of text on the left side of the page.

Small dark mark or artifact at the bottom left.

# PROFILE FOR QUAKER BRIDGE DAM

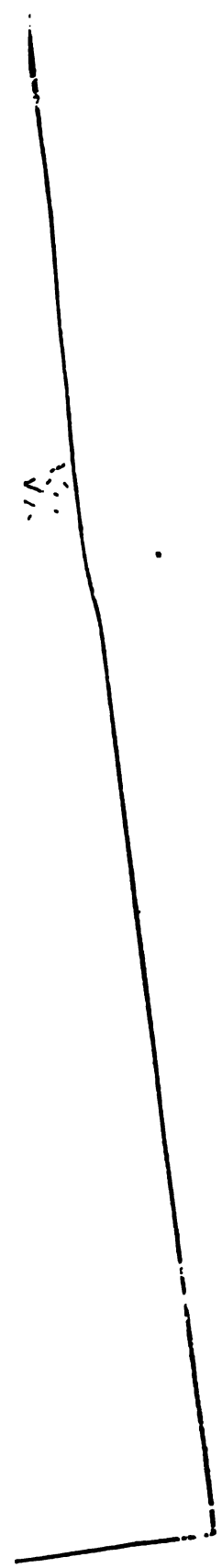
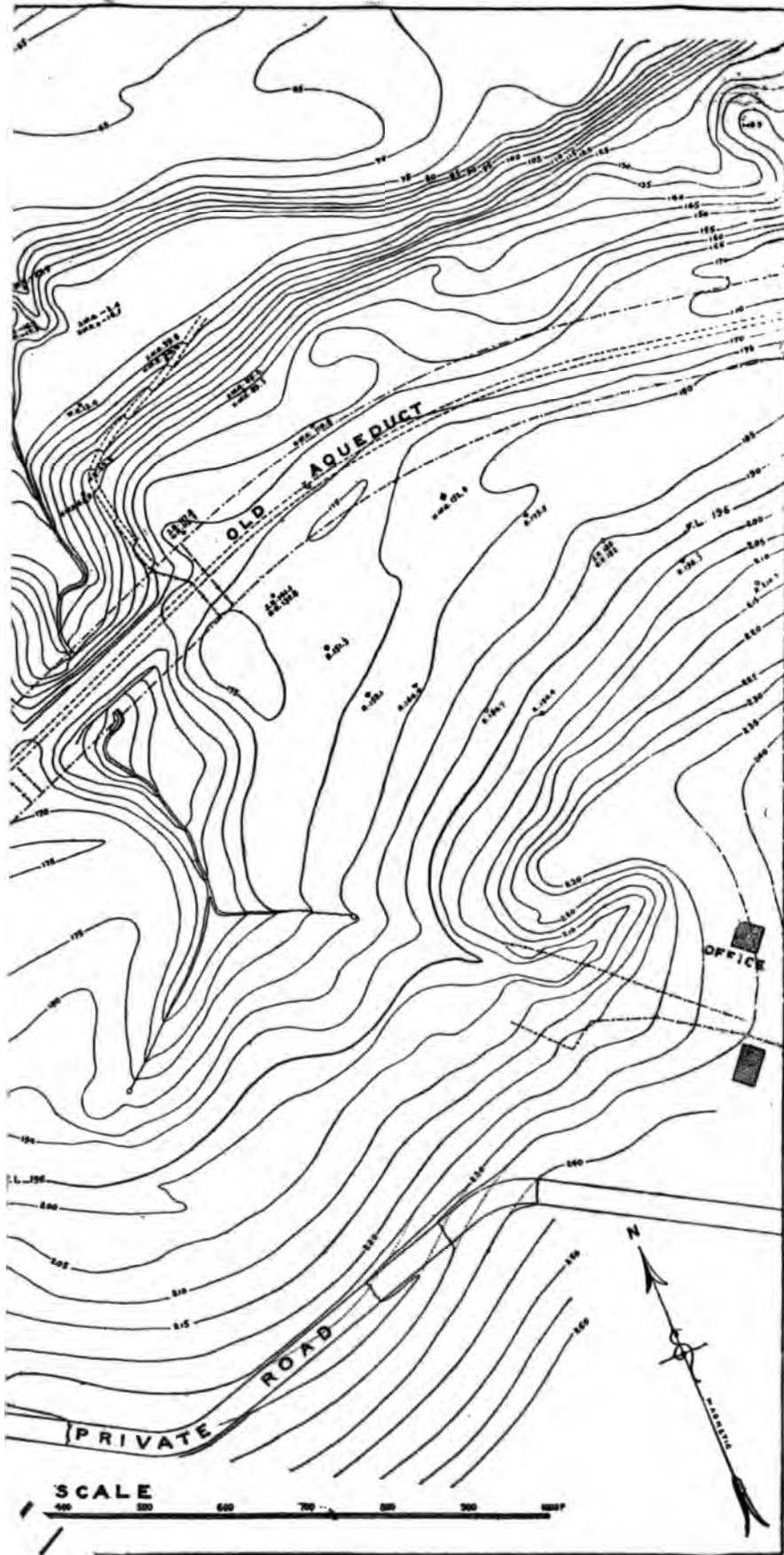
DESIGNED BY  
BOARD OF EXPERTS.



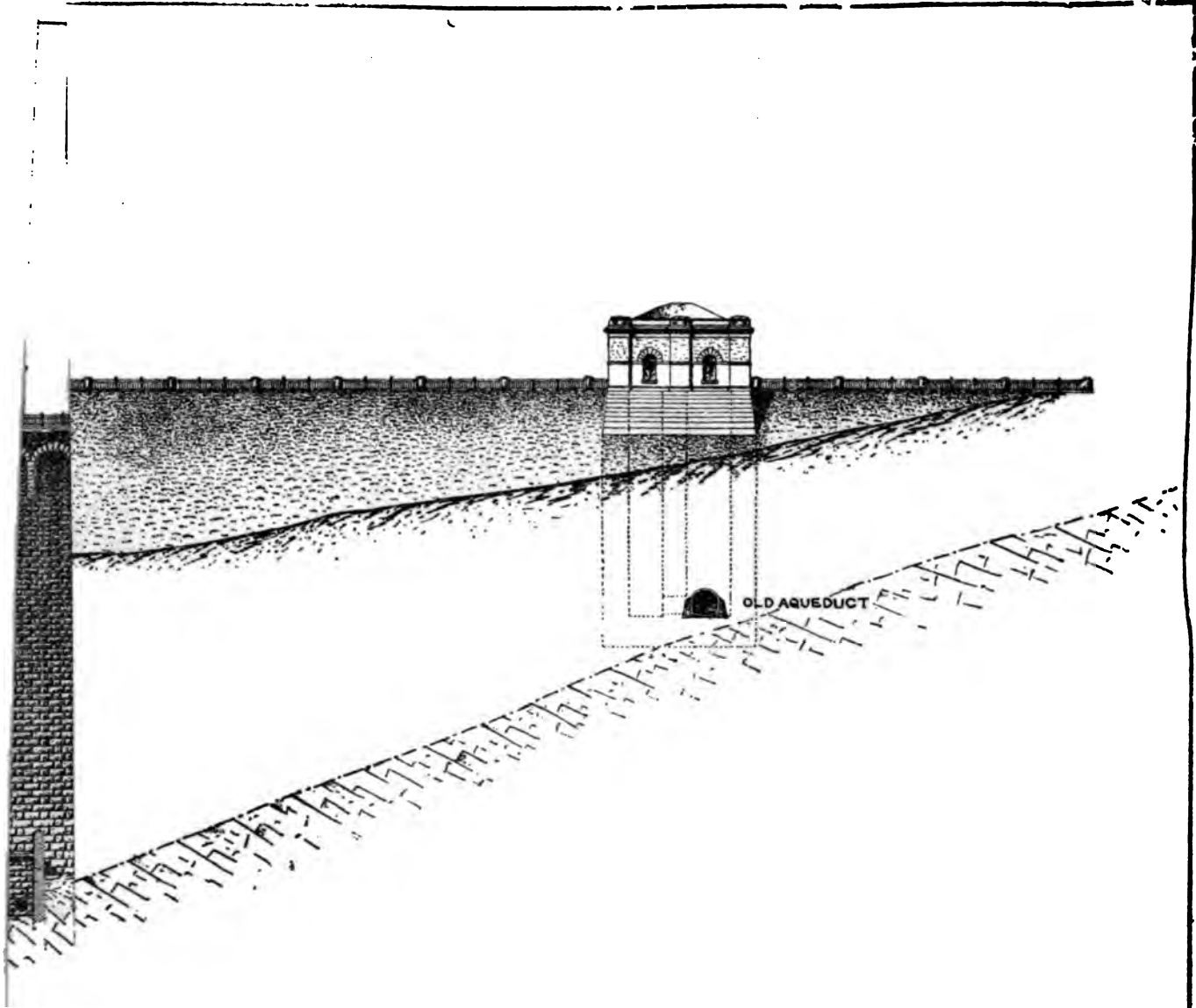
1

2

PLATE LXXX.







THE AQUEDUCT COMMISSIONERS  
NEW CROTON DAM  
AT  
CORNELL SITE

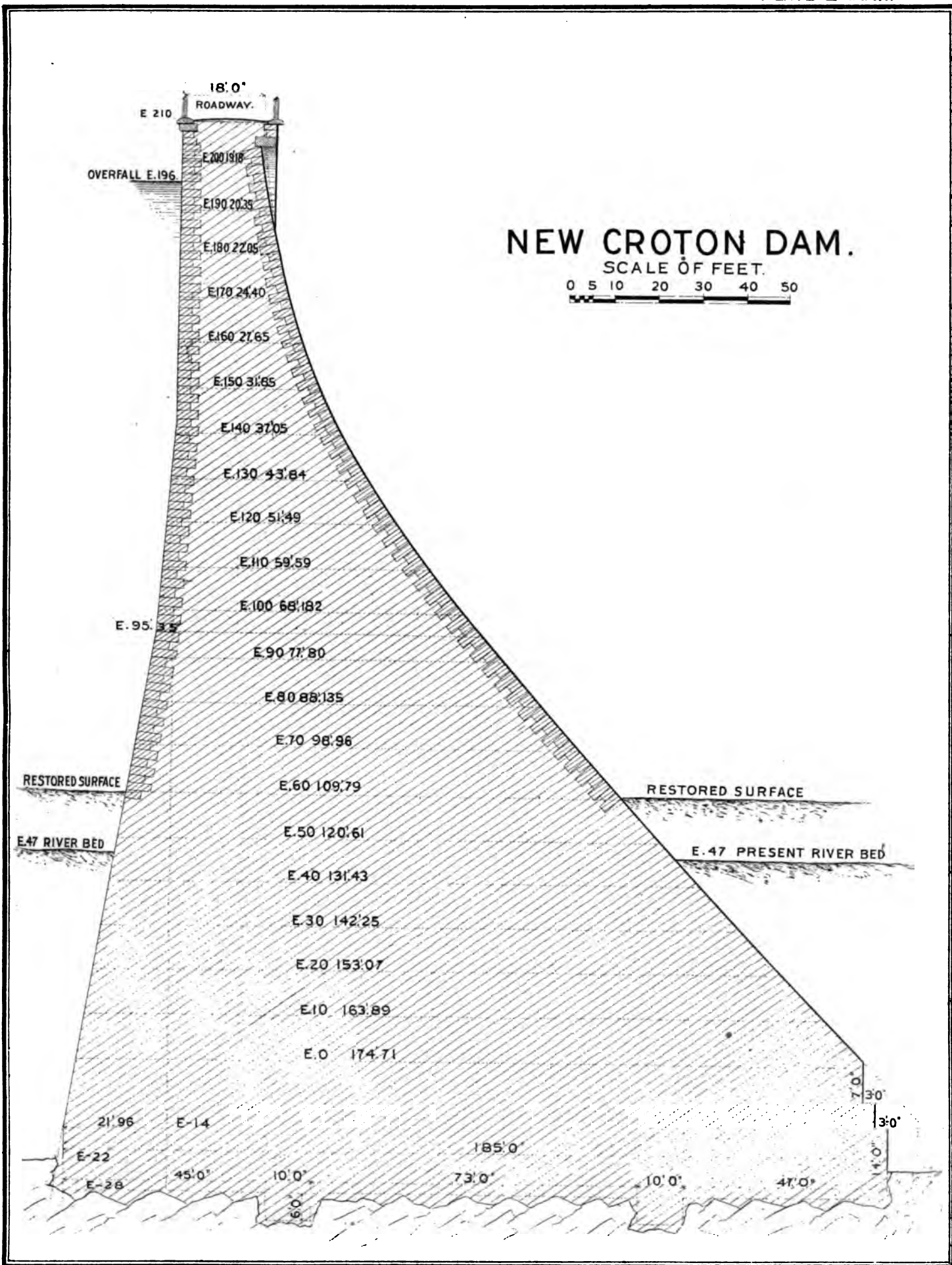


1

.







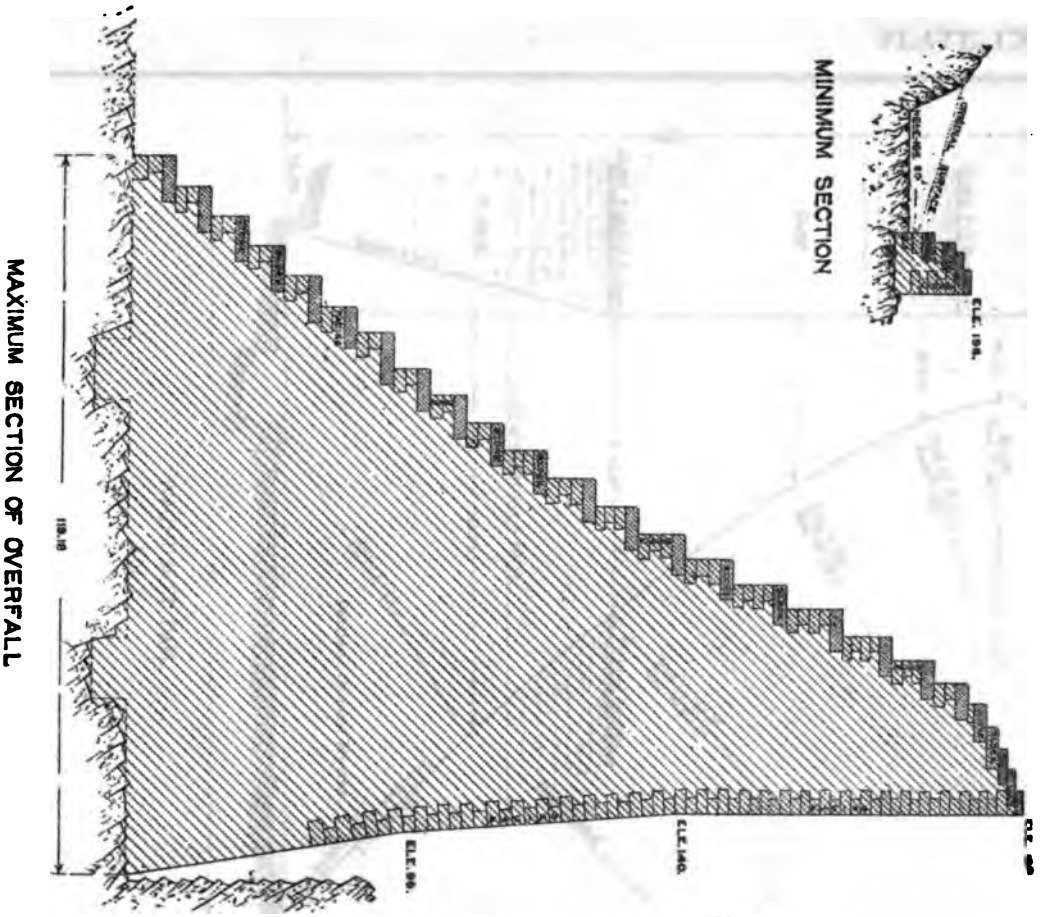


THE AQUEDUCT COMMISSIONERS  
NEW CROTON DAM.

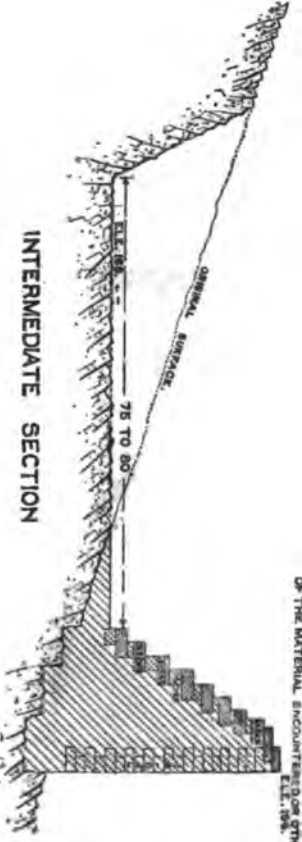
AT  
CORNELL SITE

SCALE 1" = 20'

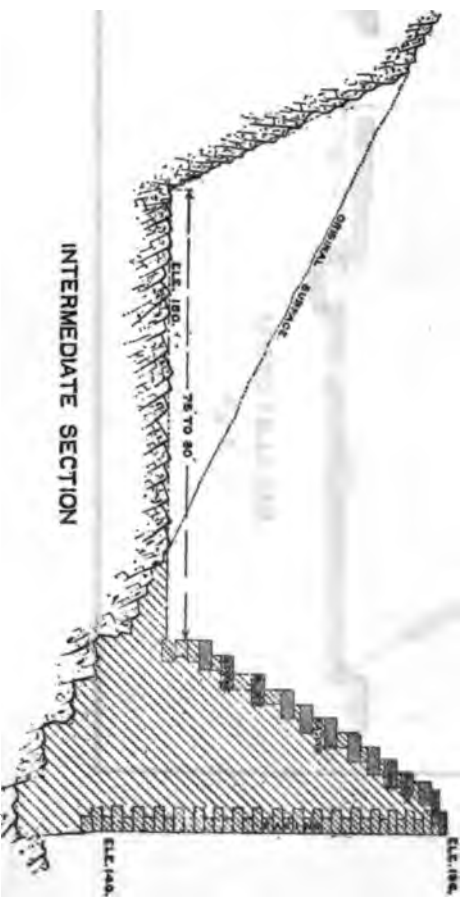
MINIMUM SECTION



MAXIMUM SECTION OF OVERFALL



INTERMEDIATE SECTION



INTERMEDIATE SECTION

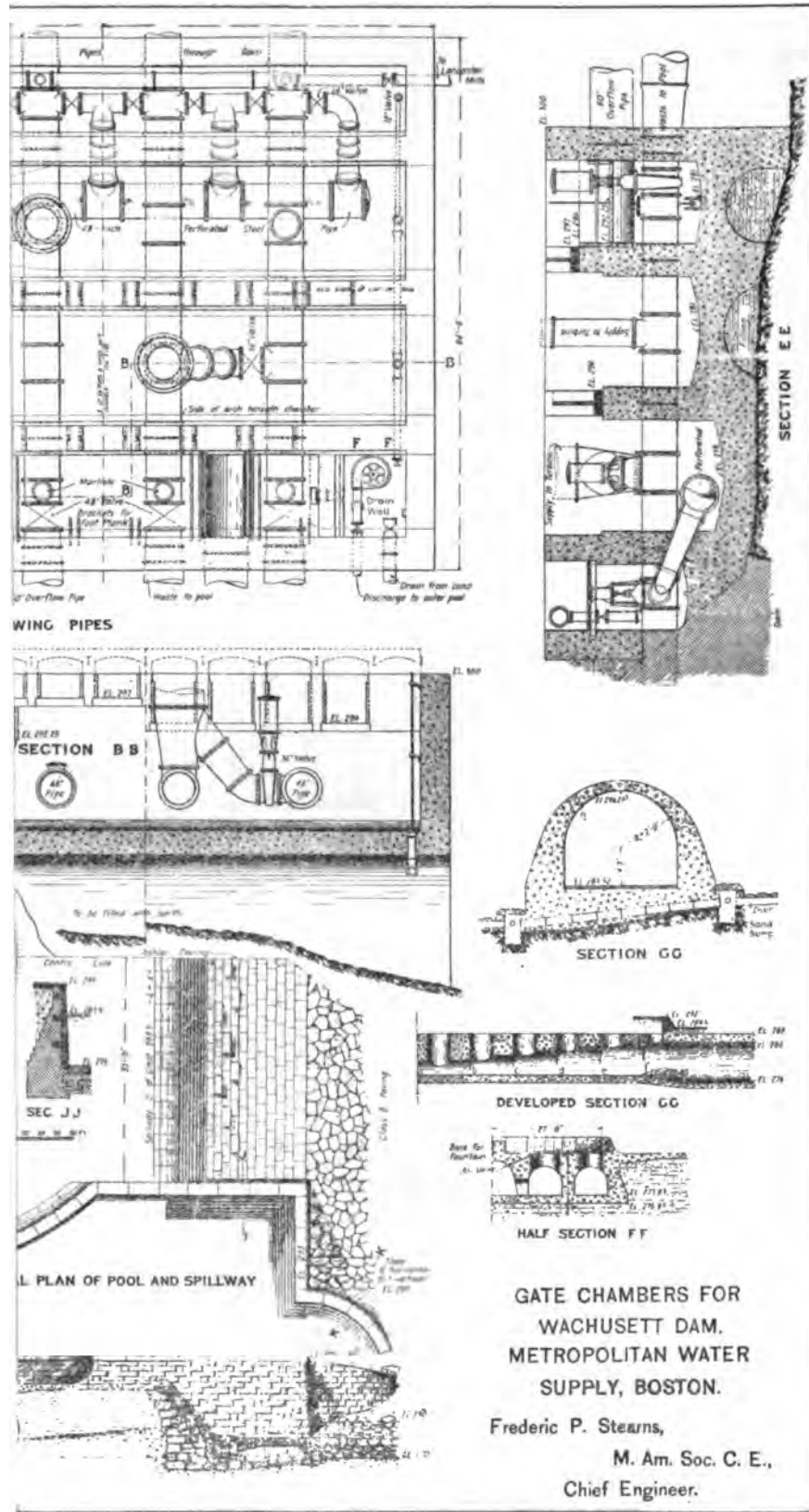
NOTE: THE WIDTH OF THE SPILLWAY CHANNEL, MAY BE INCREASED OR THE CONSTRUCTION, IF FOUND NECESSARY, DURING THE BUILDING OF THE MATERIALS SECTION. E.L. 98







PLATE LXXXV.



GATE CHAMBERS FOR  
WACHUSETT DAM.  
METROPOLITAN WATER  
SUPPLY, BOSTON.

Frederic P. Stearns,  
M. Am. Soc. C. E.,  
Chief Engineer.

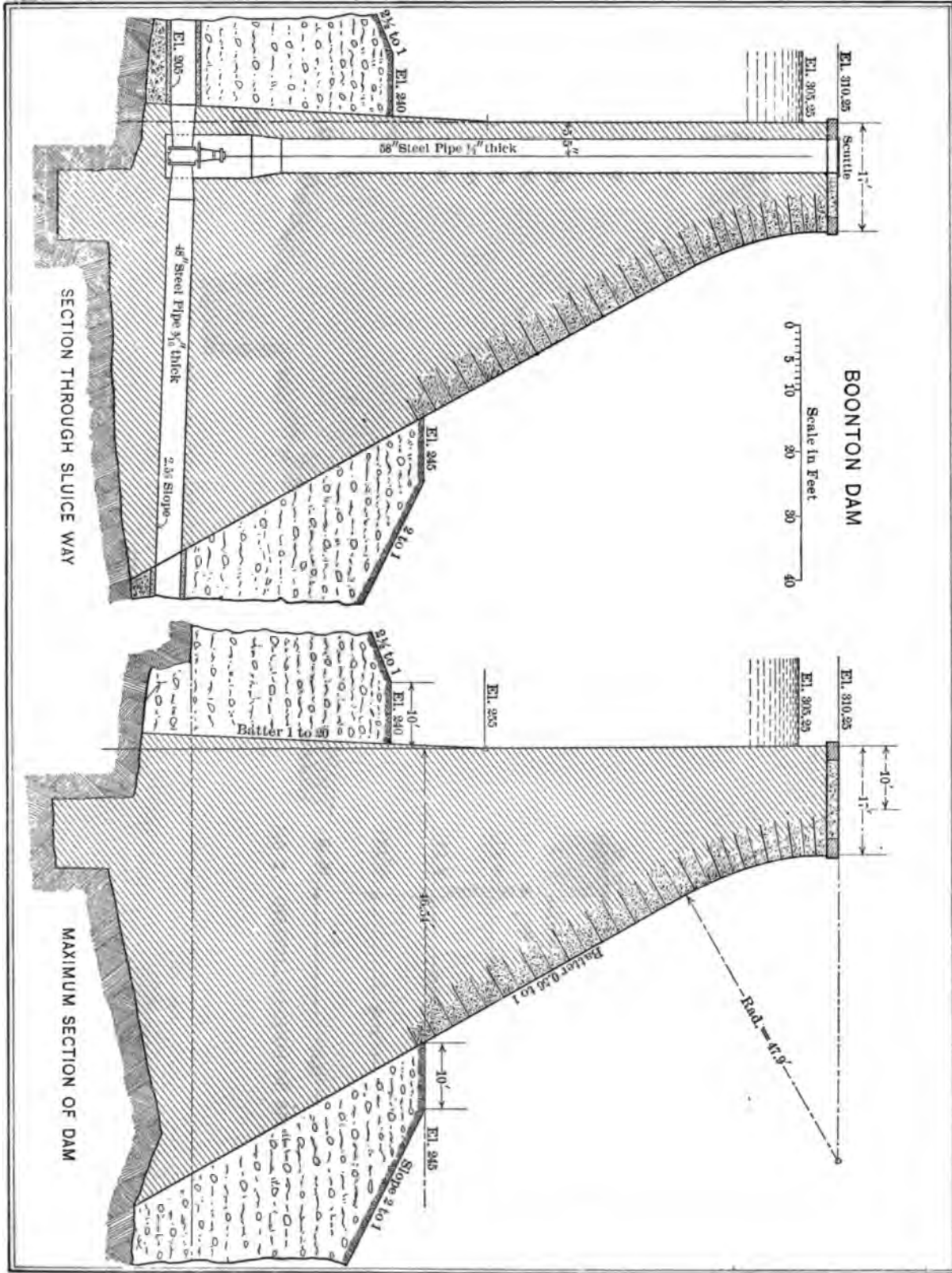
1

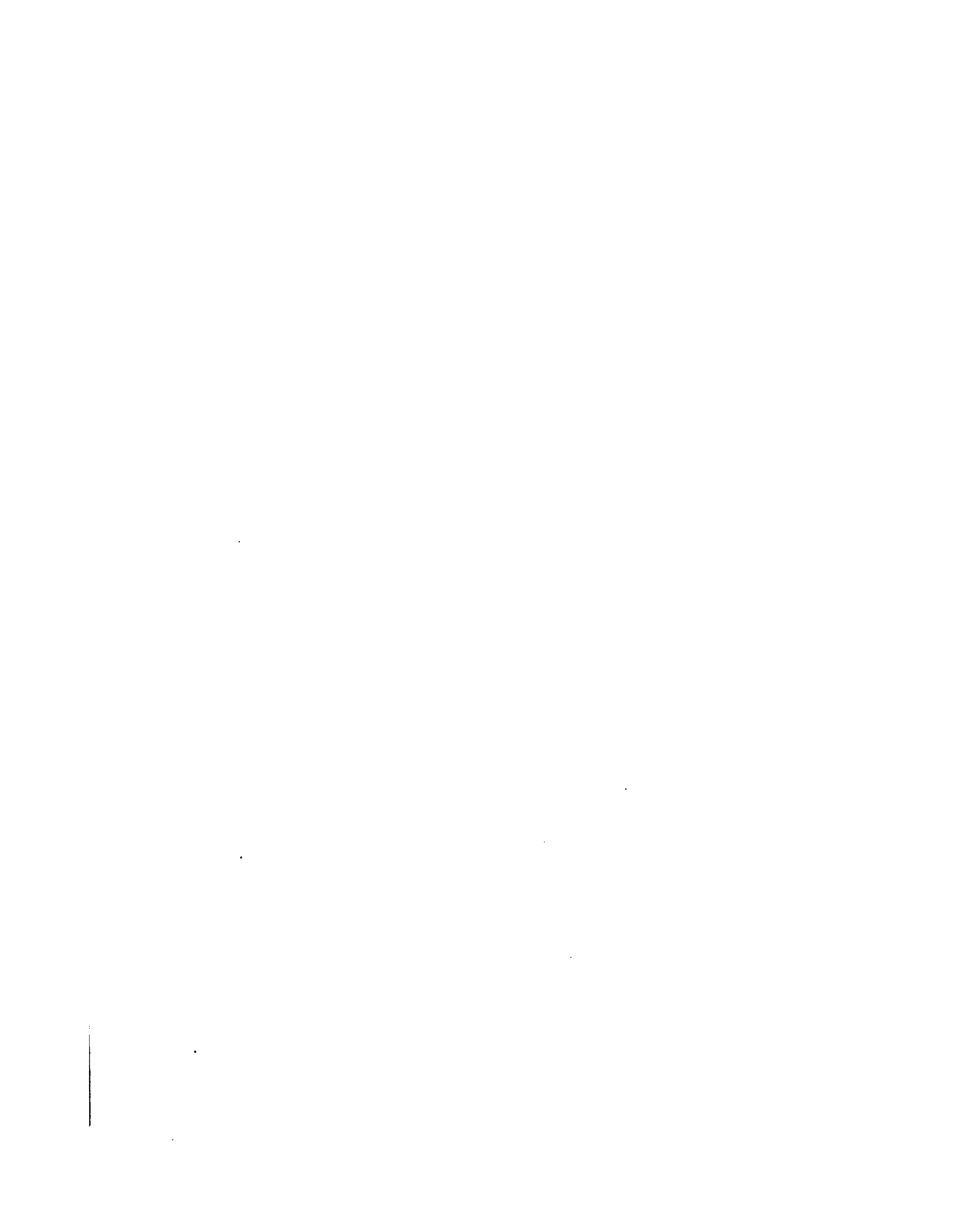
2

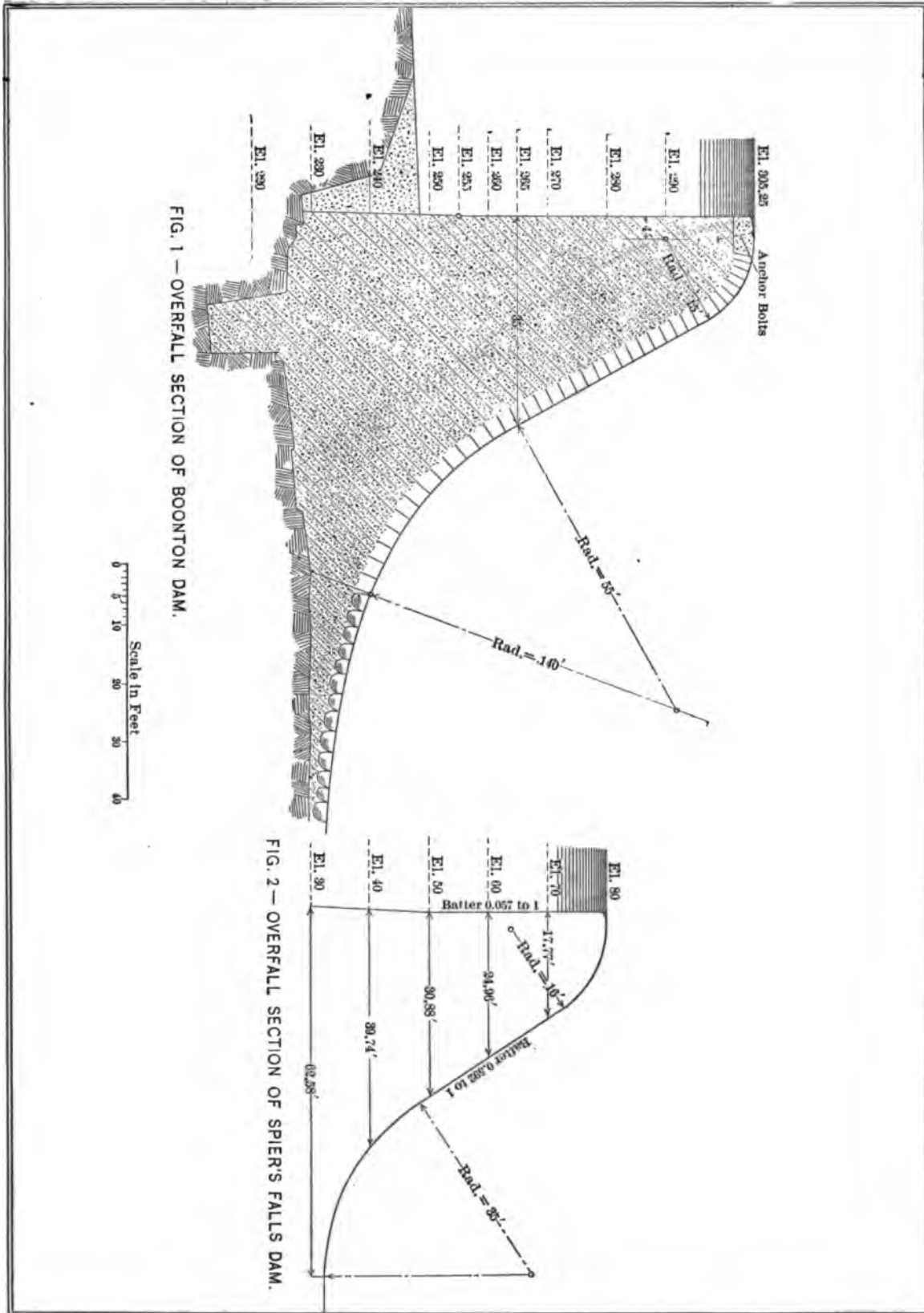
3

.









Vertical line on the left side of the page.



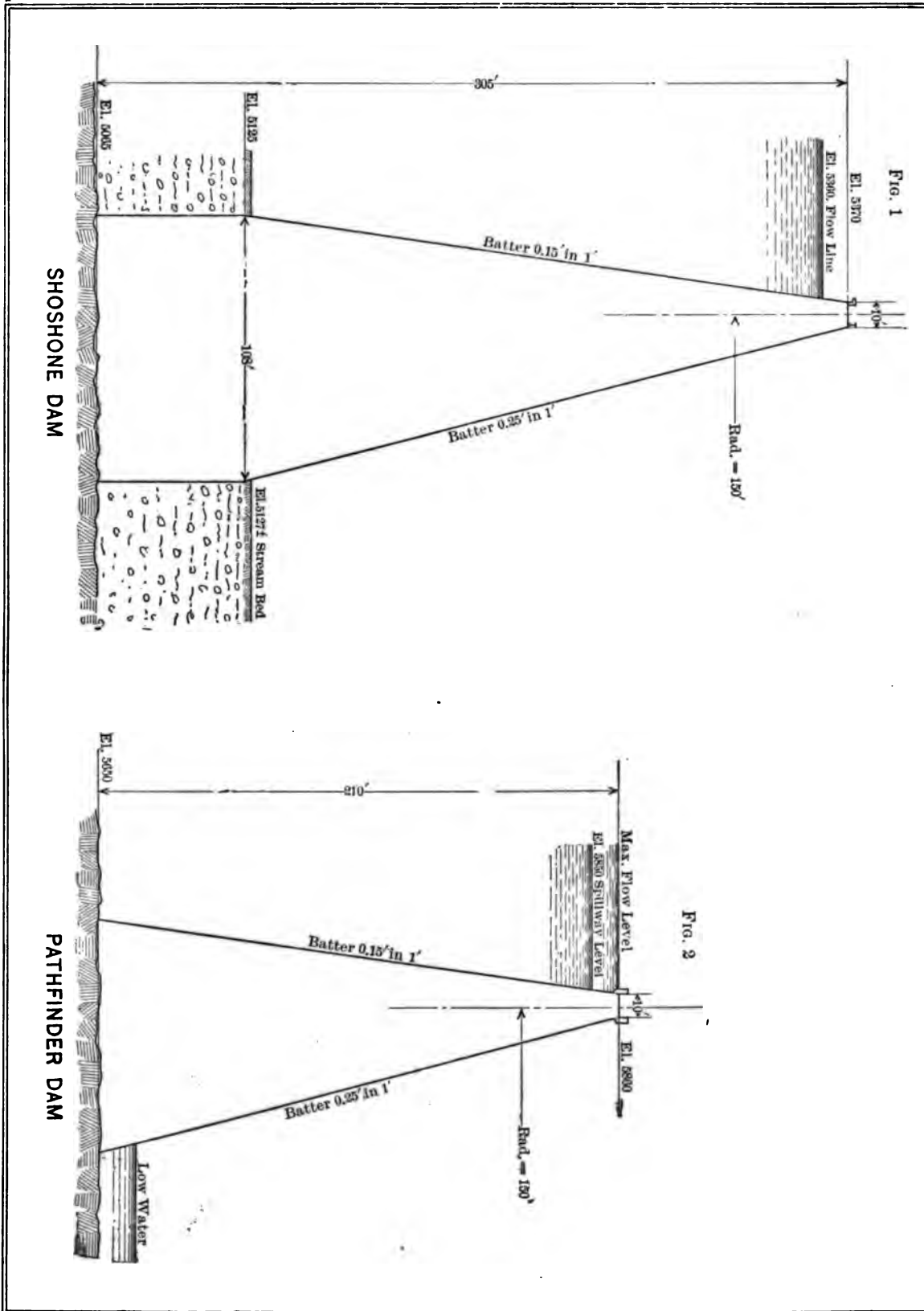
1

2

3

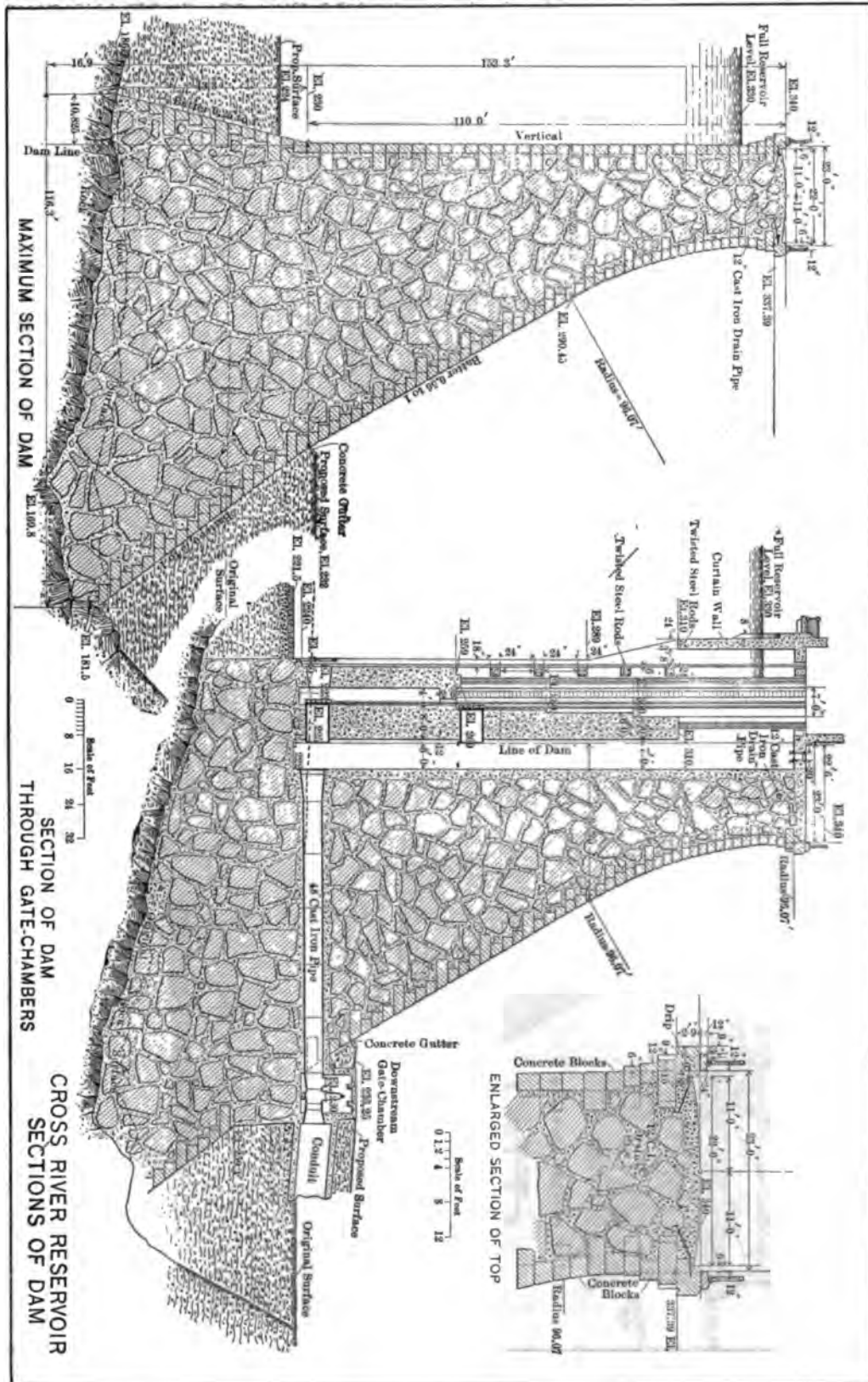
4

5







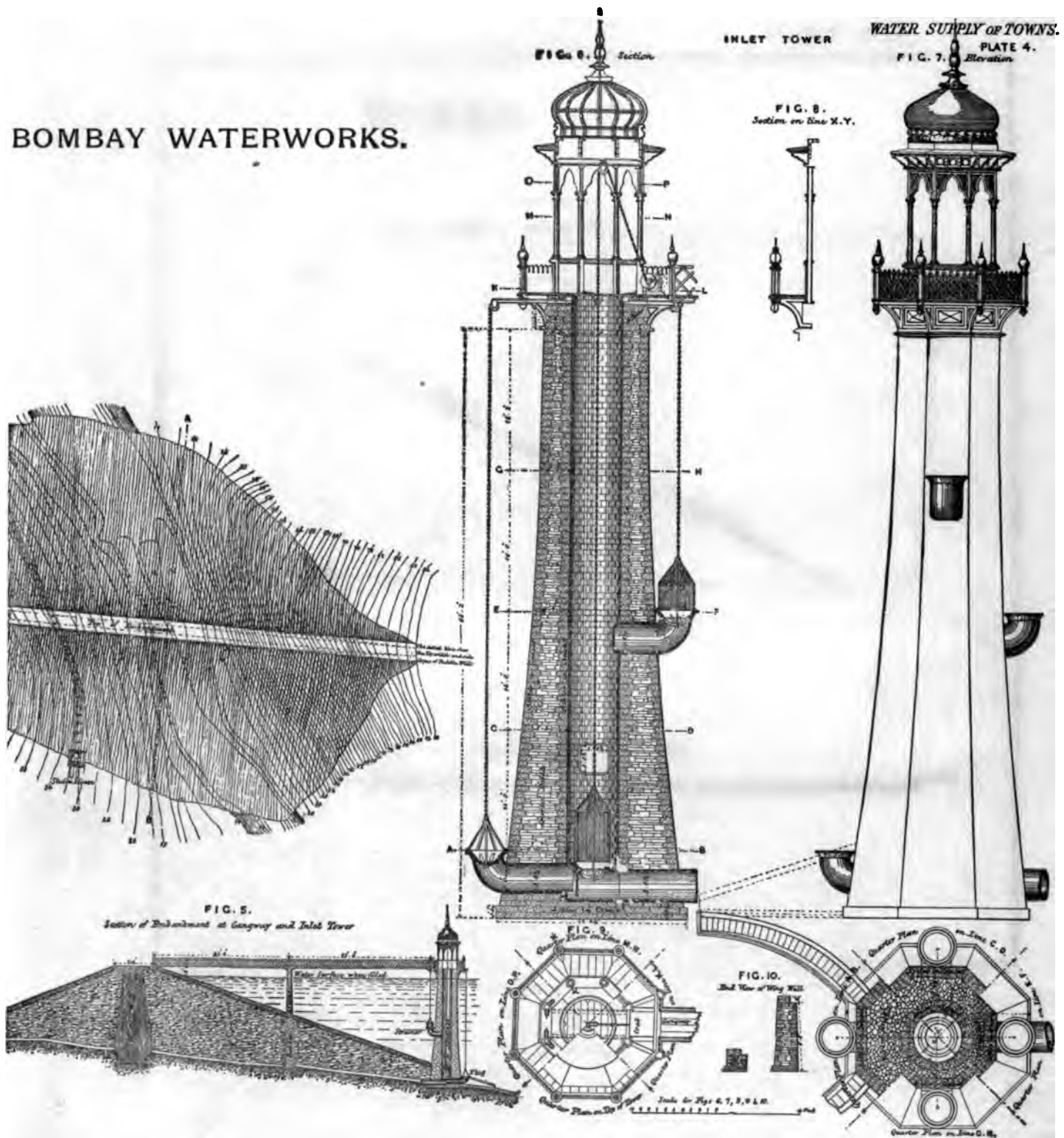






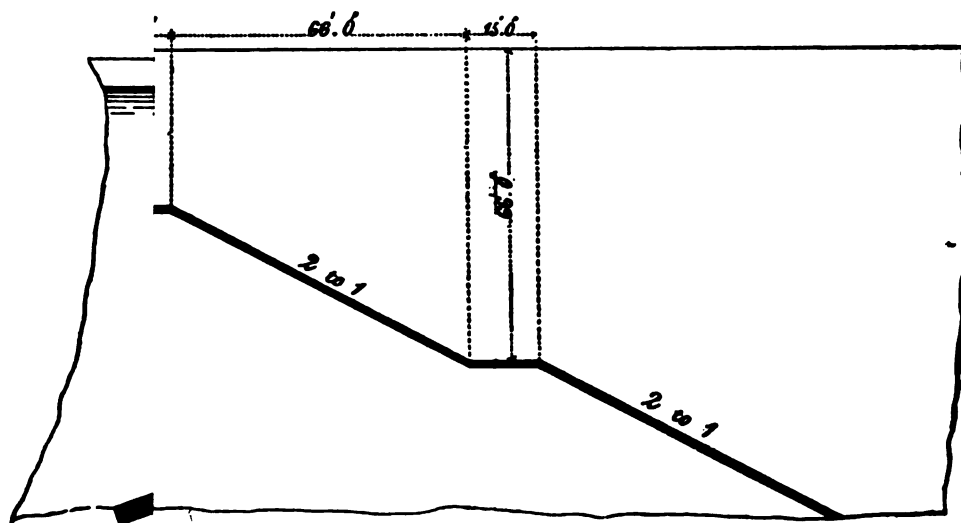


BOMBAY WATERWORKS.



1  
2  
3  
4  
5  
6  
7  
8  
9  
10  
11  
12  
13  
14  
15  
16  
17  
18  
19  
20  
21  
22  
23  
24  
25  
26  
27  
28  
29  
30  
31  
32  
33  
34  
35  
36  
37  
38  
39  
40  
41  
42  
43  
44  
45  
46  
47  
48  
49  
50  
51  
52  
53  
54  
55  
56  
57  
58  
59  
60  
61  
62  
63  
64  
65  
66  
67  
68  
69  
70  
71  
72  
73  
74  
75  
76  
77  
78  
79  
80  
81  
82  
83  
84  
85  
86  
87  
88  
89  
90  
91  
92  
93  
94  
95  
96  
97  
98  
99  
100

WORKS.



Scale 40 Feet to an Inch.



.....

.....











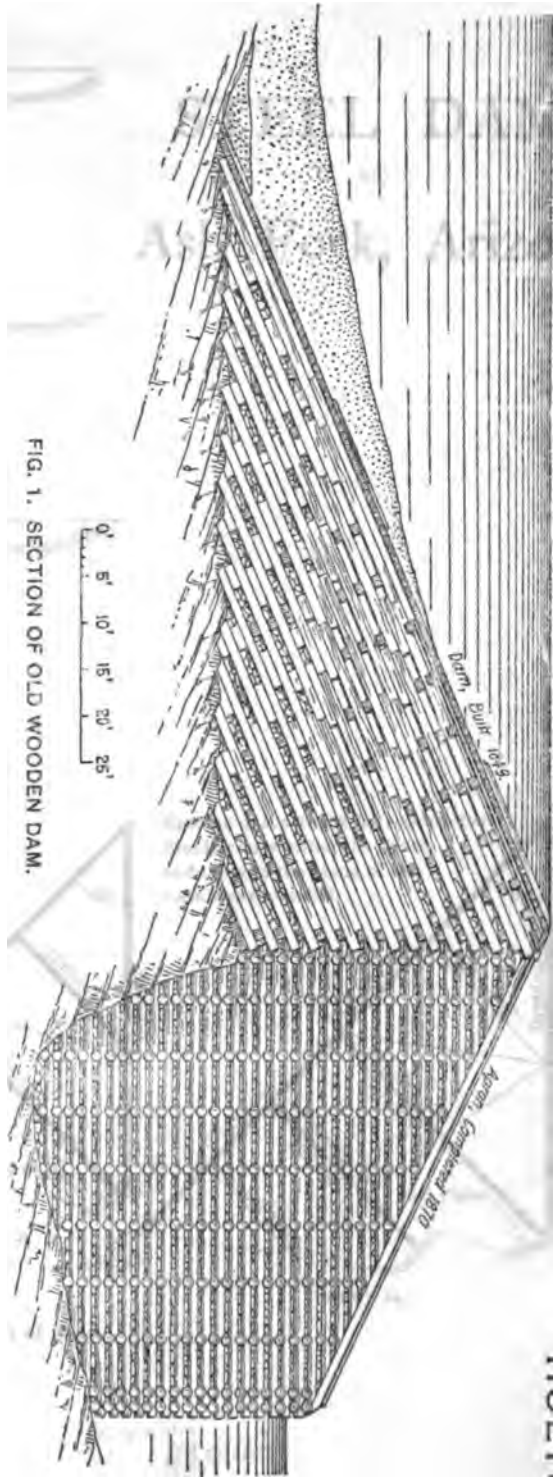


I



Vertical line of text on the left side of the page.

Small dot or mark in the center of the page.



HOLYOKE DAM.

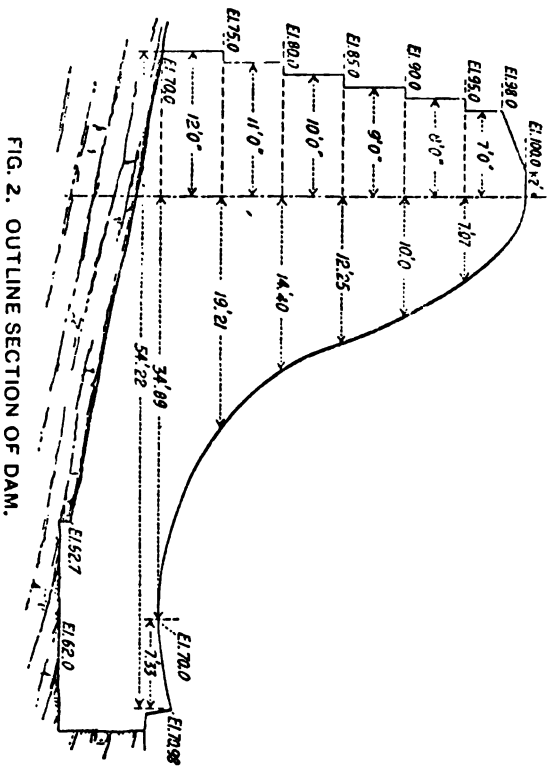
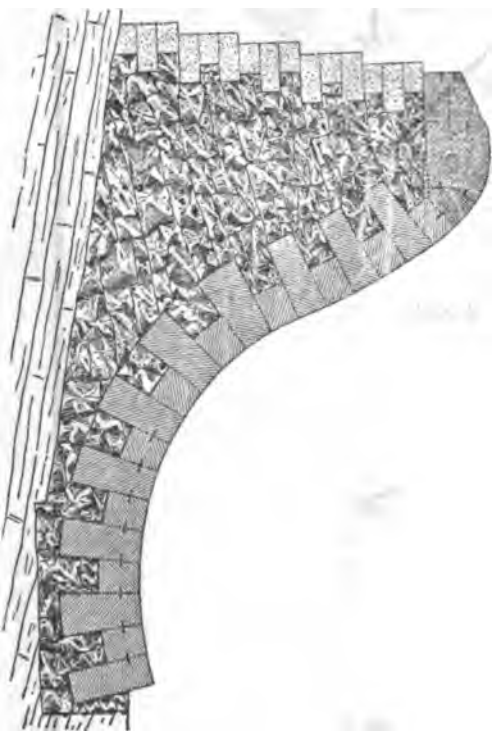


FIG. 3 CROSS SECTION OF DAM.







# STEEL DAM AT Ash Fork, Arizona

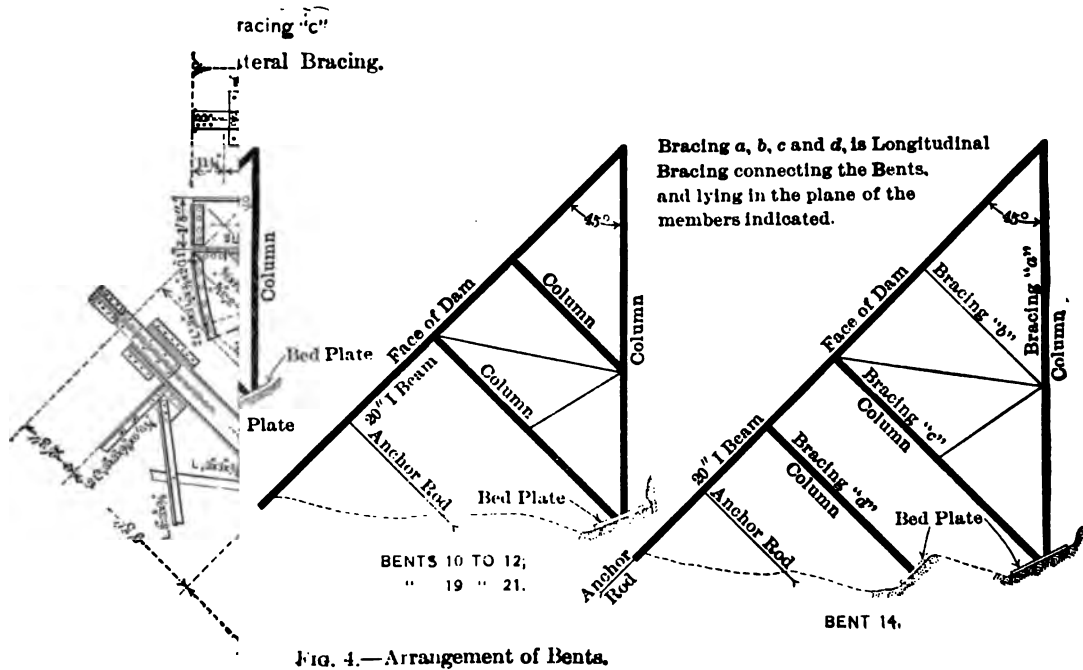
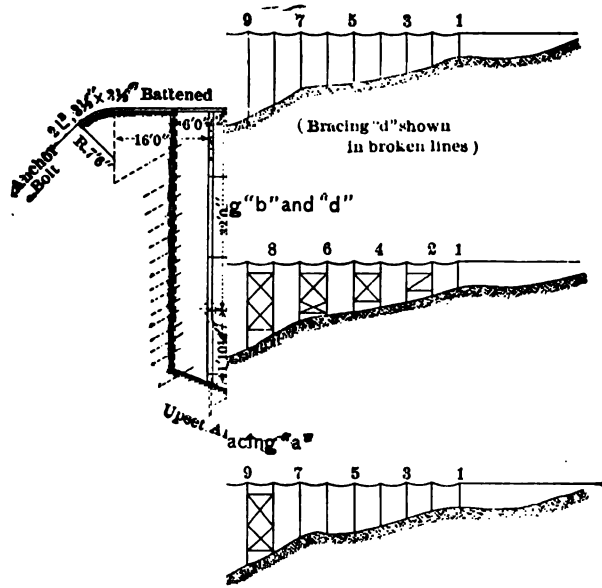


FIG. 4.—Arrangement of Bents.

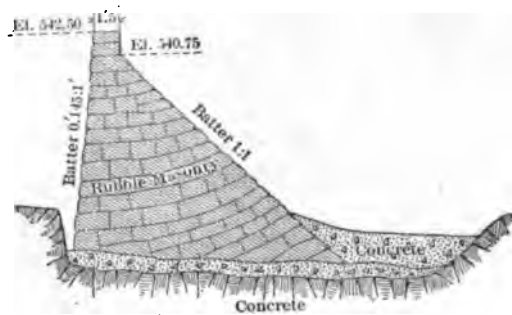


FIG. 6.—Section of Masonry Abutment.



