



POST-TENSIONING INSTITUTE
Stressing the Stronger Concrete Solution™

TAB.3-13 Post-Tensioning Terminology (PTT)

PTI Technical Advisory Board

The following Post-Tensioning Terminology (PTT) document contains the consensus definitions for terms relating to the post-tensioning field.

To Committee Members: Please use these definitions when drafting or revising a document. If a definition is present in the PTT, please do not define it again, but refer to the PTT document in the definition section. If the committee feels that a definition beyond the PTT is required, please draft the definition and forward to PTI staff. If the committee feels that a term needs to be added or an existing definition needs modification, please email PTI staff with the request. All requests for modification will be considered by TAB.

Table of Contents

Components 1

Equipment 22

Tendon Stressing..... 25

Design 26

Troubleshooting / Repair 30

Concrete / Grouting Materials 32

Index 33

Components

Anchor



For unbonded single strand tendons, a device that houses the wedges and transfers the prestressing force to the concrete.

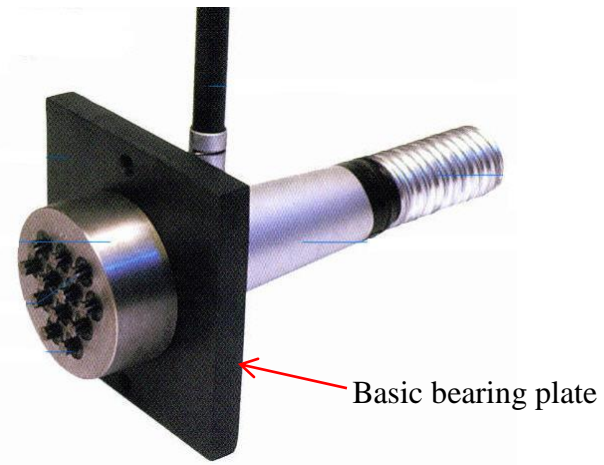
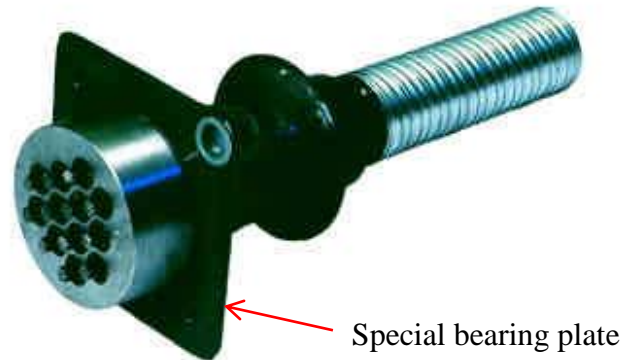

Anchor

Wedge cavity (single strand anchor)

<p>Bearing plate, basic</p>	<p>Flat steel plate that transfers the tendon force directly into the concrete, meeting the analytical design requirements of PTI “Acceptance Standards for Post-Tensioning Systems,” Section 3.1.</p> 
<p>Bearing plate, special</p>	<p>Any hardware that transfers tendon force into the concrete and does not meet the analytical design requirements of PTI “Acceptance Standards for Post-Tensioning Systems,” Section 3.1. Typically includes spiral confinement reinforcement.</p> 

<p>Anchor, barrel</p>	<p>A special anchor used for single strand tendons, consisting of a cylindrical metal device housing the wedges. Normally used with a bearing plate to transfer the prestressing force to the concrete. Also used with miscellaneous steel members in barrier cable applications.</p>  <p>Barrel Anchor with wedges</p>
<p>Anchor nut</p>	<p>Threaded device that screws onto a threaded stress bar and transfers the force from the bar to the bearing plate.</p>  <p>Anchor nut</p>

Anchorage (assembly)

A mechanical device consisting of all components required to transfer the post-tensioning force from the prestressing steel to the structure, including all accessories for encapsulation or grouting.

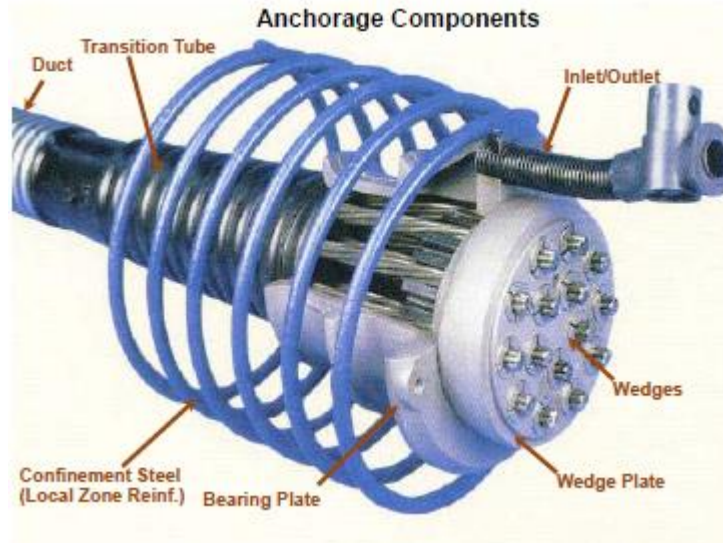

Anchorage (assembly) for multistrand tendons

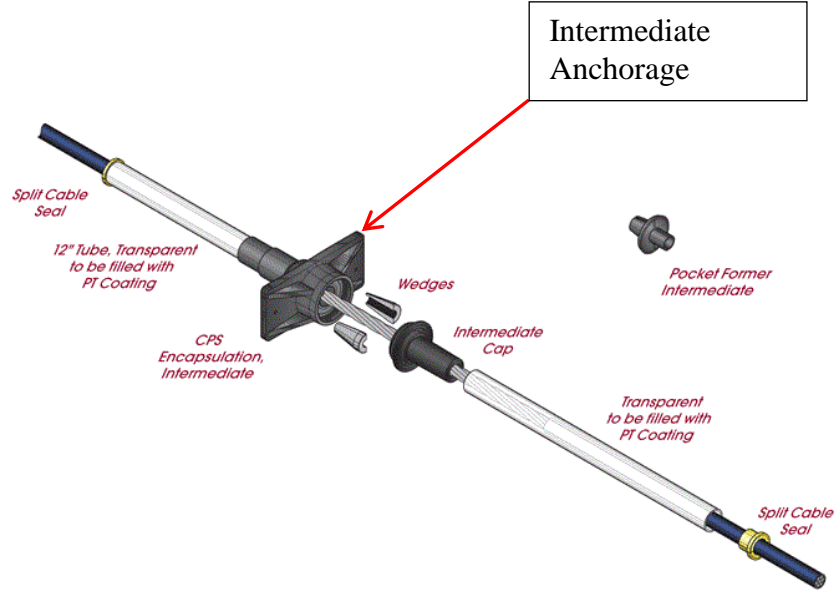

Anchorage (assembly) for single strand tendons

<p>Anchorage, intermediate</p>	<p>The anchorage located at any point along the tendon used to stress only a portion of the tendon at a construction joint. The tendon may be continuous or spliced at that location.</p>  <p>The diagram illustrates the components of an intermediate anchorage. A central tendon is shown with a blue 'Split Cable Seal' at each end. The tendon passes through a '12 inch Tube, Transparent to be filled with PT Coating'. This tube is secured by a 'CPS Encapsulation, Intermediate' and an 'Intermediate Cap'. 'Wedges' are used to secure the tendon within the tube. A 'Pocket Former Intermediate' is also shown as a separate component. A red arrow points from a box labeled 'Intermediate Anchorage' to the central assembly.</p>
--------------------------------	---

Anchorage, fixed

The anchorage that is not used for stressing of the tendon. For unbonded single strand tendons, this anchorage is normally attached to the tendon at the plant.



Fixed





Fixed Anchorage



Anchorage,
stressing

The anchorage at one or both ends of a tendon that is used for stressing.



<p>Back-up bars</p>	<p>For unbonded single strand tendons, minimum nonprestressed reinforcement parallel to slab edge used to resist tensile forces in the concrete caused by the applied prestressing force.</p>   <p>Back-up Bars</p> <p>Back-up Bars</p>
---------------------	--







<p>Bursting steel</p>	<p>For unbonded single strand tendons, nonprestressed reinforcement used to resist the tensile forces in the concrete caused by the applied prestressing force from multiple anchorages.</p>  <p>Bursting Steel</p>
-----------------------	---

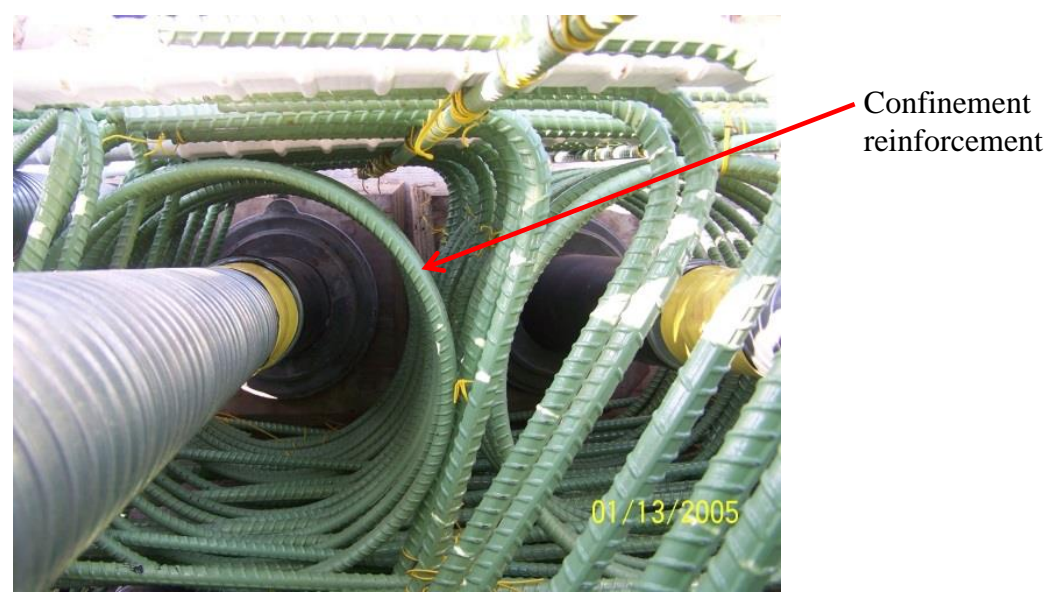
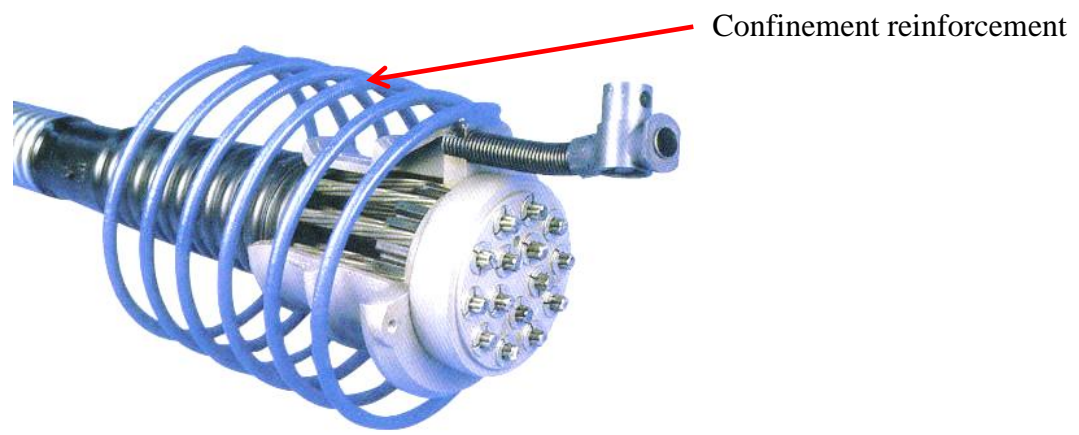

Confinement reinforcement

Nonprestressed reinforcement, typically a spiral, in the local anchorage zone.



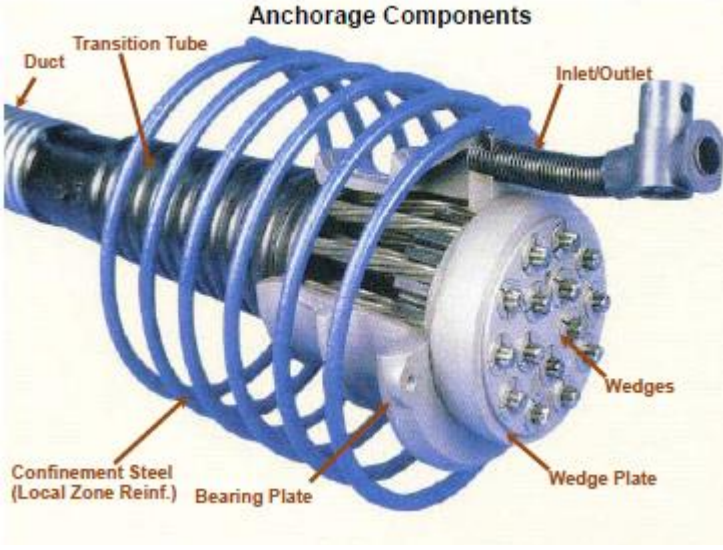

<p>Duct</p>	<p>A conduit to accommodate prestressing steel installation and provide an annular space for grouting.</p>  <p>Metal duct</p>  <p>Plastic duct</p>  <p>Plastic duct</p>
<p>Inlet</p>	<p>Tubing with connection to duct used for injection of the grout into the duct.</p>

Local zone reinforcement	For multistrand tendons, nonprestressed reinforcement used as confinement reinforcement of the local anchorage zone.
Monostrand (Single Strand)	<p data-bbox="381 346 690 378">Tendon with one strand.</p>  

<p>Multistrand</p>	<p>Tendon with more than one strand.</p>  <p>The diagram, titled "Anchorage Components", shows a cross-section of a tendon anchor. It features a central "Duct" surrounded by a "Transition Tube" and "Confinement Steel (Local Zone Reinf.)". The tendon ends are secured by "Wedges" on a "Wedge Plate", which sits on a "Bearing Plate". An "Inlet/Outlet" is attached to the side of the anchor.</p>
<p>Outlet</p>	<p>Tubing with connection to duct used to allow the escape of air, grout, and bleed water from the duct.</p>
<p>Pocket former</p>	<p>A device that forms a temporary recess in the concrete to allow access for stressing.</p>  <p>The photograph shows two white plastic "Pocket Formers" mounted on a metal bar. Each former has a black top cap and a vertical opening. A red arrow points to the right-hand former, which is labeled "Pocket Former".</p>

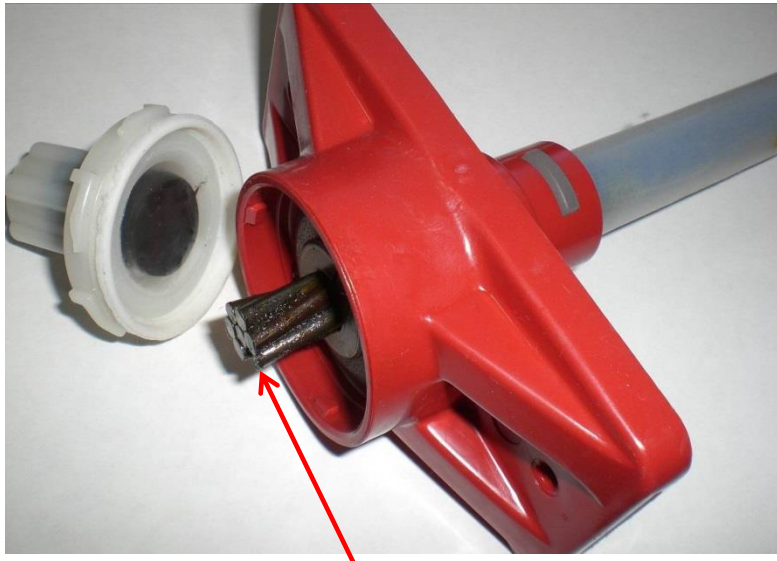
<p>Sheathing</p>	<p>For unbonded single strand tendons, an enclosure in which prestressing steel is encased to prevent bond with surrounding concrete that provides corrosion protection and contains PT coating.</p>  <p>Sheathing</p>
<p>Slab bolster</p>	<p>Continuous hardware used to support and hold post-tensioning tendons and reinforcing steel in place before and during concrete placement.</p>
<p>Strand</p>	<p>High strength steel wires wound around a center wire, typically seven-wire strand, conforming to ASTM A416/A416M.</p> 

<p>Strand tail</p>	<p>The protruding length of the strand outside of the wedges that remains in place after the tendon tail has been cut off.</p>  <p>Strand Tail</p>
<p>Stress bar</p>	<p>High strength steel bar used in post-tensioning conforming to ASTM A722 / A722 M.</p> 

<p>Stressing pocket</p>	<p>The recess created by the pocket former between the stressing or intermediate anchorage and the edge of the concrete to allow the nosepiece access for stressing.</p>  <p>Stressing Pocket</p>
<p>Tendon</p>	<p>A complete assembly of a prestressing element consisting of anchorages and couplers, prestressing steel, and sheathing or duct with PT coating for unbonded applications or grouted ducts, grout caps, and grout vents for bonded applications.</p>
<p>Bonded tendon</p>	<p>Tendon in which prestressing steel is bonded to the concrete and is permanently prevented from moving relatively to the concrete.</p>
<p>Unbonded tendon</p>	<p>Tendon in which the prestressing steel is prevented from bonding to the concrete, and is permanently free to move relatively to the concrete. The prestressing force is transferred to the concrete only by the anchorages or deviators.</p>

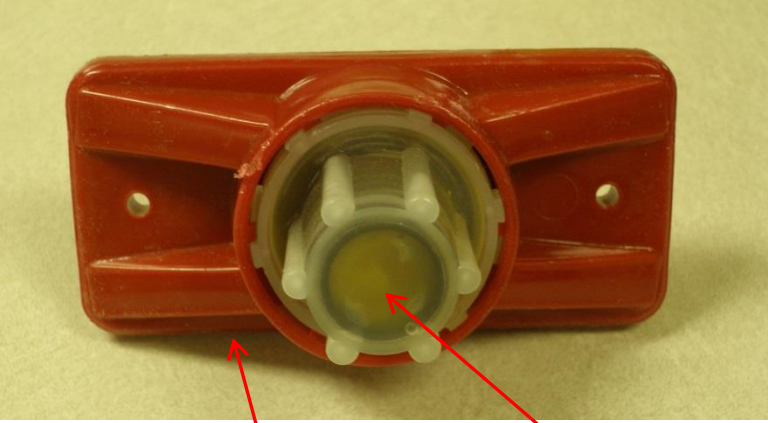
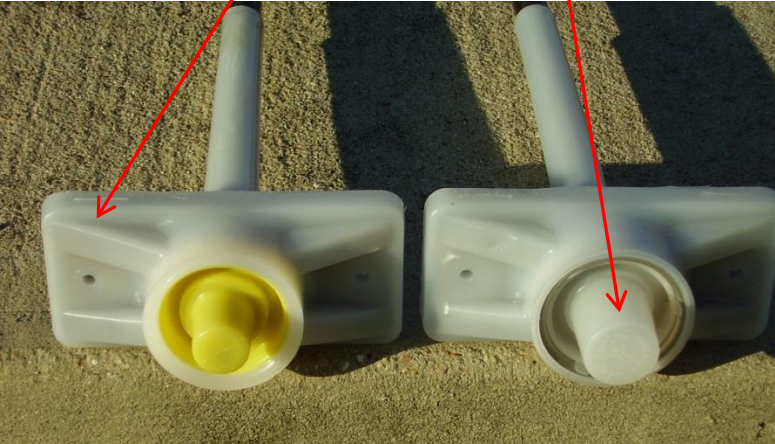
<p>Encapsulated tendon</p>	<p>A tendon that is completely enclosed in a watertight covering from end to end, including anchorages, sheathing with PT coating and an encapsulation cap over the strand tail at each end.</p>  <p>Encapsulated Anchor Encapsulation Cap</p> 
<p>Temperature tendon</p>	<p>Tendon used to resist shrinkage and temperature stresses.</p>
<p>Added tendon</p>	<p>Tendon, usually short in length, added to continuous tendons and placed in specific locations, such as end bays, to increase the local prestressing force.</p>

Banded tendons

Closely spaced groups of tendons in a narrow strip in one direction in two-way floor systems, typically centered on column or support lines.



 Banded Tendons

Distributed tendons

Single tendon or groups of tendons, uniformly spaced in one direction, typically perpendicular to banded tendons or to beams.



 Distributed Tendons

Tendon tail

The protruding length of the tendon outside of the stressing anchorage needed temporarily for stressing of the tendon.

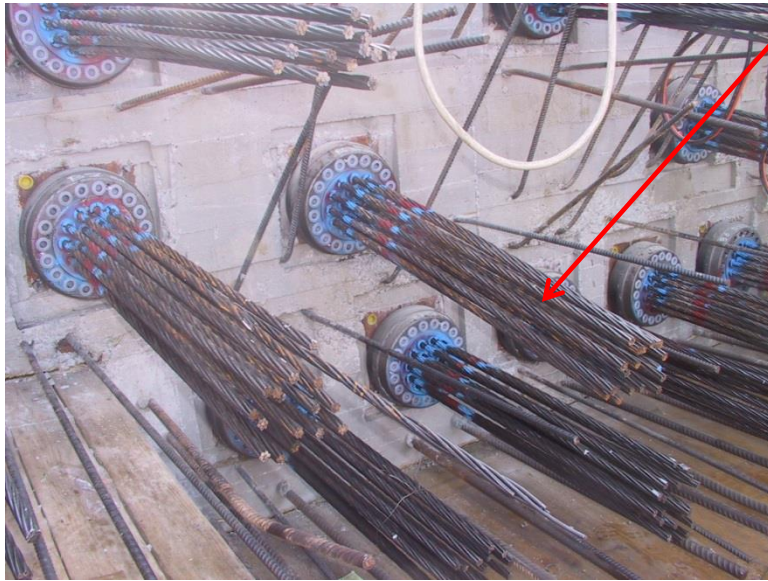
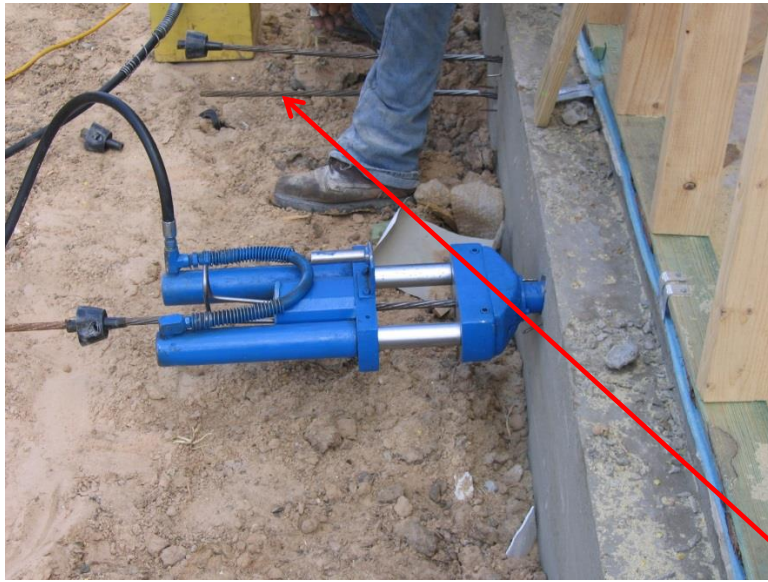

Tendon Tail

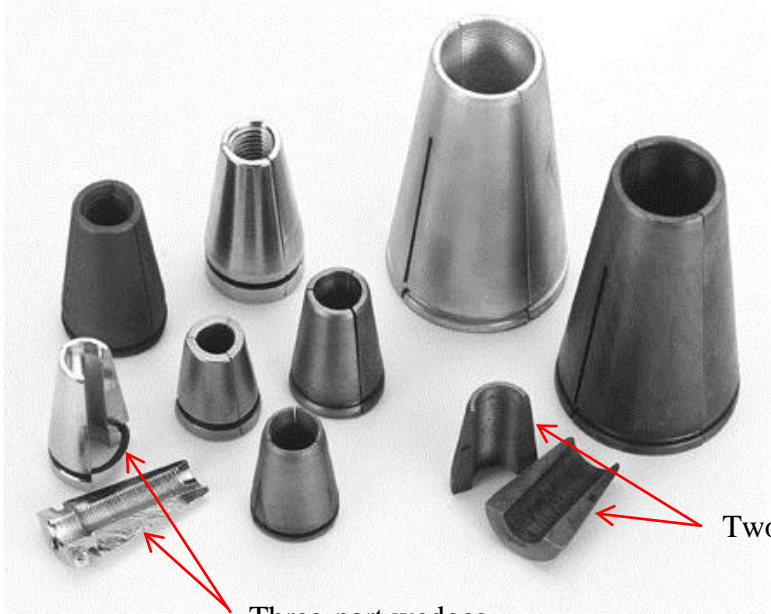
<p>Trumpet</p>	<p>Connection piece between bearing plate and duct, in which the strands transition from the wedge plate pattern into a tight bundle inside the duct.</p>  <p>Trumpet</p>
<p>Wedges</p>	<p>Pieces of tapered high-strength heat-treated steel with serrations (teeth) that penetrate the prestressing steel during transfer of prestressing force. Some anchorage systems use two-part wedges and some use three-part wedges.</p>  <p>Two-part wedges</p> <p>Three-part wedges</p>
<p>Wedge cavity</p>	<p>The tapered opening in the anchor or wedge plate designed to allow the strand passing through and to accommodate the seating of the wedges.</p>

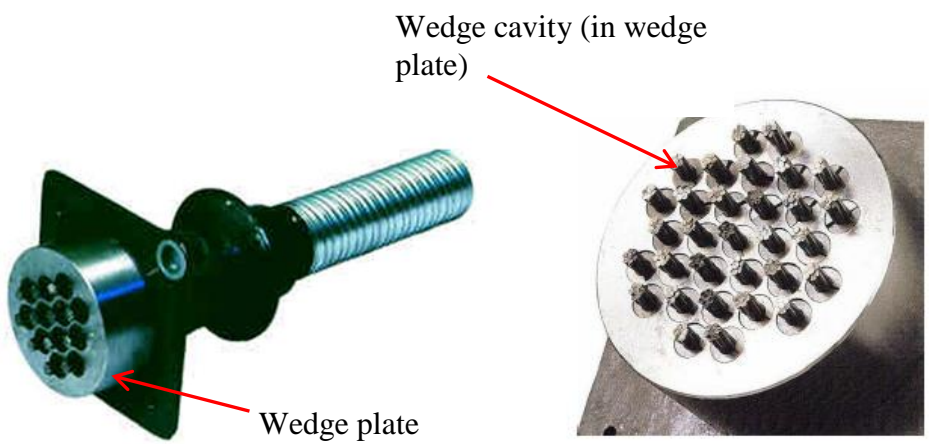
<p>Wedge plate</p>	<p>For multistrand tendons, a device that houses the wedges and transfers the prestressing force to a bearing plate.</p> 
--------------------	---

Equipment

Stressing equipment

Equipment used for stressing tendons, consisting of a hydraulic jack and gauge(s) calibrated as a unit, and a hydraulic pump.

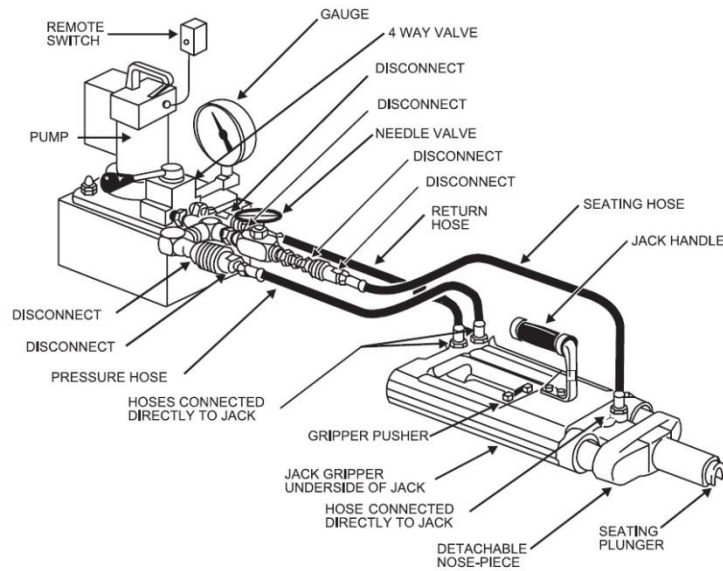

Stressing equipment for single strands

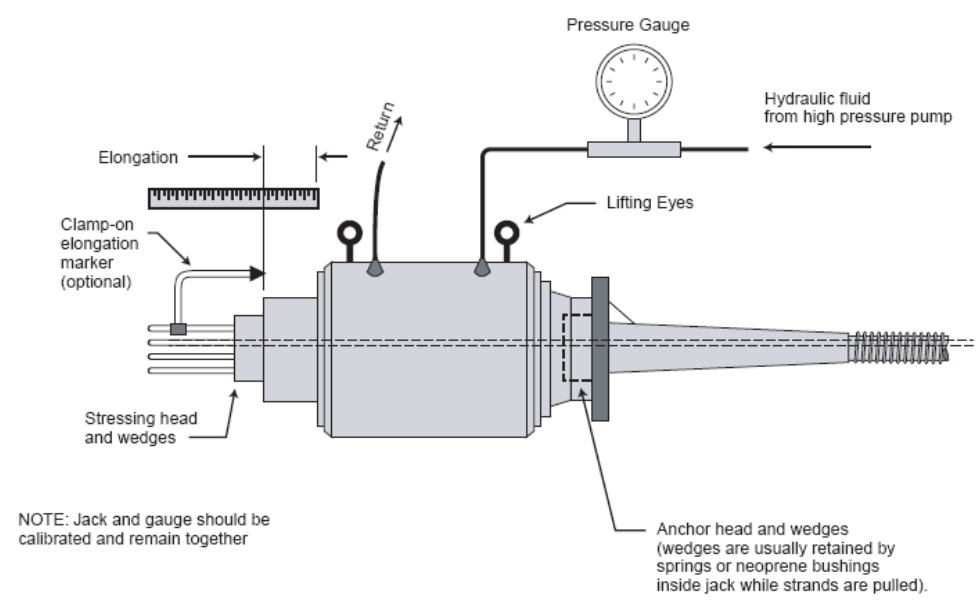

Stressing Equipment for multistrand tendons



Stressing equipment for stress bars

Grippers

Special wedges used in the single strand jack to hold the strand during the stressing operation.



Hand seating tool

For unbonded single strand tendons, a handheld device used to pre-seat the wedges in the anchor before stressing.

Jack, monostrand

A mechanical device (normally hydraulic) used to apply force to a single strand.



Nosepiece

The front part of the monostrand jack that bears against the anchor in order to align

the jack with the tendon.

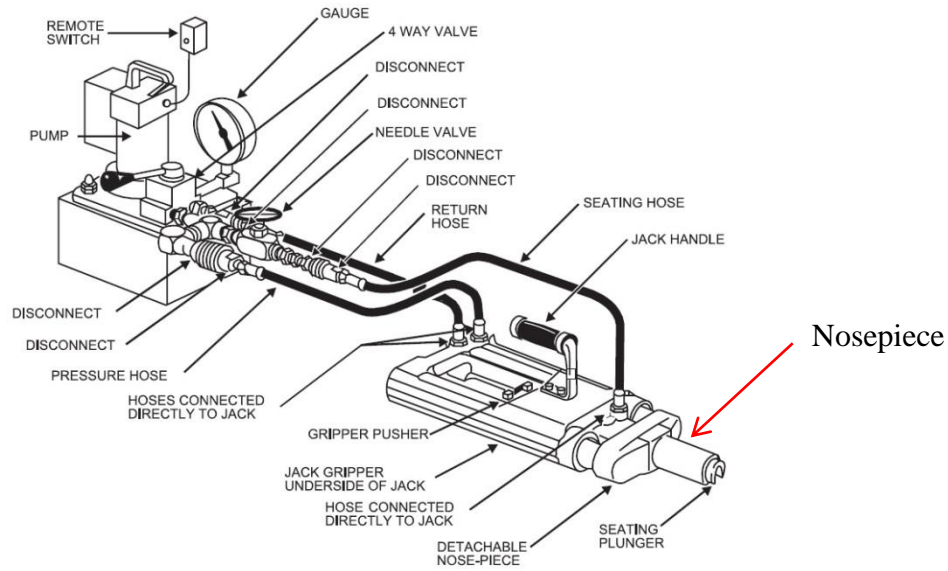

Wedge pipe

For multistrand tendons, a handheld pipe used to pre-seat the wedges in the wedge plate before stressing.

Tendon Stressing	
Anchor set	The movement of the wedges into the anchor or wedge plate, or nut into the bearing plate during the transfer of the prestressing force to the anchorage assembly.
Blowout	A localized concrete failure resulting from tendon forces, which occurs in the vicinity of the anchorage(s) or at tendon deviation points during or after stressing.
Jacking force	The specified temporary force exerted by the stressing jack on the tendon during stressing.
Lift off	A field procedure used to determine the actual force in a tendon at the point where the procedure is executed.
Partial stressing	Stressing of tendons to a force less than the full jacking force before the concrete reaches the concrete strength required for full stressing. Normally used to mitigate cracking due to plastic shrinkage and restraint to shortening.
Stage stressing	Stressing of tendons at different times instead of stressing at one time.

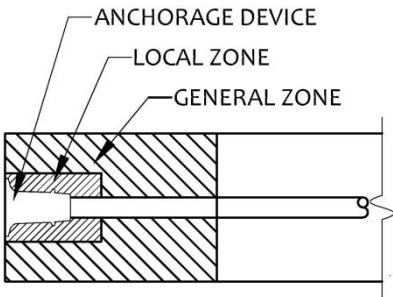
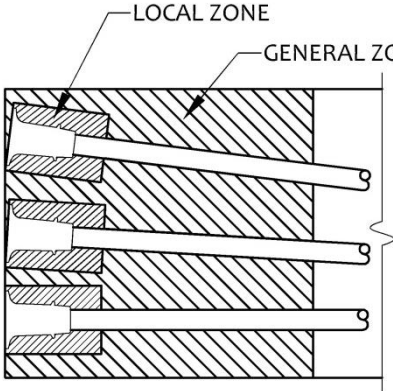
Design	
Anchorage zone	<p>The portion of the member through which the concentrated prestressing force is transferred to the concrete and distributed across the section. It includes the local and general anchorage zones.</p> <p>For anchorage devices located away from the end of the member, the anchorage zone includes the disturbed regions behind and ahead of the anchorage.</p>
Local anchorage zone	<p>The prismatic region in which the concentrated prestressing force is introduced into the concrete, surrounding the bearing plate including confinement reinforcement and the minimum concrete cover. The length of the local anchorage zone extends over the confinement reinforcement.</p> <div style="text-align: center;">  <p>Labels: ANCHORAGE DEVICE, LOCAL ZONE, GENERAL ZONE</p> </div>
General anchorage zone	<p>The region in which the concentrated prestressing force spreads out over the cross section of the structural member (Saint Venant Region). It includes the local anchorage zone. The general anchorage zone extends from the anchorage along the axis of the member for a distance equal to the overall depth of the member. The height of the general anchorage zone is equal to the overall depth of the member.</p> <div style="text-align: center;">  <p>Labels: LOCAL ZONE, GENERAL ZONE</p> </div>
Balanced moments	Moments caused by balanced loads.
Balanced loads	Loads applied to the member by the prestressing tendon.

<p>Barrier cable</p>	<p>A vehicular barrier and/or pedestrian guard consisting of a group of parallel high-strength steel strands.</p> 
<p>Eccentricity</p>	<p>Distance between the center of gravity of the concrete cross-section and center of gravity of the prestressing steel (CGS) at any point along the length of a member.</p>
<p>Elongation</p>	<p>Increase in length of prestressing steel due to the stressing force.</p>
<p>Friction loss</p>	<p>The loss of force in prestressing steel resulting from friction between the prestressing steel and its enclosure, affected by the angular deviation of the tendon.</p>
<p>Effective Prestress</p>	<p>Stress in a member due to final effective force.</p>
<p>Final effective force</p>	<p>Force in prestressing steel after all prestress losses.</p>
<p>Initial losses</p>	<p>The loss of force in a prestressing tendon that occurs during stressing resulting from friction losses, elastic shortening of concrete, and seating loss.</p>
<p>Initial stress</p>	<p>Stress in the prestressing steel immediately after anchor set.</p>
<p>Hydrogen embrittlement</p>	<p>Brittle cracking in high-strength steels caused by the conjoint action of tensile stress and the presence of a solution containing hydrogen ions (atomic hydrogen).</p>
<p>Licensed design professional</p>	<p>(LDP); An engineer or architect who is licensed to practice as defined by the statutory requirements of the professional licensing laws of a state or jurisdiction and who is responsible for the structural design and the preparation of contract documents for the work.</p>
<p>Post-tensioning</p>	<p>Method of prestressing in which prestressing steel is tensioned after concrete has</p>

(PT)	hardened.
PT Installation Drawings	Drawings furnished by the PT supplier showing information about the specifics of the PT system and tendon placement including, but not limited to the number, size, length, marking, location, elongation and profiles.
PT supplier	Contracting entity responsible for furnishing and delivering to the job site all components of the PT system including PT installation drawings and stressing equipment.
Post-tensioning system (PTS)	A tendon of a particular size, including prestressing steel, anchorages, local anchorage zone reinforcement, duct, trumpets, couplers, grout caps, inlets, outlets, etc. all supplied by a single PT supplier.
Prestressed concrete	Structural concrete in which internal compressive stresses are induced by means of prestressed reinforcement to reduce tensile stresses in the concrete due to applied loads.
Prestressing steel	High-strength steel used to prestress concrete, consisting of seven-wire strands, bars, wires, or groups of such elements.
Pretensioning	Method of prestressing in which prestressing steel is tensioned before the concrete is placed.
Primary moments	Prestressing force multiplied by eccentricity at any point along the tendon profile.
Seating loss	The loss of force in prestressing steel resulting from anchor set.
Secondary effects	Moments, shears and axial loads generated in an indeterminate member as a result of restraint of the member's supports to free movement of the member due to prestressing.
Secondary moments	Moments caused by reactions to balanced loads only.
Tendon support system	The support bars, chairs, slab bolsters and other accessories required to maintain the tendon profile.
Tendon profile	The specified path of a tendon from end to end in a member.

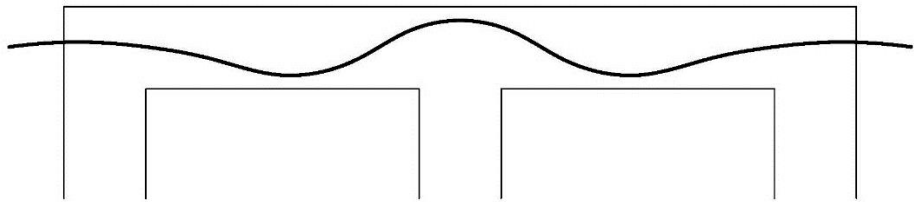

Time dependent losses	The loss of force in a prestressing tendon that occurs over time resulting from concrete shrinkage and creep, and relaxation in the prestressing steel.
Wobble friction	Friction due to unintended angular deviations in the tendon profile.
Yield strength	The stress at which a material exhibits a specific limiting deviation from the proportionality of stress to strain.

Troubleshooting / Repair

Anchor, troubleshooting

A special anchor used for structural modification or repair of existing unbonded single strand tendons, consisting of a removable segment which allows the special anchor to be installed onto an existing continuous strand. The removed segment is then returned and held in place by screw or bolt.

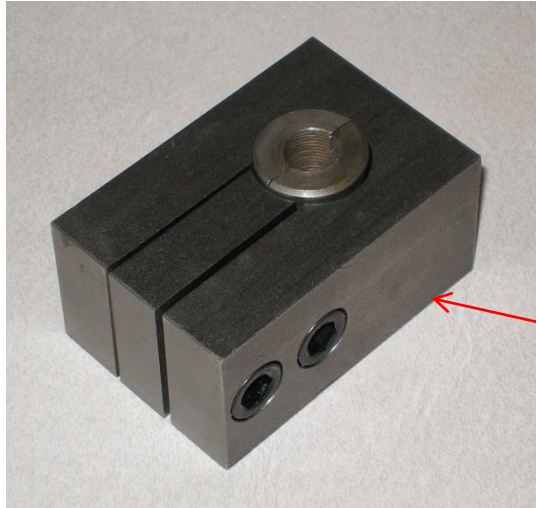

Troubleshooting Anchor (shown with wedges)

Coupler

A device used to connect the ends of tendons making them structurally continuous.



Single strand coupler

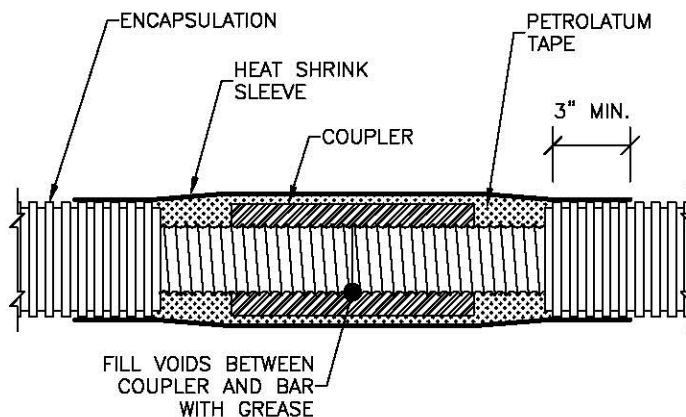

Stress bar coupler

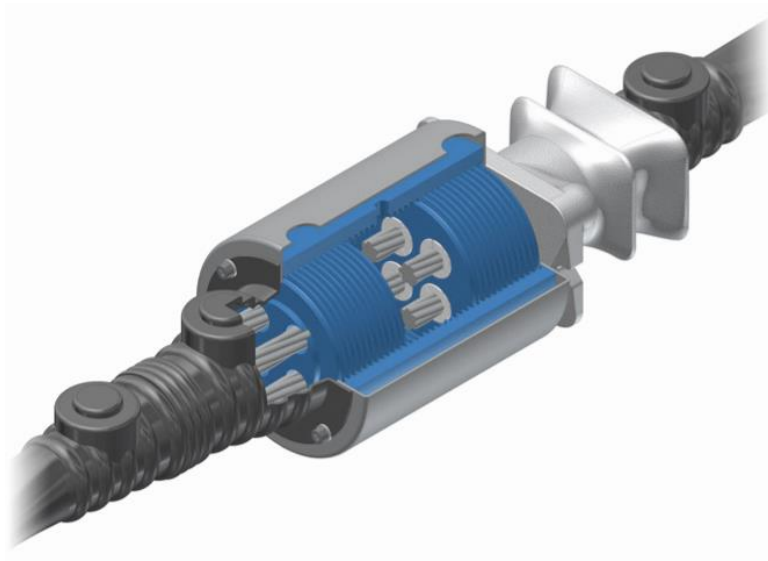

Multistrand coupler

Detensioning

A method for releasing the force in a stressed tendon.

Concrete / Grouting Materials	
Bleed	The autogenous flow of mixing water within, or its emergence from, newly placed grout; caused by the settlement of the solid materials within the mass and filtering action of strands, wires and bars.
Final Set	A degree of stiffening of the grout mixture greater than the initial set, indicating the time in hours and minutes required for the grout to stiffen sufficiently to resist, to an established degree, the penetration of a weighted test needle.
Fluidity	A measure of time, expressed in seconds necessary for a stated quantity of grout to pass through the orifice of the flow cone.
Grout	A mixture of cementitious materials and water, with or without mineral additives, admixtures or fine aggregate, proportioned to produce a pumpable consistency without segregation of the constituents injected into the duct to fill the space around the prestressing steel.
Initial set	A degree of stiffening of the grout mixture less than the final set, indicating the time in hours and minutes required for the grout to stiffen sufficiently to resist, to an established degree, the penetration of a weighted test needle.
Set time	The lapsed time from the addition of mixing water to a cementitious mixture until the mixture reaches a specified degree of rigidity as measured by a specific procedure.
Setting	The process, due to the chemical reactions, occurring after the addition of mixing water, which results in a gradual development of rigidity of a cementitious mixture.
Thixotropic	The property of a material that enables it to stiffen in a short time while at rest, but to acquire a lower viscosity when mechanically agitated. The process is reversible.

Index

Added tendon	17	Jacking force	25
Anchor.....	1	Licensed design professional	27
Anchor nut	3	Lift off.....	25
Anchor set	25	Local anchorage zone	26
Anchor, barrel	3	Local zone reinforcement	12
Anchor, troubleshooting	30	Monostrand (Single Strand).....	12
Anchorage (assembly)	4	Multistrand.....	13
Anchorage zone	26	Nosepiece	24
Anchorage, fixed.....	6	Outlet.....	13
Anchorage, intermediate	5	Partial stressing	25
Anchorage, stressing	7	Pocket former.....	13
Back-up bars	8	Post-tensioning (PT)	28
Balanced loads	26	Post-tensioning system (PTS).....	28
Balanced moments	26	Prestressed concrete	28
Banded tendons.....	18	Prestressing steel.....	28
Barrier cable.....	27	Pretensioning.....	28
Bearing plate, basic.....	2	Primary moments	28
Bearing plate, special	2	PT Installation Drawings	28
Bleed	32	PT supplier	28
Blowout.....	25	Seating loss	28
Bonded tendon	16	Secondary effects	28
Bursting steel	9	Secondary moments	28
Confinement reinforcement	10	Set time	32
Coupler.....	30	Setting	32
Detensioning	31	Sheathing.....	14
Distributed tendons	18	Slab bolster.....	14
Duct.....	11	Stage stressing.....	25
Eccentricity	27	Strand	14
Effective Prestress.....	27	Strand tail	15
Elongation	27	Stress bar.....	15
Encapsulated tendon	17	Stressing equipment	22
Final effective force	27	Stressing pocket	16
Final Set	32	Temperature tendon	17
Fluidity	32	Tendon	16
Friction loss.....	27	Tendon profile.....	29
General anchorage zone	26	Tendon support system	28
Grippers.....	23	Tendon tail	19
Grout	32	Thixotropic.....	32
Hand seating tool	23	Time dependent losses	29
Hydrogen embrittlement	27	Trumpet.....	20
Initial losses	27	Unbonded tendon	16
Initial set.....	32	Wedge cavity	20
Initial stress	27	Wedge pipe	24
Inlet	11	Wedge plate	21
Jack, monostrand.....	23	Wedges.....	20



Wobble friction 29
Yield strength..... 29